



Matrox® MaeveX™ Series

7112A Encoder • 7112H Encoder
6152 Decoder • 6152 Encoder • 6122 Encoder
• 6100 Encoder
• 5150 Encoder • 5150 Decoder

User Guide

20245-301-0400
2024.02.06

Contents

Matrox safety information	5
Installation and operation	5
If a power supply (internal or external) was included with your product	6
If your product includes laser-based technology	6
If your product includes a battery	6
Repair	7
Overview	8
Hardware supplied	8
Software available	8
Hardware required (not included)	8
Optional hardware (not included)	9
Matrox rack mount kit	10
Installation overview	10
More information	11
Getting started	12
Understanding your Maevox environment	12
Setting up your Maevox environment	13
Connecting your Maevox 7112 encoder	15
Connection overview	15
Description of buttons and supported connections	16
Connecting your Maevox 6152 decoder	17
Connection overview	17
Description of supported connections	18
Menu buttons	20
Scroll buttons	21
Connecting your Maevox 6152 encoder	22
Connection overview	22
Description of supported connections	24
Programmable buttons	26
LCD control buttons	26
Connecting your Maevox 6122 encoder	28
Connection overview	28

Description of supported connections	30
Programmable buttons	32
LCD control buttons	32
Installing and connecting your Maevox 6100 encoder	34
Before you begin	34
Step-by-step installation	34
Installing multiple cards	35
Connecting your Maevox 6100 encoder	36
Description of supported connections	36
Connecting your Maevox 5150 decoder	37
Connection overview	37
Description of supported connections	38
Daisy chaining your Maevox 5150 decoders	39
Connecting your Maevox 5150 encoder	40
Connection overview	40
Description of supported connections	41
Validating your Maevox setup	43
Description of LEDs – Maevox 7112 encoder	43
Description of LEDs – Maevox 6100 Series	44
Description of LEDs – Maevox 5100 Series	46
Validating network discovery	47
Rebooting or resetting your Maevox device	48
When to reboot or reset your device	48
Software reboot (PowerStream Plus)	48
Hardware reboot or configuration reset	49
Installing Matrox PowerStream Plus software	51
Before you begin	51
Obtaining Matrox PowerStream Plus software	52
Installing your software	52
Accessing Matrox PowerStream Plus software	52
Connecting to Maevox 7112 devices using a web browser	52
Additional resources	52
More information	53

Troubleshooting	54
What to do if you have a problem	54
Common problems and solutions	54
Product information	56
Specifications	56
Analog audio	64
External power supply	65
Environmental	65
Supported standards	66
Notes and limitations	66
Appendix A – Firewall requirements	68
PowerStream Plus software	68
Firmware updater	68
Maevex devices	69
Accessing your Windows Firewall settings	70
Adding rules to your Windows Firewall settings	70
Appendix B – Providing adequate airflow to your Maevex device	72
Appendix C – Installing your Matrox secure cable solution for cards	73
Appendix D – Installing your Matrox secure cable solution for appliances	76
HDMI	76
Customer support	78
Matrox Web	78
Technical support	78
Firmware package	78
View your warranty information	78
View the third party software notices	79
Register your Matrox product	79

Matrox safety information



To ensure safe and reliable operation of your Matrox product, to avoid personal injury, and to prevent damage to your computer or Matrox hardware, read the following guidelines.

Installation and operation

- Read and retain all instructions. Only use your Matrox product according to the instructions, operating ranges, and guidelines provided in the Matrox user guide and other related Matrox documentation. Failure to follow these instructions could result in damage to your product or injury to the user or installer.

- Don't expose your Matrox product to rain, water, condensation, or moisture.

- **Caution: Hot Surface, Do Not Touch**

Your Matrox product can become hot while operating. Ensure that your computer cover is secured in place before turning it on.



Always turn off your computer, unplug it, and then wait for it to cool before removing the cover of your computer to touch any of its internal parts or to install your Matrox card. Allow hot surfaces to cool before touching your Matrox unit.

- **Attention: Surface chaude, ne pas toucher**

Votre produit Matrox peut devenir chaud durant son fonctionnement. Assurez-vous de bien fermer le couvercle de votre ordinateur avant de l'allumer.



Éteignez votre ordinateur, débranchez-le et attendez qu'il refroidisse avant d'ouvrir son couvercle pour accéder à ses parties internes ou pour installer votre carte Matrox. Laissez les surfaces chaudes refroidir avant de toucher votre appareil Matrox.

- Static electricity can severely damage electronic parts. Before touching any electronic parts, drain static electricity from your body (for example, by touching the metal frame of your computer).
- When handling a card, carefully hold it by its edges and avoid touching its circuitry.
- Don't stack devices or place devices so close together that they're subject to recirculated or preheated air.
- Don't operate your system or Matrox product near a heat source or restrict airflow to your system, and make sure the ambient temperature doesn't exceed the maximum recommended temperatures. Don't block ventilation holes on your unit or system.

If a power supply (internal or external) was included with your product

- Don't place the external power supply directly on top of the device.
- Only use power supplies originally supplied with the product or use a replacement that's approved by Matrox. Don't use the power supply if it appears to be defective or has a damaged chassis.
- Any AC-powered product must be connected to a grounded outlet installed by a licensed electrician. Don't defeat the safety purpose of the polarized or grounding-type plug. A polarized plug has two blades with one wider than the other. A grounding-type plug has two blades and a third grounding prong. The wide blade or the third prong are provided for your safety. If the provided plug doesn't fit into your outlet, consult a licensed electrician to replace the obsolete outlet.
- Make sure that nothing rests on the power cables and that the cables aren't located where they can be stepped on, pinched, or tripped over.
- Don't use damaged power cables.
- Unplug your system or device during lightning storms or if unused for long periods of time.

If your product includes laser-based technology

- The device contains a Class 1 laser product for use only under the recommended operating conditions and guidelines. For more information, see your Matrox user guide.
- Invisible laser radiation may be emitted from disconnected fibers or connectors. Don't stare into beams or view directly with optical instruments.
- Only use optical transceivers originally supplied with the product or use a replacement that's approved by Matrox.
- For more information on laser support and compliance, see your Matrox user guide.

If your product includes a battery

- The battery is non-replaceable.
- To dispose of your product, see www.matrox.com/environment/weee.



Repair

- Don't attempt to open or repair a power supply unit (if one was supplied).
- Don't attempt to open or repair your Matrox product.
- If there's a fault with your Matrox product, review your Matrox warranty for more information.

Overview

Thank you for purchasing a Matrox MaeveX 7100, 6100, or 5100 Series product. Matrox MaeveX products are designed for single- or multi-channel, real-time encoding, live streaming, and recording applications.

Hardware supplied*

Depending on your MaeveX product, the following hardware is supplied:

- MaeveX 7112A Encoder – Encoder device, 1 power supply.
- MaeveX 7112H Encoder – Encoder device, 1 power supply.
- MaeveX 6152 Decoder – Decoder device, 1 power supply.
- MaeveX 6152 Encoder – Encoder device, 1 power supply.
- MaeveX 6122 Encoder – Encoder device, 1 power supply.
- MaeveX 6100 Encoder – Encoder card.
- MaeveX 5150 Encoder – Encoder device, 1 power supply, 1 DVI to HDMI® adapter, 1 CAT 5e network cable (6 ft/1.8 m), 1 analog audio cable.
- MaeveX 5150 Decoder – Decoder device, 1 power supply.

Software available

- **Matrox PowerStream Plus** – to use your Matrox product. Matrox PowerStream Plus software supports Windows® Server® 2022, Windows® Server® 2019, Windows® 11 (64-bit) and Windows® 10 (64-bit).

Hardware required (not included)

MaeveX 7112 Encoder

- Network cable (CAT 5, 5e, 6, or 7)
- Certified high-speed HDMI cable (Premium high-speed for 4K60 resolution)

MaeveX 6152 Decoder

* The hardware supplied with your Matrox product may vary depending on the SKU or part number of your product. For more information, contact your Matrox representative.

- Network cable (CAT 5, 5e, 6, or 7)
- Certified high-speed HDMI cable (Premium high-speed for 4K60 resolution)

Maevex 6152 Encoder or 6122 Encoder

- Network cable (CAT 5, 5e, 6, or 7)
- Certified high-speed HDMI cable (Premium high-speed for 4K60 resolution)

Maevex 6100 Encoder

- Network cable (CAT 5, 5e, 6, or 7)
- Shielded HDMI cable or certified high-speed HDMI cable

Maevex 5150 Encoder

- Shielded HDMI cable or certified high-speed HDMI cable

Maevex 5150 Decoder

- Network cable (CAT 5, 5e, 6, or 7)
- Shielded HDMI cable or certified high-speed HDMI cable

Optional hardware (not included)

Depending on your connection setup, you may also need any of the following hardware:

Maevex 7112 Encoder

- Certified high-speed HDMI cable (Premium in case of 4K60 resolution)
- Analog audio cable
- DVI to HDMI adapter
- DisplayPort™ to HDMI adapter
- Matrox secure cable solution

Maevex 6152 Decoder

- Analog audio cable
- HDMI to DVI adapter
- Matrox secure cable solution

Maevex 6152 Encoder or 6122 Encoder

- Network cable (CAT 5, 5e, 6, or 7)
- Certified high-speed HDMI cable (Premium in case of 4K60 resolution)

- Analog audio cable
- DVI to HDMI adapter
- DisplayPort™ to HDMI adapter
- Matrox secure cable solution

Maevox 6100 Encoder

- Matrox secure cable solution

Maevox 5150 Encoder

- Network cable (CAT 5, 5e, 6, or 7)
- Shielded HDMI cable or certified high-speed HDMI cable (Encoder device to monitor)
- VGA cable
- Analog audio cable

Maevox 5150 Decoder

- Analog audio cable
- DVI to HDMI adapter

Matrox rack mount kit

Matrox makes available a rack mount kit to mount your Maevox devices. To purchase a Matrox rack mount kit, contact your Matrox representative.

Installation overview

To install your Matrox product:

- 1 Install your Maevox 6100 encoder – see “Installing and connecting your Maevox 6100 encoder”, page 34.
- 2 Connect your product.
 - Maevox 7112 Encoder – see “Connecting your Maevox 7112 encoder”, page 15.
 - Maevox 6152 Decoder – see “Connecting your Maevox 6152 decoder”, page 17.
 - Maevox 6152 Encoder – see “Connecting your Maevox 6152 encoder”, page 22.
 - Maevox 6122 Encoder – see “Connecting your Maevox 6122 encoder”, page 28.
 - Maevox 6100 Encoder – see “Connecting your Maevox 6100 encoder”, page 36.
 - Maevox 5150 Decoder – see “Connecting your Maevox 5150 decoder”, page 37.

- **Maevox 5150 Encoder** – see “Connecting your Maevox 5150 encoder”, page 40.
- 3** Validate your setup – see “Validating your Maevox setup”, page 43.
 - 4** Install the software – see “Installing Matrox PowerStream Plus software”, page 51. For more information on PowerStream Plus software, see the Matrox PowerStream Plus User Guide.

More information

Your Matrox user guide provides information on installing and connecting your Matrox hardware. For information on other Matrox software features and options, see the documentation for that software.

For information on how to use and configure PowerStream Plus software, see the Matrox PowerStream Plus User Guide.

Be sure to check for any last-minute release notes included with your product. Also, check the Matrox web site (<https://video.matrox.com>) for the latest Matrox software, technical support, and product information.

Getting started

This section provides an overview of your Maevox environment and devices.

Understanding your Maevox environment

Matrox Maevox devices work together to provide unicast (one-to-one), multicast (one-to-many), or multi-unicast (one-to-many unicast) streaming over an IP network. Using Matrox PowerStream Plus software, you can manage your entire Maevox network from a single system or multiple systems.

A Matrox Maevox environment can be made up of the following elements connected to a network:

6152 Encoder example

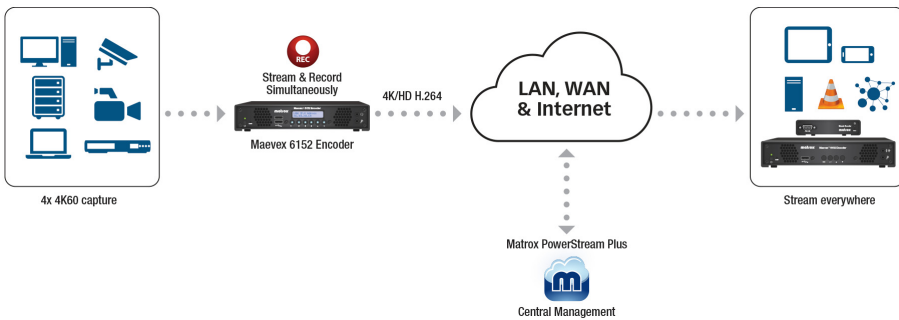

7112A Encoder example

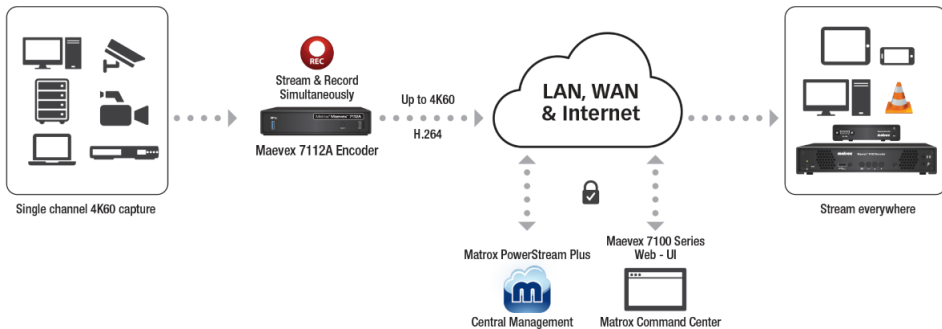

Source	A video (and audio) source connected to the input of an encoder. A controller system also can be used as a source.
Maevox 7112 encoders	Single-channel AVC (7112A) and AVC/HEVC (7112H) ultra-high compression, low latency video encoders that capture, encode, stream and record 4K(UHD) and Full HD channels over IP.
Maevox 6152 decoder	A quad-output 4K decoder appliance that works with the entire Maevox product line as well as third-party encoders. Efficiently decodes up to four 4K streams, or many more lower resolution streams.
Maevox 6152 encoder	An encoder appliance that supports four (4) 4K60 inputs with HDCP and can generate multiple streams and recordings. An encoder can stream to one or more decoders.
Maevox 6122 encoder	An encoder appliance that supports two (2) 4K60 inputs with HDCP and can generate multiple streams and recordings. An encoder can stream to one or more decoders.
Maevox 6100 encoder	An encoder card with multiple input support that can generate multiple streams and recordings. An encoder can stream to one or more decoders.
Maevox 5150 encoder	An encoder with single input support that can generate a single stream or recording. An encoder can stream to one or more decoders.
Maevox 5150 decoder	A decoder with a single Full HD output that decodes and displays any Maevox or third-party encoder's RTSP stream that is available on the network. A decoder is needed for each stream from an encoder in your environment.
Third-party decoder	Third-party video players (such as VideoLAN® VLC media player) can also be used to decode the signal from an encoder.
Recording location	The location (such as a Network Attached Storage (NAS) device or a network shared folder) used by a Maevox encoder to record a file.
Controller system	A system connected to the network and running Matrox PowerStream Plus software. A controller system can be used as a source.

Setting up your Maevox environment

Before connecting your devices, we recommend you have the following:

- A DHCP (Dynamic Host Configuration Protocol) server
- A DNS (Domain Name System) server
- A controller system

- At least one output device (monitor or HDTV) to preview your video sources
- At least one source
- Maevex 6152 decoder - Access to an NTP server

Adding a device to your environment

Before adding a decoder or an encoder to your Maevex environment, we recommend you perform a configuration reset of your Matrox device. This resets the IP address and any other settings that may prevent you from using the device in your environment.

For more information on performing a configuration reset of your device see [“Rebooting or resetting your Maevex device”](#), page 48

Connecting your Maevox 7112 encoder

This section describes how to connect your Maevox 7112 encoder.

Connection overview

This section provides an overview of the connections, buttons, and indicators available on the device.



Note: Although the Maevox 7112A is shown below, the functionality is the same for both the 7112A and the 7112H models.

Maevox 7112 encoder (Front)



Maevox 7112 encoder (Back)



Description of buttons and supported connections

Connector	Description
USB 3.0	Not currently supported (except for USB 3.0 power delivery).
Reset	Performs a hardware reboot or configuration reset of your device. For more information, see “Rebooting or resetting your Maevex device” on page 48.
Status indicators	See “Description of LEDs – Maevex 7112 encoder” on page 43.
12V d.c. 2A power	Connect the 12V d.c. 3.33A power supply included with your product to this connector. While the power supply is connected to the device and electrical socket, the power LED () is active (not black). For more information on LEDs, see “Description of LEDs – Maevex 7112 encoder” on page 43.
LAN	Connect a network cable to this connector.
HDMI OUT HDMI IN	<p>HDMI In – Connect your video source to this connector. If your video source doesn’t support HDMI output, use an HDMI adapter to connect it to your encoder. If your video source has a DVI connector, use the DVI to HDMI adapter included with your Maevex product to connect it to your encoder.</p> <p>Note: We recommend you use a certified high-speed (premium highspeed for 4K60) HDMI cable.</p> <p>HDMI Out (Optional) – This output represents a passthrough of the HDMI input for all the HDMI capabilities supported by the Maevex encoder devices. Connect a digital monitor to this connector. If your digital monitor has a DVI connector, you need an HDMI to DVI-D adapter to connect your monitor to this connector.</p> <p>Note: We recommend you use a certified high-speed (premium highspeed for 4K60) HDMI cable.</p>
Analog audio input	Optional – Connect your analog audio source to this connector.

For information on installing your Matrox software, see [“Installing Matrox PowerStream Plus software”, page 51.](#)

Connecting your Maevox 6152 decoder

This section describes how to connect your Maevox 6152 decoder.

Connection overview

This section provides an overview of the connections available on the device.

Maevox 6152 decoder (Front)

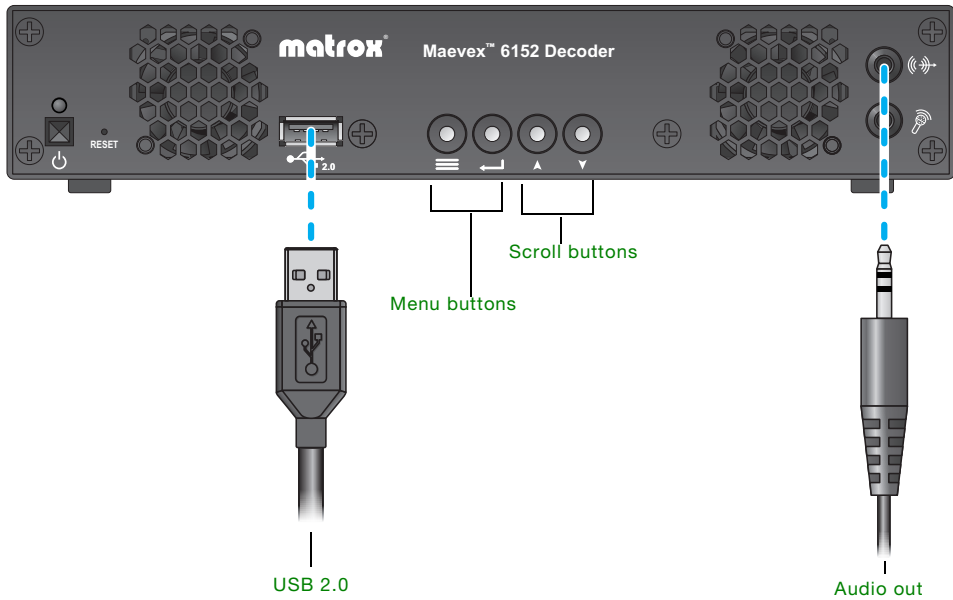

Maevex 6152 decoder (Back)

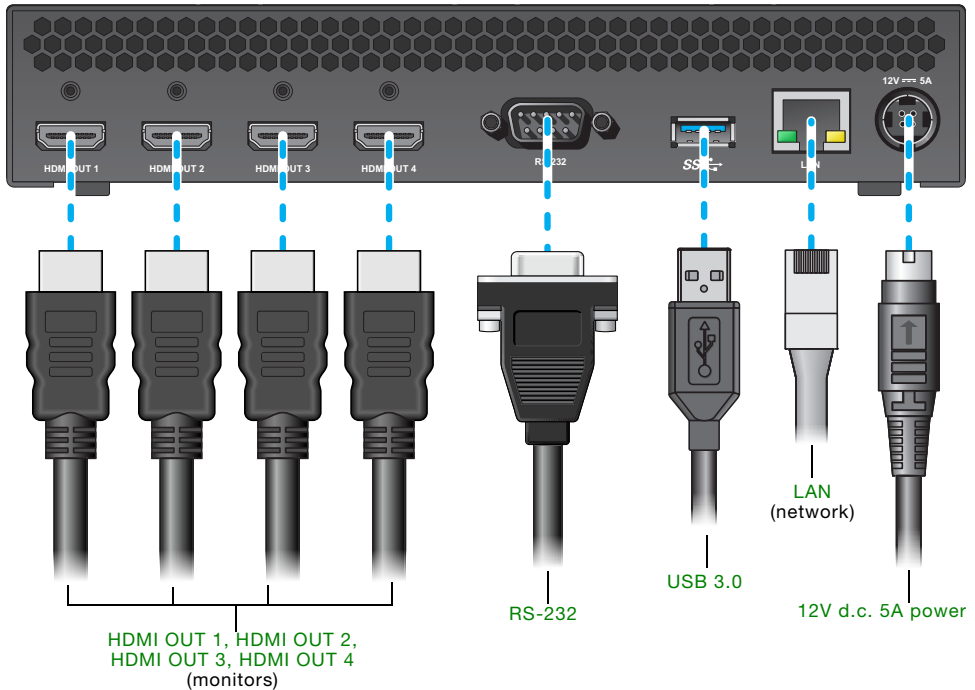

Description of supported connections

Connector	Description
12V d.c. 5A power	Connect the 12V d.c. 5A power supply included with your product to this connector. While the 12V d.c. 5A power supply is connected to the device and electrical socket, the power LED () is active (not black). For more information on LEDs, see “Maevex 6152 decoder, 6152 encoder, or 6122 encoder”, page 44.
HDMI OUT 1, HDMI OUT 2, HDMI OUT 3, HDMI OUT 4	Connect digital monitors to these four HDMI out connectors. If your digital monitor has a DVI connector, you need an HDMI to DVI-D adapter to connect your monitor to this connector. Note: To connect to this connector, you need a certified high-speed HDMI cable. For 4Kp60, you need a premium certified high-speed HDMI cable.
Audio out	Optional – Connect your analog audio device to this connector.
LAN	Connect a network cable to this connector.
Microphone in	Currently not supported.





Connector	Description
RS-232	<p>Optional – To control a third-party device (such as a display) over RS-232 through the Maevox 6152 decoder, connect the two devices using a RS-232 serial cable. Use a straight through or null modem RS-232 serial cable depending on your third-party device as well as the origin of the RS-232 commands (via physical RS-232 controller, or a direct RS-232 over IP application).</p> <p>If you are controlling from a physical RS-232 controller device, connect it to your Maevox encoder device using a straight through serial cable, and in PowerStream Plus, set the Relayed serial over IP option for your encoder. You can do this through any Maevox encoder appliance (Maevox 6100 Series encoder or the Maevox 5150 encoder).</p> <p>If you are controlling directly from a RS-232 over IP application, set the Direct serial over IP option in PowerStream Plus for your Maevox 6152 decoder device.</p>
USB 2.0	<p>Connect a USB storage device (such as a flash drive) to this connector. This can be used for local storage of recorded streams, such as the stream for failsafe. The file system supported is NTFS, and the file formats supported are MP4, FMP4, JPG, and PNG.</p>
USB 3.0	<p>Connect a USB storage device (such as an external hard drive) to this connector. This can be used for local storage of recorded streams, such as the stream for failsafe. The file system supported is NTFS, and the file formats supported are MP4, FMP4, JPG, and PNG.</p> <p>Note: External hard drives must be connected to this connector, unless they are externally powered.</p>

For information on installing your Matrox software, see [“Installing Matrox PowerStream Plus software”](#), page 51.

Menu buttons





The menu buttons enable you to display information about the device and the decoded content on the screens.

Menu 	Press the first  button to display the main menu on all the screens. The main menu options are Select region for full-screen viewing and Device information . The menu displays for about ten (10) seconds and disappears if no other button is pressed within this time. If the menu is already displayed on screen, pressing the button again removes the menu from the screen. You can also use the Menu button to go back to the main menu when a sub-menu is displayed. When you are in a full-screen preview, you can press the Menu button to exit the full-screen preview mode. Note: If debug information is displayed on the screen, when the first button is pressed, the debug information disappears and is replaced by the menu on the screen. <ul style="list-style-type: none">▪ Select region for full-screen viewing - Select the monitor and sub-panel whose stream needs to be displayed on full screen using the up or down arrow button.▪ Device information – Displays the device information on each screen such as the product name, serial number, IP address, device and monitor count, and more.
Enter 	Press the second  button to select the function highlighted on the menu.

View decoded content on full screen

To view decoded content on full screen:

- 1 Press the Menu  button on the device. The main menu displays on all the screens with the **Select region for full-screen viewing** and **Device information** options.
- 2 When on the **Select region for full-screen viewing** option select it by pressing the Enter  button. The monitor contour of the first monitor is highlighted.
- 3 Navigate among the monitors using the up and down arrow buttons.
- 4 Press the Enter button to select the highlighted monitor. The contour blinks three times to show that the monitor is selected. You will then be taken to the panel selection mode.
- 5 Navigate to the desired panel whose content needs to be viewed in full screen using the up and down arrow buttons.

- 6 Select the panel by pressing the second button. The panel content is displayed on full screen.



Note: This is a temporary preview and not a permanent output configuration. The output configuration set in PowerStream Plus is preserved.

Scroll buttons



The (▲) and (▼) buttons enable you to scroll through the menu options. When you select some menu options, you may have to make further choices (for example, a particular monitor, panel, or video). The up and down buttons let you navigate towards your choice (forward or back; left or right; go to the previous or next item).

UP (▲)	Press the (▲) button to scroll up the list of menu options. When an option requires you to make another selection for performing the task, press the up button to navigate back (to the left), towards the item of your choice.
DOWN (▼)	Press the (▼) button to scroll down the list of menu options. When an option requires you to make another selection for performing the task, press the down button to navigate forward (to the right), towards the item of your choice.

Connecting your Maevox 6152 encoder

Connection overview



Note: Don't change connections while your Maevox device is turned on. If connections are changed while your Maevox device is turned on, your video sources will be lost.

Maevox 6152 encoder (Front)

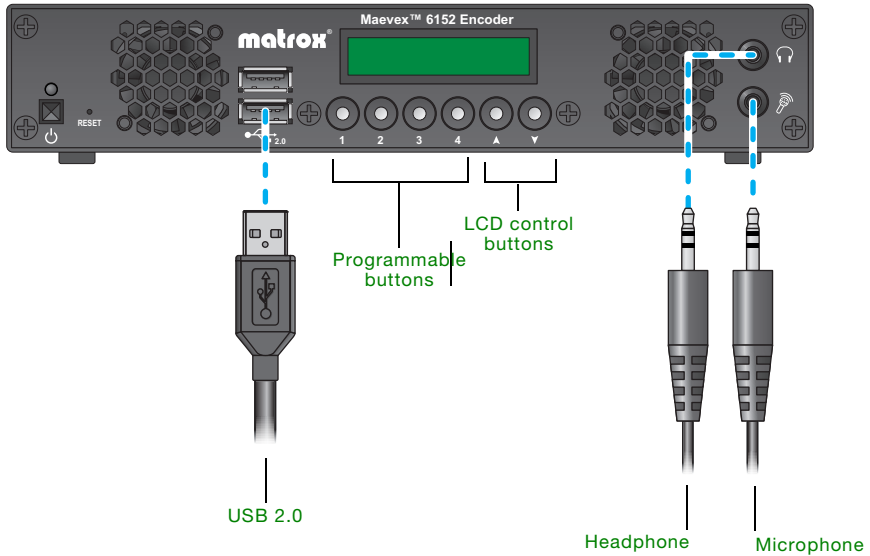

Maevex 6152 encoder (Back)

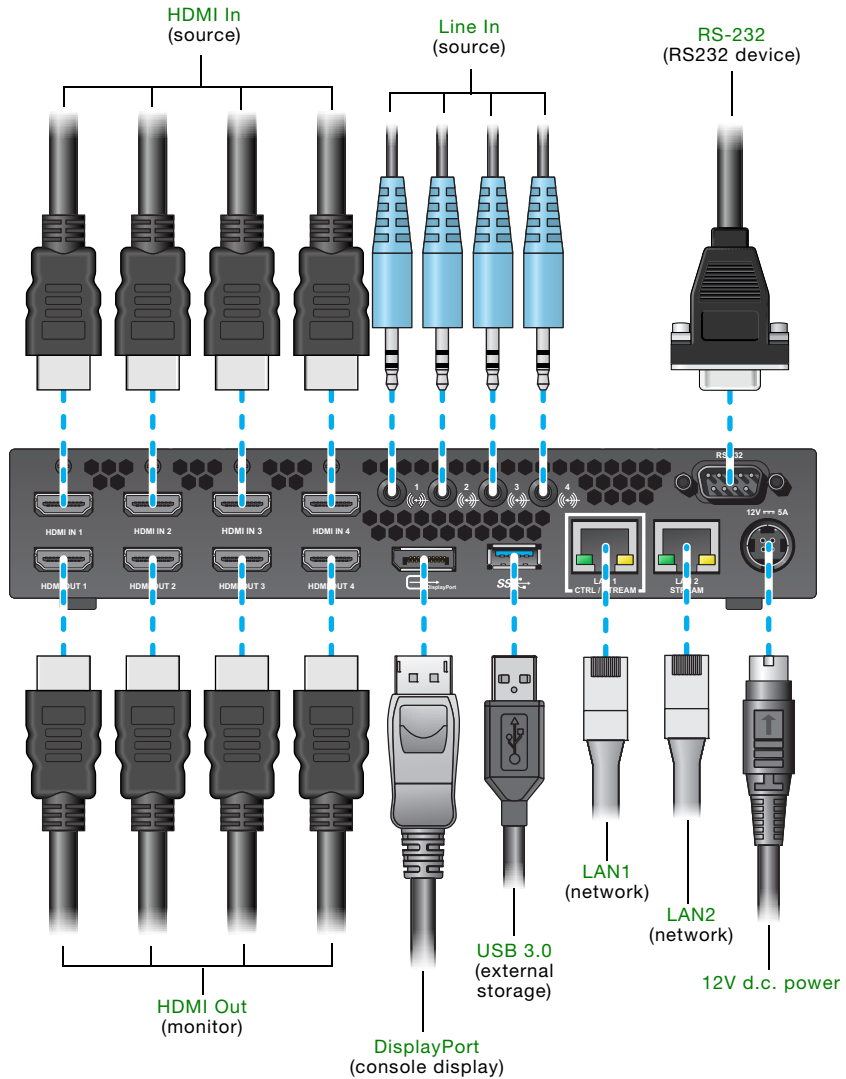

Description of supported connections

Connector	Description
12V d.c. power	Connect the 12V d.c. power supply included with your product to this connector. While the 12V d.c. power supply is connected to the device and electrical socket, the power LED () is active (not black). For more information on LEDs, see “Description of LEDs – Maevox 6100 Series”, page 44.
DisplayPort	Optional – Connect a DisplayPort monitor to this connector to use as a console display. You can use a console display to preview your video sources. If your monitor has an HDMI connector, you need a DisplayPort to HDMI adapter to connect your monitor to this connector. If your monitor has a DVI connector, you need a DisplayPort to DVI-D adapter to connect your monitor to this connector.
Headphone	Optional – Connect your headphones to this connector.
HDMI In	Connect your video source to this connector. If your video source doesn't support HDMI output, use an HDMI adapter to connect it to your encoder. If your video source has a DVI connector, use the DVI to HDMI adapter included with your Maevox product to connect it to your encoder. Note: We recommend you use a certified high-speed (premium high-speed for 4K60) HDMI cable.
HDMI Out	Optional – These outputs represent a passthrough of their respective HDMI inputs for all the HDMI capabilities supported by the Maevox encoder devices. Connect a digital monitor to this connector. If your digital monitor has a DVI connector, you need an HDMI to DVI-D adapter to connect your monitor to this connector. Note: We recommend you use a certified high-speed (premium high-speed for 4K60) HDMI cable.
LAN1	Connect a network cable to this connector. This connector is used for controlling and streaming.
LAN2	Optional – If you're using multiple subnets, connect a network cable to this connector. This connector is used for secondary streaming. Note: To obtain the MAC address of LAN2, increment the MAC address of LAN1 by 1. To obtain the MAC address of LAN1, check the label on the bottom of the device or on the packaging. Note: Daisy chaining isn't supported.
Line In	Optional – Connect the analog audio output of your video source to this connector.
Microphone	Optional – Connect your microphone to this connector.

Connector	Description
RS-232	<p>Optional – Connect the Maevox encoder appliance and your third-party RS-232 device using a RS-232 serial cable. Use a straight through or a null modem RS-232 serial cable depending on your third-party device.</p> <p>To control a third-party device (such as an A/V source) over RS-232 through a Maevox encoder appliance, select the Direct serial over IP option in PowerStream Plus for your Maevox 6152 or 6150 encoder appliance and control directly from the RS-232 over IP control application of your third-party device. If you are connecting a physical RS-232 controller device in order to control a third-party RS-232 device connected to one of your Maevox decoders, select the Relayed serial over IP option of your encoder in PowerStream Plus. You can also use the RS232 API to issue start or stop recording and/or streaming, and rebooting the device. For more information on the decode-side configuration, refer to the Maevox decoder sections in this user guide.</p>
USB 2.0	Connect a USB storage device (such as a flash drive) to this connector.
USB 3.0	<p>Connect a USB storage device to this connector.</p> <p>Note: External hard drives must be connected to this connector, unless they are externally powered.</p>

After connecting your Maevox encoder, we recommend you validate your connection setup before you continue (see [“Validating your Maevox setup”](#), page 43). After you validate your setup, install your Matrox software (see [“Installing Matrox PowerStream Plus software”](#), page 51).

Programmable buttons

You can assign a button (labeled **1, 2, 3, 4**) to a module (**HDMI input, Streams, or Recordings**) in your PowerStream Plus software. You can also control the local preview using a button.

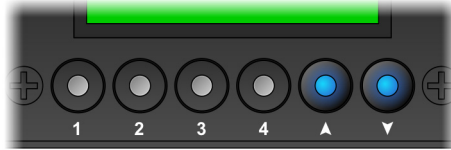

LED color	Description
No LED (black)	Button isn't assigned. OR Button is assigned, but no PowerStream Plus module is set to Enable . In PowerStream Plus, make sure all the modules assigned to a button are set to Enable .
Blue (solid)	Button is assigned, and all PowerStream Plus modules are set to Enable .
Blue (blinking)	Button is assigned, but some of the modules are set to Enable and some are set to Disable . To synchronize your modules, press the button that's blinking.

For more information on assigning a button and enabling modules, see the Matrox PowerStream Plus user guide.

LCD control buttons



Note: The LCD goes into power saving mode approximately 10 minutes after the last device power-on, configuration reset, or reboot, or after the last push of the LCD control buttons. In power saving mode, the LED of the LCD control buttons is solid blue.

The (▲) and (▼) buttons enable you to access the LCD display and scroll through a list of messages.

Accessing the LCD display

UP (▲)	Press the (▲) button to scroll up the list of messages.
DOWN (▼)	Press the (▼) button to scroll down the list of messages.
UP (▲) + DOWN (▼)	Press the (▲) and (▼) buttons at the same time to scroll a message horizontally.

Message list

The LCD lists information on your Maevex device (such as the name, firmware version, device temperature, and IP address).

Connecting your Maevox 6122 encoder

Connection overview



Note: Don't change connections while your Maevox device is turned on. If connections are changed while your Maevox device is turned on, your video sources will be lost.

Maevox 6122 encoder (Front)

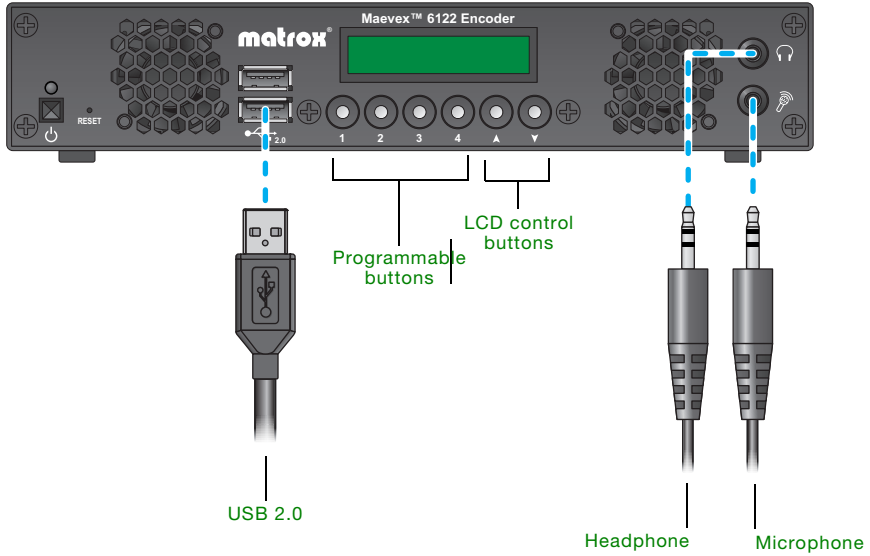

Maevex 6122 encoder (Back)

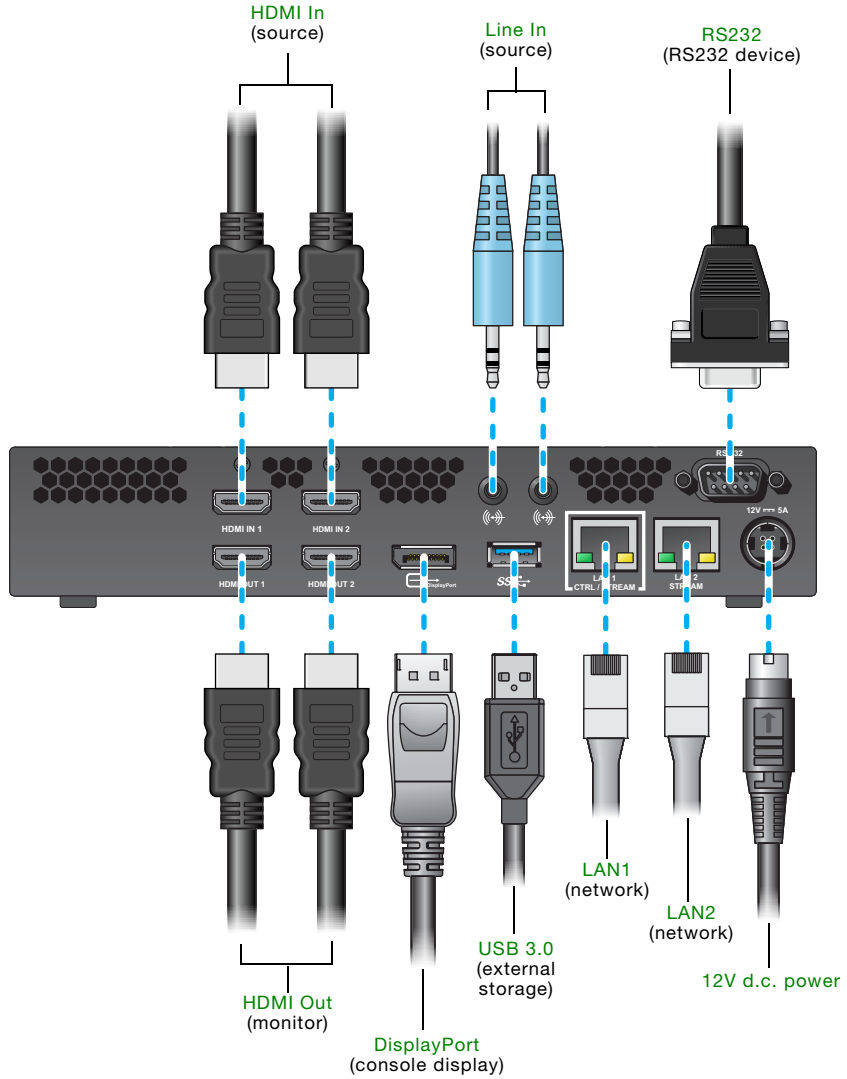

Description of supported connections

Connector	Description
12V d.c. power	Connect the 12V d.c. power supply included with your product to this connector. While the 12V d.c. power supply is connected to the device and electrical socket, the power LED () is active (not black). For more information on LEDs, see “Description of LEDs – Maevox 6100 Series”, page 44.
DisplayPort	Optional – Connect a DisplayPort monitor to this connector to use as a console display. You can use a console display to preview your video sources. If your monitor has an HDMI connector, you need a DisplayPort to HDMI adapter to connect your monitor to this connector. If your monitor has a DVI connector, you need a DisplayPort to DVI-D adapter to connect your monitor to this connector.
Headphone	Optional – Connect your headphones to this connector.
HDMI In	Connect your video source to this connector. If your video source doesn't support HDMI output, use an HDMI adapter to connect it to your encoder. If your video source has a DVI connector, use the DVI to HDMI adapter included with your Maevox product to connect it to your encoder. Note: We recommend you use a shielded HDMI cable.
HDMI Out	Optional – These outputs represent a passthrough of their respective HDMI inputs for all the HDMI capabilities supported by the Maevox encoder devices. Connect a digital monitor to this connector. If your digital monitor has a DVI connector, you need an HDMI to DVI-D adapter to connect your monitor to this connector. Note: We recommend you use a shielded HDMI cable.
LAN1	Connect a network cable to this connector. This connector is used for controlling and streaming.
LAN2	Optional – If you're using multiple subnets, connect a network cable to this connector. This connector is used for secondary streaming. Note: To obtain the MAC address of LAN2, increment the MAC address of LAN1 by 1. To obtain the MAC address of LAN1, check the label on the bottom of the device or on the packaging. Note: Daisy chaining isn't supported.
Line In	Optional – Connect the analog audio output of your video source to this connector.
Microphone	Optional – Connect your microphone to this connector.

Connector	Description
RS232	<p>Optional – Connect the Maevox encoder appliance and your third-party RS-232 device using a RS-232 serial cable. Use a straight through or a null modem RS-232 serial cable depending on your third-party device.</p> <p>To control a third-party device (such as an A/V source) over RS-232 through a Maevox encoder appliance, select the Direct serial over IP option in PowerStream Plus for your Maevox 6122 or 6120 encoder appliance and control directly from the RS-232 over IP control application of your third-party device. If you are connecting a physical RS-232 controller device in order to control a third-party RS-232 device connected to one of your Maevox decoders, select the Relayed serial over IP option of your encoder in PowerStream Plus. You can also use the RS232 API to issue start or stop recording and/or streaming, and rebooting the device. For more information on the decode-side configuration, refer to the Maevox decoder sections in this user guide.</p>
USB 2.0	Connect a USB storage device (such as a flash drive) to this connector.
USB 3.0	<p>Connect a USB storage device to this connector.</p> <p>Note: External hard drives must be connected to this connector, unless they are externally powered.</p>

After connecting your Maevox encoder, we recommend you validate your connection setup before you continue (see [“Validating your Maevox setup”](#), page 43). After you validate your setup, install your Matrox software (see [“Installing Matrox PowerStream Plus software”](#), page 51).

Programmable buttons

You can assign a button (labeled **1, 2, 3, 4**) to a module (**HDMI input, Streams, or Recordings**) in your PowerStream Plus software. You can also control the local preview using a button.

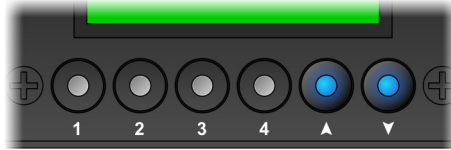

LED color	Description
No LED (black)	Button isn't assigned. OR Button is assigned, but no PowerStream Plus module is set to Enable . In PowerStream Plus, make sure all the modules assigned to a button are set to Enable .
Blue (solid)	Button is assigned, and all PowerStream Plus modules are set to Enable .
Blue (blinking)	Button is assigned, but some of the modules are set to Enable and some are set to Disable . To synchronize your modules, press the button that's blinking.

For more information on assigning a button and enabling modules, see the Matrox PowerStream Plus user guide.

LCD control buttons



Note: The LCD goes into power saving mode approximately 10 minutes after the last device power-on, configuration reset, or reboot, or after the last push of the LCD control buttons. This mode is identified by a persistent blue LED of the LCD control buttons.

The (▲) and (▼) buttons enable you to access the LCD display and scroll through a list of messages.

Accessing the LCD display

UP (▲)	Press the (▲) button to scroll up the list of messages.
DOWN (▼)	Press the (▼) button to scroll down the list of messages.
UP (▲) + DOWN (▼)	Press the (▲) and (▼) buttons at the same time to scroll a message horizontally.

Message list

The LCD lists information on your Maevex device (such as the name, firmware version, device temperature, and IP address).

Installing and connecting your Maevox 6100 encoder

This section describes how to install and connect your Matrox card. If your Matrox card is already installed in your system, skip to [“Connecting your Maevox 6100 encoder”](#), page 36. For information specific to your system, like how to remove its cover, see your system manual.

Before you begin

To avoid personal injury and to prevent damage to your system or Matrox hardware, read the following guidelines before installing and connecting your Matrox hardware.

Preventing damage to your hardware

- While your system is turned off but still plugged in, some electrical current is supplied to the motherboard. This current may prevent newly installed hardware from working properly.
- Always try to insert or remove your card as straight as possible.
- Whenever you change your connection setup, make sure you’re using the correct connectors and that all connectors are properly fastened.
- When connecting devices, make sure the connectors are properly fastened.
- Review the safety information provided. For more information, see [“Matrox safety information”](#), page 5.

Step-by-step installation

1 Choose an expansion slot

Most systems have different types of expansion slots. Choose a PCI Express® ×8 or ×16 (PCIe®) slot. Your system manual should identify the location of each type of expansion slot in your system.

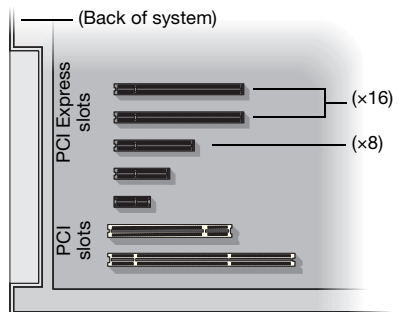

2 Insert your Matrox card

- a Position your Matrox card over the expansion slot you've chosen.
- b Push the card in firmly and evenly until it's fully seated in the slot.
- c Secure the bracket of your Matrox card to the frame of your system.

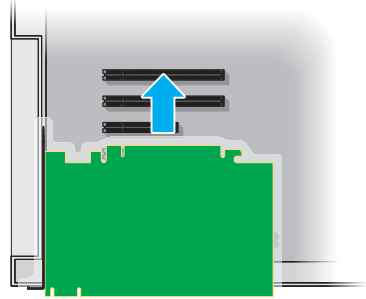

Your Matrox card is now installed. If you're installing more than one card, see [“Installing multiple cards”](#), page 35. *Before restarting your system*, connect your devices (see the “Connection setup” section for the card you want to connect). *After connecting*, restart your system and install your Matrox software.

Installing multiple cards

Your system may support the installation of multiple Maevox cards in your system.



WARNING: To avoid damaging your cards, always insert your card as straight as possible into the slot. Don't rock the card from side to side. If you meet resistance, don't force the card into the slot.

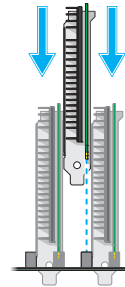

Connecting your Maevex 6100 encoder

Connection overview

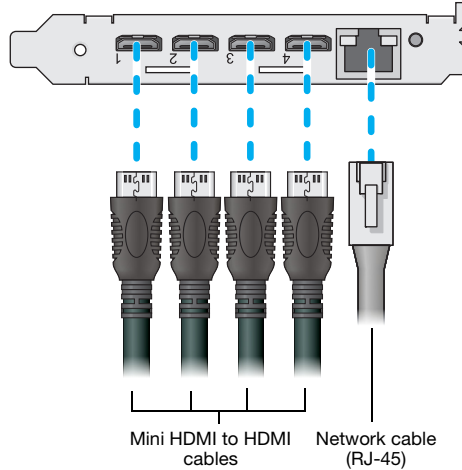

Description of supported connections

Connector	Description
HDMI	Attach your mini HDMI to HDMI cable to your Matrox card. Connect the other end of the cable to your video device. Note: To use this connector, you need a shielded HDMI cable. If your video source uses a display resolution higher than 720p60, we recommend you use a certified high-speed HDMI cable.
Network (RJ-45)	Connect your network cable to your Matrox card to stream to an IP network.



Note: To connect to the bracket of your Matrox product, the overmold (or boot) of the mini HDMI connectors must respect the maximum width (0.551 inches/14 mm) and thickness (0.331 inches/8.4 mm) stated in the HDMI specifications.

Your Matrox card is now installed and connected. Restart your system and install your Matrox software (see “[Installing Matrox PowerStream Plus software](#)”, page 51).

Connecting your Maevox 5150 decoder

This section describes how to connect your Maevox 5150 decoder.

Connection overview

Maevox 5150 decoder (Front)

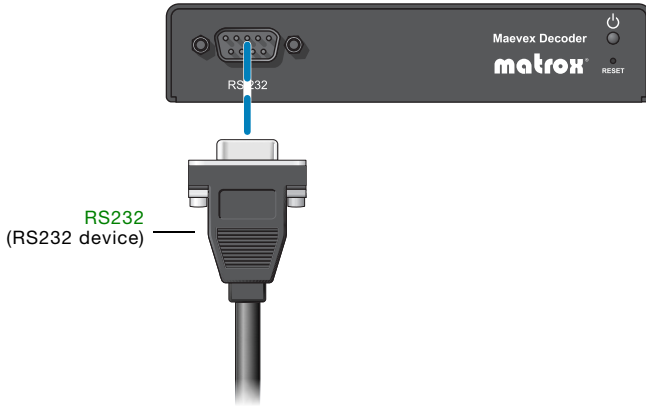

Maevox 5150 decoder (Back)

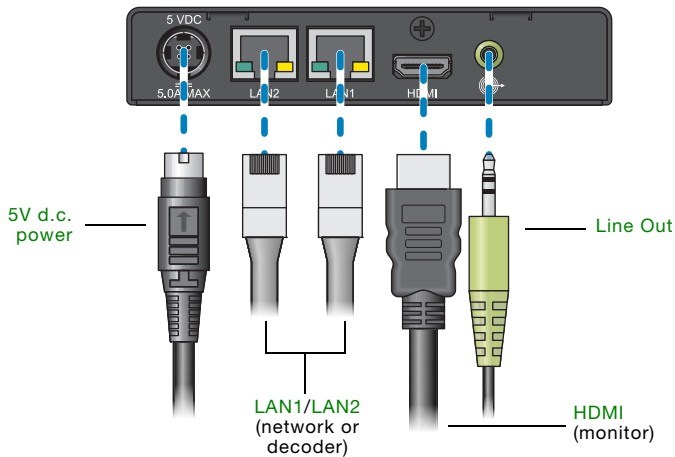

Description of supported connections

Connector	Description
5V d.c. power	Connect the 5V d.c. power supply included with your product to this connector. While the 5V d.c. power supply is connected to the device and electrical socket, the power LED () is active (not black). For more information on LEDs, see “Description of LEDs – Maevox 5100 Series”, page 46.
HDMI	Connect a digital monitor to this connector. If your digital monitor has a DVI connector, you need an HDMI to DVI-D adapter to connect your monitor to this connector. Note: We recommend you use a shielded HDMI cable.
HDMI In	Connect your video source to this connector. If your video source doesn't support HDMI output, use an HDMI adapter to connect it to your encoder. If your video source has a DVI connector, use the DVI to HDMI adapter included with your Maevox product to connect it to your encoder. Note: We recommend you use a shielded HDMI cable.
HDMI Out	Optional – Connect a digital monitor to this connector. If your digital monitor has a DVI connector, you need an HDMI to DVI-D adapter to connect your monitor to this connector. Note: We recommend you use a shielded HDMI cable.
LAN1	Connect a network cable to this connector. Note: You can only use the second network connector on the decoder to daisy chain the 5150 decoders.
LAN2	
Line In	Optional – Connect the analog audio output of your video source to this connector. If you're using HDMI audio input, this connector is disabled.
Line Out	Optional – Connect your analog audio output device (such as speakers) to this connector.
RS232	Optional – To control an RS232 device (such as a monitor) on one of your 5150 decoders with an RS232 controller connected to an encoder or with an RS232 controller sending commands over the network. <ul style="list-style-type: none"> ▪ 5150 encoder – Connect one end of your RS232 serial cable to the connector on your encoder. Connect the other end of the serial cable to your RS232 device. <ul style="list-style-type: none"> ▪ If your encoder is set to use the Relayed serial over IP feature in PowerStream Plus, use a straight through serial cable to connect your RS232 device to your encoder. ▪ If your encoder is set to use the Direct serial over IP feature in PowerStream Plus, use the opposite of the serial cable required by your RS232 device. (For example, if your RS232 device requires a null modem cable, use a straight through cable instead.) ▪ 5150 decoder – Connect one end of your RS232 serial cable to the connector on your decoder. Connect the other end of the serial cable to your RS232 device. For this connection, use the serial cable (null modem or straight through) required by your RS232 device. <p>If your RS232 device has a DB25 connector, use a DE9 (also known as a DB9) to DB25 converter to connect your device to this connector.</p>

For information on installing your Matrox software, see “Installing Matrox PowerStream Plus software”, page 51.

Daisy chaining your MaeveX 5150 decoders

You can daisy chain the network connections for your decoders by connecting one decoder to another.

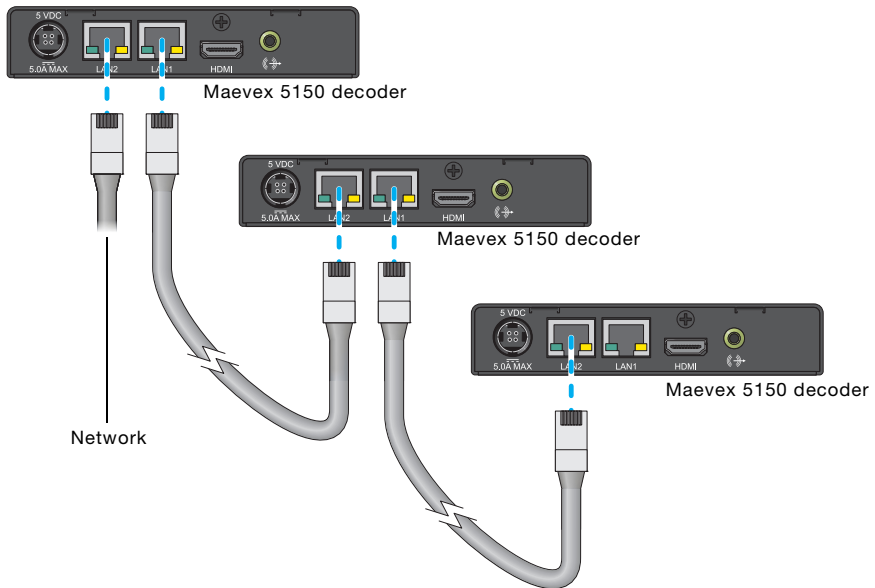

When daisy chaining decoders, consider the following:

- For daisy chaining to work from one decoder to another, a decoder must be powered. If power is lost, the connection to the next decoder is also lost.
- When daisy chaining network connections, the maximum number of decoders that can be connected together is ten (10). Depending on your hardware and network settings, the number of decoders you can daisy chain on the same network jack may be lower.

Connecting your Maevox 5150 encoder

This section describes how to connect your Maevox 5150 encoder.

Connection overview

Maevox 5150 encoder (Back)

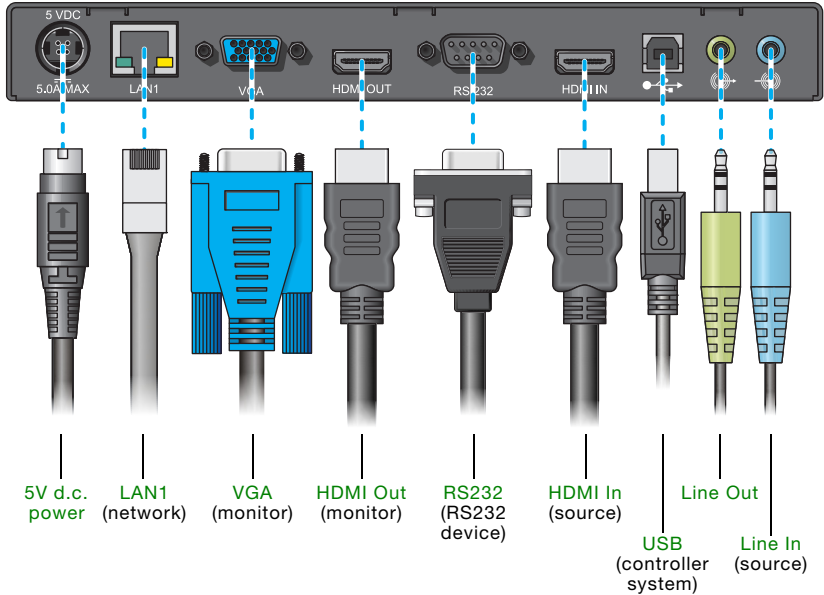

Description of supported connections

Connector	Description
5V d.c. power	Connect the 5V d.c. power supply included with your product to this connector. While the 5V d.c. power supply is connected to the device and electrical socket, the power LED () is active (not black). For more information on LEDs, see “Description of LEDs – Maevox 5100 Series”, page 46.
HDMI	Connect a digital monitor to this connector. If your digital monitor has a DVI connector, you need an HDMI to DVI-D adapter to connect your monitor to this connector. Note: To use this connector, you need a shielded HDMI cable. If your video source uses a display resolution higher than 720p60, we recommend you use a certified high-speed HDMI cable.
HDMI In	Connect your video source to this connector. If your video source doesn't support HDMI output, use an HDMI adapter to connect it to your encoder. If your video source has a DVI connector, use the DVI to HDMI adapter included with your Maevox product to connect it to your encoder. Note: To use this connector, you need a shielded HDMI cable. If your video source uses a display resolution higher than 720p60, we recommend you use a certified high-speed HDMI cable.
HDMI Out	Optional – Connect a digital monitor to this connector. If your digital monitor has a DVI connector, you need an HDMI to DVI-D adapter to connect your monitor to this connector. Note: To use this connector, you need a shielded HDMI cable. If the video output of your device uses a display resolution higher than 720p60, we recommend using a certified high-speed HDMI cable.
LAN1	Connect a network cable to this connector.
Line In	Optional – Connect the analog audio output of your video source to this connector. If you're using HDMI audio input, this connector is disabled.
Line Out	Optional – Connect your analog audio output device (such as speakers) to this connector.

Connector	Description
RS232	<p>Optional – To control an RS232 device (such as a monitor) on one of your 5150 decoders with an RS232 controller connected to an encoder or with an RS232 controller sending commands over the network.</p> <ul style="list-style-type: none"> ▪ Encoder – Connect one end of your RS232 serial cable to the connector on your encoder. Connect the other end of the serial cable to your RS232 device. ▪ If your encoder is set to use the Relayed serial over IP feature in PowerStream Plus, use a straight through serial cable to connect your RS232 device to your encoder. ▪ If your encoder is set to use the Direct serial over IP feature in PowerStream Plus, use the opposite of the serial cable required by your RS232 device. (For example, if your RS232 device requires a null modem cable, use a straight through cable instead.) ▪ Decoder – Connect one end of your RS232 serial cable to the connector on your decoder. Connect the other end of the serial cable to your RS232 device. For this connection, use the serial cable (null modem or straight through) required by your RS232 device. <p>If your RS232 device has a DB25 connector, use a DE9 (also known as a DB9) to DB25 converter to connect your device to this connector.</p>
SD™ Card	<i>Currently not supported.</i>
USB	<i>Currently not supported.</i>
VGA	<p>Optional – Connect an analog monitor to this connector. For local viewing of uncompressed video from your video source.</p>

For information on installing your Matrox software, see [“Installing Matrox PowerStream Plus software”](#), page 51.

Validating your Maevox setup

After connecting your Maevox devices, we recommend you validate your connection setup and network discovery before you continue.

Description of LEDs – Maevox 7112 encoder

The LED on your Maevox device provides information to help you troubleshoot your Maevox 7112 product. The following describes the LEDs on your Maevox device.

LED	What it means
PWR	On/Off indicator. <ul style="list-style-type: none">■ Green – Unit is powered on.
STAT	Multi-purpose system status indicator. <ul style="list-style-type: none">■ Boot Sequence – If the encoder can't find a DHCP server, it won't get network settings and the LED will blink amber for 60 seconds. If it still can't connect, the encoder will use a default IP address (169.x.x.x) and the LED will stay amber. If it finds a DHCP server later, the encoder gets an IP address and the LED turns green.■ Overheating – When overheating occurs, a slow red blink signals the device has reached a critical temperature; it will reset to basic functions after 60 seconds, resuming full operation once the temperature is back to normal. A fast red blink indicates a severe temperature issue, leading to a complete shutdown after 30 seconds, requiring manual power-up to restart.■ Restoring System Defaults – See “Rebooting or resetting your Maevox device” on page 48.
LCK	Video lock indicator. When the encoder detects a supported video standard the LED will be lit as follows: <ul style="list-style-type: none">■ Red – Standard definition (SD)■ Amber – High definition (HD, FHD)■ Green – 4K (UHD)
ACT	Streaming activity indicator. <ul style="list-style-type: none">■ Blinking Green – Streaming is active.

Network connector

The network connectors on your product use indicator lights (LEDs) to provide information on the network activity and presence. The following describes the different network connector LEDs.

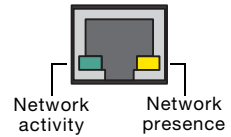

LED color	Network activity	Network presence
No LED (black)	No data transfer in progress or no network detected.	No communication established.
Green (flashing)	Data transfer in progress.	—
Green (solid)	—	Network communication established.

Description of LEDs – Maevox 6100 Series

The LED on your Maevox device provides information to help you troubleshoot your Maevox 6100 Series product. The following describes the LEDs on your Maevox device.

Maevox 6152 decoder, 6152 encoder, or 6122 encoder

LED color	6152 decoder, 6152 encoder, or 6122 encoder
No LED (black)	Device isn't powered.
Green (standby)	Device is turned off but is powered.
Green (solid)	Device is active.
Green (slow blink)	Device is rebooting.
Green (fast blink)	Configuration reset in progress.
Amber (solid)	Device is in maintenance mode.
Amber (slow blink)	Device is restarting and is in maintenance mode.
Amber (fast blink)	Device is updating the firmware.
Red (solid)	Device has detected a fatal error. Try rebooting your device. If, after restarting your device, the LED is still red, contact your vendor for technical support (see “Customer support”, page 78).

Maevex 6100 encoder

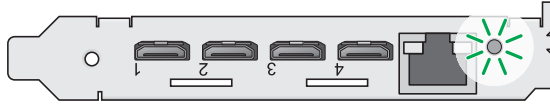

LED color	6100 encoder
No LED (black)	Device isn't powered. Make sure your card is properly installed. Also, make sure your system isn't in power saving mode (see "Step-by-step installation", page 34). For more information, contact your vendor (see "Customer support", page 78).
Green (solid)	Card is active.
Green (slow blink)	Card is rebooting.
Green (fast blink)	Configuration reset in progress.
Amber (solid)	Card is in maintenance mode.
Amber (slow blink)	Card is rebooting and is in maintenance mode.
Amber (fast blink)	Card is updating the firmware.
Red (solid)	Card has detected a fatal error. Try restarting your system. If, after restarting your system, the LED is still red, contact your vendor for technical support (see "Customer support", page 78).

Network connector

The network connectors on your product use indicator lights (LEDs) to provide information on the network activity and presence. The following describes the different network connector LEDs.

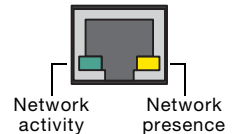

LED color	Network activity	Network presence
No LED (black)	No network activity detected (network cable unplugged).	Transmitting at 1 Gbps.
Green (flashing)	Network activity detected.	—
Amber (solid)	—	Transmitting at 100 Mbps.

Description of LEDs – Maevex 5100 Series

The LED on your Maevex device provides information to help you troubleshoot your Maevex 5100 Series product. The following describes the LEDs on your Maevex device.

Maevex 5150 encoder and 5150 decoder

The power LED () on your Matrox Encoder or Decoder unit provides information on the status of your unit. The following describes the power LEDs on your Maevex unit.

LED color	5150 encoder	5150 decoder
No LED (black)	Unit isn't powered.	Unit isn't powered.
Green/Red (flashing)	Unit is initializing.	Unit is initializing.
Green	Unit is ready.	Unit is ready.
Green (flashing)	Encoding and streaming.	Decoding network stream.
Red (flashing)	No valid audio/video input signal detected.	Unit isn't in use.
Red	Fatal error detected.	Fatal error detected.
Amber	Unit reset to factory default. Unit requires maintenance.	Unit reset to factory default. Unit requires maintenance.
Amber (flashing)	Configuring or updating firmware.	Configuring or updating firmware.

Network connector

The network connectors on your product use indicator lights (LEDs) to provide information on the network activity and presence. The following describes the different network connector LEDs.

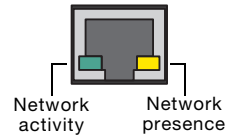

LED color	Network activity	Network presence
No LED (black)	No data transfer in progress or no network detected.	No communication established.
Green (flashing)	Data transfer in progress.	—
Amber	—	Network communication established.

Validating network discovery

Maevox devices are initially assigned their IP addresses through DHCP (Dynamic Host Control Protocol). After connecting your devices, we recommend verifying that all of your devices are discovered by the network.

To make sure all of your devices are discovered by the network:

- **Windows 10** – Click **Start** → **File Explorer** → **Network**. Under **Other Devices**, make sure all the Maevox devices connected are listed.

If prompted to enable network discovery and file sharing on your network when validating network discovery, enable these two features by clicking on the prompt at the top of your Windows Explorer window. These two features must be enabled for PowerStream Plus software to detect the Maevox devices.

After validating your connection setup, install Matrox PowerStream Plus software (see [“Installing Matrox PowerStream Plus software”](#), page 51).

Rebooting or resetting your Maevox device

This section describes how to *reboot* or perform a *configuration reset* of your Maevox device.

When to reboot or reset your device

What to do...	When to do it...	What the result is...
Software reboot (PowerStream Plus)	<ul style="list-style-type: none">Your Maevox device has encountered an error (red device tile).	Keeps all of your device settings, including the IP configuration and password.
Hardware reboot	<ul style="list-style-type: none">Your Maevox device is listed as unresponsive (yellow device tile).PowerStream Plus software is unresponsive, and you can't perform a PowerStream Plus software reboot.	Keeps all of your device settings, including the IP configuration and password.
Configuration reset	<ul style="list-style-type: none">Your Maevox device is still listed as unresponsive (yellow device tile) after a hardware reboot.You're adding a device to a Maevox environment.	Resets all of your device settings, including the IP configuration and password.

Software reboot (PowerStream Plus)

From the PowerStream Plus main interface, click the **Reboot** button to reboot your device.

For more information on PowerStream Plus software, see your PowerStream Plus user guide.

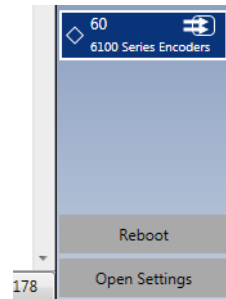

Hardware reboot or configuration reset

Maevex 7112 encoder



- **Hardware reboot** – To reboot your device, press and hold the **Reset** button for approximately *4 seconds* until all LEDs turn off. The LEDs will then turn red, and eventually return to normal operating colors when the boot sequence is complete.
- **Configuration reset** – To reset your device to factory default settings, press and hold the **Reset** button for approximately *14 seconds* until all the LEDs turn off. The LEDs will then turn amber, and eventually return to normal operating colors when the boot sequence is complete.

Maevex 6152 decoder, 6152 encoder, or 6122 encoder



- **Hardware reboot** – Press and hold the **Reset** button on your device with the tip of a paper clip for *less than 2 seconds* (until the LED turns slow blinking green) to reboot your device.
- **Configuration reset** – Press and hold the **Reset** button on your device with the tip of a paper clip for *5 seconds* (until the LED turns fast blinking green) to reboot your device and restore the default settings.

Maevex 6100 PCIe encoder card

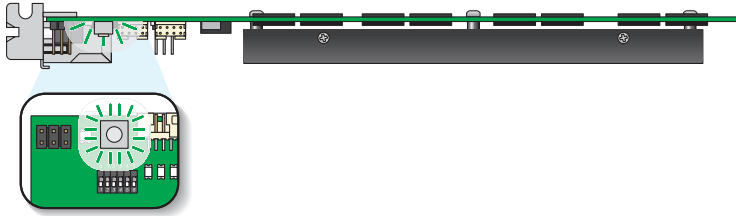

- **Hardware reboot** – Quickly press the button to reboot your device.
- **Configuration reset** – Press and hold the button for *4-5 seconds* (until the LED turns fast blinking green*) to reboot your device and restore the default settings.

Maevex 5150 encoder or 5150 decoder



Maevex 5150 encoder



Maevex 5150 decoder

- **Hardware reboot** – Press and hold the **Reset** button on your device with the tip of a paper clip for *less than 2 seconds* to reboot your device.
- **Configuration reset** – Press and hold the **Reset** button on your device with the tip of a paper clip for *more than 5 seconds* (until the LED turns amber) to reboot your device and restore the default settings.

* **Maevex 6100 encoder only** – If, after performing a configuration reset, the LED turns amber, reboot your encoder by quickly pressing the button on your device.

Installing Matrox PowerStream Plus software



Matrox PowerStream Plus software enables you to remotely control, manage, and configure your MaeveX devices from a controller system in your MaeveX environment.



Note: If you are using a MaeveX 7112A or 7112H encoder, you can connect to it from your web browser by typing the device's IP address in the address bar. For more information, see [“Connecting to MaeveX 7112 devices using a web browser” on page 52.](#)

Before you begin

- You may need administrator rights to install or uninstall certain software. For more information, see Windows documentation or contact your system administrator.
- **Windows Server 2022 and Server 2019** – Make sure the SSDP Discovery service, network discovery, and file sharing options are enabled. For more information, [see page 54.](#)
- Make sure you're using a DHCP server. To assign an initial IP address to your devices, a DHCP (Dynamic Host Configuration Protocol) server is required.

Supported operating systems

Matrox PowerStream Plus software supports the following operating systems:

- Windows® Server® 2022
- Windows® Server® 2019
- Windows® 11 (64-bit)
- Windows® 10 (64-bit)

Software versions and mismatches

- Make sure all of your MaeveX devices are using the latest version of the MaeveX firmware. Also, all MaeveX devices must use the *same version* of the firmware package.
- The version of your firmware package must match the version of your PowerStream Plus software package. If a mismatch is detected, your device won't be detected.

Obtaining Matrox PowerStream Plus software

Matrox makes the latest PowerStream software available on the Matrox web site (<https://video.matrox.com/en/maevexsw>).

Installing your software

To install the software for your Maevox product, run the installation program for your software package. Follow the on-screen instructions.

Accessing Matrox PowerStream Plus software

Windows 11/10 – To access the main interface of PowerStream Plus:

- Windows 11/10 – Click **Start** → **All apps*** → **Matrox PowerStream Plus*** → **Matrox PowerStream Plus**. (* Depending on your configuration of Windows, this part may not be necessary.)

Connecting to Maevox 7112 devices using a web browser

You can access Maevox 7112 devices either through PowerStream Plus or directly with a web browser using the device's IP address. If you don't know the IP address, find it using the Firmware Updater application or through PowerStream Plus. Consult the firmware update guide or the *Matrox PowerStream Plus User Guide* for more details.

To access the Maevox 7112 WebUI in local user mode, you'll need to enter the local username and password. The default settings for a new or factory-reset device are:

- Username: *admin*
- Password: *123456*

PowerStream Plus automatically detects these defaults for ease of use. Remember, when toggling control between PowerStream Plus and the WebUI, you must consistently use these local user credentials.

Additional resources

- **Matrox PowerStream Plus DotNet API** – Find, add, and manage your Matrox Maevox 6100 Series and Maevox 5100 Series devices using the Microsoft® .Net Framework.

- **Maevex 7100 Series Web API** – Interface with your Matrox MaeveX 7100 Series devices using a web service. The MaeveX 7100 Series Web API supports Representational State Transfer (REST) commands. The MaeveX 7100 Series REST API provides methods for accessing every feature in the MaeveX 7100 Series products.
- **Maevex 6100 Series Web API** – Interface with your Matrox MaeveX 6100 Series devices using a web service. The MaeveX 6100 Series Web API supports Representational State Transfer (REST) commands. The MaeveX 6100 Series REST API provides methods for accessing every feature in the MaeveX 6100 Series products.
- **Maevex 5100 Series Web API** – Interface with your Matrox MaeveX 5100 Series devices using a web service. The MaeveX 5100 Series Web API supports Representational State Transfer (REST) commands. The MaeveX 5100 Series REST API provides methods for accessing every feature in the MaeveX 5100 Series products.

To obtain the MaeveX SDK, contact your Matrox representative.

More information

For information on how to use and configure PowerStream Plus software, see the Matrox PowerStream Plus User Guide.

Troubleshooting

What to do if you have a problem

If you experience problems with your Matrox product:

- Make sure your Matrox device is properly installed, you're using the correct connectors, and that all connectors are properly fastened.
- Make sure you have administrator rights on the system you want to use. For more information, see Windows documentation.
- For more information on problems related to Matrox PowerStream Plus software, see the Matrox PowerStream Plus User Guide.

If your problem persists, contact Matrox. For more information, see [“Customer support”](#), page 78.

Common problems and solutions

This section addresses specific problems to your Matrox product that could prevent you from using your system or product.

Problem **Maevex device not discovered on the network**

Cause You may not be using the latest version of Matrox PowerStream Plus software, or your Matrox firmware may be out of date.

Solution For your Maevex devices to be properly detected, make sure all Matrox software is up to date.

Cause Your Matrox product may not be properly installed or connected.

Solution Verify the connection and status LEDs on your Matrox product (see [“Validating your Maevex setup”](#), page 43). Also, make sure your Matrox product is properly installed or connected, and that all connectors are properly fastened.

Cause **Windows Server 2022 and Server 2019 only** – The Windows SSDP Discovery service may be disabled on your system.

Solution Make sure the SSDP Discovery service is enabled on your system.

Cause Network discovery and file sharing may not be enabled on your system.

Solution Enable network discovery and file sharing on your system.

Cause The firewall for your display wall system or for your network may be enabled and may prevent communication with your Maevox devices.

Solution Make sure your firewall is properly configured to allow the necessary communication between your Maevox devices and the various networked components. For more information, see [“Appendix A – Firewall requirements”](#), page 68.

Problem Unable to record to LAN2

Cause A unique IP address may not be specified for the recording location.

Solution Create a unique IP address for the recording location. For more information, contact your network administrator.

Product information

Specifications

Maevox 7112A and 7112H Encoders

	Maevox 7112 encoders
Product type	Standalone appliance
Form factor	1 RU height, 1/3 width
Video output connectors	1x HDMI Type A (with 16-bit stereo L-PCM audio)
Video input connectors	1x HDMI Type A (with 16-bit stereo L-PCM audio)
Audio input connector (line-in)	1x 3.5mm mini-stereo jack (unbalanced)
Networking interface	1x 100/1000 Base-T RJ45 Ethernet Port, auto-speed, half/full duplex, unicast and multicast
USB ports*	1x USB 3.0 (front)
Color conversion	RGB/YUV 4:4:4/4:2:2/4:2:0 8-bit to YUV 4:2:0 8-bit
Audio encoding	AAC-LC Opus and L-PCM (16-bit uncompressed)
Audio sampling frequency	HDMI - 32, 44.1 & 48kHz Analog line in - 48kHz
Video encoding	Maevox 7112A: AVC(H.264) up to High Profile / Level 5.2 Maevox 7112H: AVC(H.264) up to High Profile / Level 5.2, HEVC(H.265) up to Main 12 Profile / Level 5.1 High-Tier
Streaming protocols (single-stream)	RTMP/RTMPS, RTP/RTCP, RTSP over RTP/UDP & TCP, MPEG-2 TS, UDP/RTP, SRT caller and listener
Detection and control protocols	SSDP/UPNP, HTTPS
Supported resolutions (HDMI input/output)†	640x480p60, 720x480p60, 720x576p50, 1280x720p50/60, 1440x900p60, 1680x1050p60, 1600x1200p60, 1920x1080p50/60, 1920x1200p60, 2560x1440p60, 2560x1600p60, 3840x2160p30, 3840x2160p50/60
Rate control	CBR, VBR, low-latency CBR
Maximum encode capabilities	1x UHD (3840 x 2160 @ 60) 4:2:0 8-bit
Recording (destination and format)‡	to NAS, format: HLS(M3U8)
Bit rates	Video: 500 Kbps to 60 Mbps Audio: 64 Kbps to 256 Kbps (1.536 Mbps in the case of uncompressed LPCM audio streaming)

	Maevox 7112 encoders
Power connector [§]	5.5/2.5mm barrel (with screw-type option)
Power consumption	12W
Dimensions	5.50 x 1.25 x 7.21 inches (13.97 x 3.18 x 18.31 cm)
Regulatory compliance	Class A: CE, FCC, ICES-3, KC, RCM, UKCA
Environmental compliance	ROHS, WEEE, REACH

* USB currently not supported (except power over USB).

† When using a video resolution equal to or higher than 1280 × 720p60, we recommend you use certified high-speed HDMI cables. For 4K60 resolution use a certified premium high-speed HDMI cable.

‡ Only supported simultaneously with RTSP streaming.

§ Only use the power supply originally supplied by Matrox with your Matrox Maevox 6152 product.

Maevox 6152 Decoder

	Maevox 6152 decoder
Product type	Standalone appliance
Form factor	1 RU, half width
Video output connectors	4× HDMI Type A (with 16-bit stereo L-PCM audio and HDCP)
Audio output connector (headphone)	1× mini-stereo jack
Audio input connector (microphone)	1× mini-stereo jack
RS232 connector	1× DE9 (also known as DB9) – male
Networking interface	1× 100/1000 Base-T RJ45 Ethernet Port, auto-speed, half/full duplex, unicast and multicast
USB ports	1× USB 2.0 (front), 1× USB 3.0 (back)
Color conversion	YUV 4:0:0, 4:2:0, 4:2:2, or 4:4:4 to RGB 4:4:4 8-bit
Audio decoding (max. bitrate)	AAC-LC (576 kbps), HEV1 (288 kbps), HEV2 (144 kbps)
Streaming protocols	RTP, RTSP, MPEG-2 TS, SRT
Command protocols	UPnP, HTTPS
Maximum output resolutions*	4096 × 2160 @ 60 Hz, or 3840 × 2160 @ 60 Hz
Maximum decode capabilities†	4× 3840 × 2160 @ 30 Hz, 3× 4096 × 2160 @ 30 Hz, 2× 3840 × 2160 @ 60 Hz, 8× 1920 × 1080 @ 60 Hz, 16× 1920 × 1080 @ 30 Hz
Maximum bit rate (per video stream)	120 Mbps

	Maevex 6152 decoder
Power connector†	DIN 4-pin female (locking)
Power consumption	48W§ (Typical: 27W)¶
Dimensions	21.7 cm × 18.9 cm × 4.3 cm / 8.53 inches × 7.45 inches × 1.68 inches
Regulatory compliance	Class A: CE, FCC, ICES-3, KC, RCM, UKCA
Environmental compliance	ROHS, WEEE, REACH

* When using a display resolution equal to or higher than 1280 × 720p60, we recommend you use certified high-speed HDMI cables. For 4K60 resolution use a certified premium high-speed HDMI cable.

† In 4:2:0 only.

‡ Only use the power supply originally supplied by Matrox with your Matrox Maevex 6152 product.

§ Including power drawn by peripheral devices (10W total over two USB connectors).

¶ Typical: Measured cfg is 4 × 1920 × 1080p60, 15 Mb/s decoding.

Maevex 6152 Encoder

	Maevex 6152 encoder
Product type	Standalone appliance
Form factor	1 RU, half width
System memory	4 GB
Video input connectors	4 × HDMI Type A (with 16-bit stereo L-PCM audio and HDCP)
Video output connectors	4 × HDMI Type A (with 16-bit stereo L-PCM audio and HDCP), and 1 × DisplayPort (for console display)
Audio input connector (analog)	4 × mini-stereo jacks
Audio output connector (headphone)	1 × mini-stereo jack
Microphone input connector	1 × mini-stereo jack
RS232 connector	1 × DE9 (also known as DB9) – male
Networking interface	2 × 100/1000 Base-T RJ45 Ethernet Port, auto-speed, half/full duplex, unicast, multicast, and multi-unicast (1 × control and stream, and 1 × secondary stream)
USB ports	2 × USB 2.0 (front), 1 × USB 3.0 (back)
Color sampling and conversion	4:2:0, 4:0:0 (8-bit and 10-bit) 4:4:4, 4:2:2 (8-bit)
Audio encoding (max. bitrate)	AAC-LC (576 kbps), HEV1 (288 kbps), HEV2 (144 kbps)
Video encoding	H.264/MPEG-4 Part 10 (AVC), Up to level 5.2, Baseline profile (BP), Main profile (MP), High profile (HiP), High 10 profile (Hi10P), High 4:2:2 profile (Hi422P), High 4:4:4 predictive profile separate plane (Hi444PP), CAVLC 4:4:4 Intra (44)

	Maevex 6152 encoder
Streaming protocols	RTP, RTSP, RTMP, MPEG-2 TS, SRT, HLS
Command protocols	UPnP, HTTPS
Supported resolutions (HDMI video input and output)*†	4096 × 2160p24/25/30/50/60, 3840 × 2160p24/25/30/50/60§, 2560 × 1600, 2560 × 1440, 1920 × 1200p56/60, 1920 × 1080i50/60, 1920 × 1080p30/50/60, 1680 × 1050, 1600 × 1200, 1440 × 900, 1400 × 1050, 1280 × 1024, 1280 × 720p50/60, 1024 × 768, 800 × 600, 720 × 576, 720 × 480, and 640 × 480
Supported resolutions (DisplayPort video output for console display)	Up to 1920 × 1080 @ 60 Hz
Multi-encode/ Multi-stream/ Record‡	2× 3840 × 2160 @ 60 Hz, 4× 3840 × 2160 @ 30 Hz, 8× 1920 × 1080 @ 60 Hz, 16× 1280 × 720 @ 60 Hz, or numerous SD IP channels
Maximum bit rate (per video stream)	120 Mbps
Maximum combined bit rates (all video streams and recordings)§	800 Mbps
Rate control	Constant bit rate (CBR), Variable bit rate (VBR), Constrained VBR, Configurable group of pictures (GOP)
Recording file format	MP4, fMP4, MOV
Recording location	NAS device, external USB storage device
Power connector¶	DIN 4-pin female (locking)
Power consumption	6152: 60W** (Typical: 36W)††
Dimensions	21.7 cm × 18.9 cm × 4.3 cm / 8.53 inches × 7.45 inches × 1.68 inches
Regulatory compliance	Class A: CE, FCC, ICES-3, KC, RCM, UKCA
Environmental compliance	ROHS, WEEE, REACH

* When using a display resolution equal to or higher than 1280 × 720p60, we recommend you use certified high-speed HDMI cables. For 4K60 resolution, use a certified premium high-speed HDMI cable.

† Unless otherwise specified, modes are p60 (progressive 60 Hz).

‡ Color sampling and color depth limitations may apply. For more information, see "Notes and limitations", page 66.

§ Depending on network speed and conditions.

¶ Only use the power supply originally supplied by Matrox with your Matrox Maevex 6152 product.

** Including power drawn by peripheral devices (10W total over three USB connectors).

†† Typical: Measured cfg is 4× 1920 × 1080p60, 15 Mb/s streaming and recording.

Maevex 6122 Encoder

	Maevex 6122 encoder
Product type	Standalone appliance
Form factor	1 RU, half width
System memory	4 GB
Video input connectors	2× HDMI Type A (with 16-bit stereo L-PCM audio and HDCP)
Video output connectors	2× HDMI Type A (with 16-bit stereo L-PCM audio and HDCP), and 1× DisplayPort (for console display)
Audio input connector (analog)	2× mini-stereo jacks
Audio output connector (headphone)	1× mini-stereo jack
Microphone input connector	1× mini-stereo jack
RS232 connector	1× DE9 (also known as DB9) – male
Networking interface	2× 100/1000 Base-T RJ45 Ethernet Port, auto-speed, half/full duplex, unicast, multicast, and multi-unicast (1× control and stream, and 1× secondary stream)
USB ports	2× USB 2.0 (front), 1× USB 3.0 (back)
Color sampling and conversion	4:2:0, 4:0:0 (8-bit and 10-bit) 4:4:4, 4:2:2 (8-bit)
Audio encoding (max. bitrate)	AAC-LC (576 kbps), HEV1 (288 kbps), HEV2 (144 kbps)
Video encoding	H.264/MPEG-4 Part 10 (AVC), Up to level 5.2, Baseline profile (BP), Main profile (MP), High profile (HiP), High 10 profile (Hi10P), High 4:2:2 profile (Hi422P), High 4:4:4 predictive profile separate plane (Hi444PP), CAVLC 4:4:4 Intra (44)
Streaming protocols	RTP, RTSP, RTMP, MPEG-2 TS, SRT, HLS
Command protocols	UPnP, HTTPS
Supported resolutions (HDMI video input and output)*†	4096 × 2160p24/25/30/50‡/60§, 3840 × 2160p24/25/30/50§/60§, 2560 × 1600, 2560 × 1440, 1920 × 1200p56/60, 1920 × 1080i50/60, 1920 × 1080p30/50/60, 1680 × 1050, 1600 × 1200, 1440 × 900, 1400 × 1050, 1280 × 1024, 1280 × 720p50/60, 1024 × 768, 800 × 600, 720 × 576, 720 × 480, and 640 × 480
Supported resolutions (DisplayPort video output for console display)	Up to 1920 × 1080 @ 60 Hz
Multi-encode/ Multi-stream/ Record§	2× 3840 × 2160 @ 60 Hz, 4× 3840 × 2160 @ 30 Hz, 8× 1920 × 1080 @ 60 Hz, 16× 1280 × 720 @ 60 Hz, or numerous SD IP channels

	Maevox 6122 encoder
Maximum bit rate (per video stream)	120 Mbps
Maximum combined bit rates (all video streams and recordings)[¶]	800 Mbps
Rate control	Constant bit rate (CBR), Variable bit rate (VBR), Constrained VBR, Configurable group of pictures (GOP)
Recording file format	MP4, fMP4, MOV
Recording location	NAS device, external USB storage device
Power connector^{**}	DIN 4-pin female (locking)
Power consumption	6122: 45W ^{††} (Typical: 27W) ^{‡‡}
Dimensions	21.7 cm × 18.9 cm × 4.3 cm / 8.53 inches × 7.45 inches × 1.68 inches
Regulatory compliance	Class A: CE, FCC, ICES-3, KC, RCM, UKCA
Environmental compliance	ROHS, WEEE, REACH

* When using a display resolution equal to or higher than 1280×720p60, we recommend you use certified high-speed HDMI cables. For 4K60 resolution, use a certified premium high-speed HDMI cable.

† Unless otherwise specified, modes are p60 (progressive 60 Hz).

‡ In 4:2:0 only for the 6122 encoder.

§ Color sampling and color depth limitations may apply. For more information, see "Notes and limitations", page 66.

¶ Depending on network speed and conditions.

** Only use the power supply originally supplied by Matrox with your Matrox Maevox 6122 product.

†† Including power drawn by peripheral devices (10W total over three USB connectors).

‡‡ Typical: Measured cfg is 2× 1920 × 1080p60, 15 Mb/s streaming and recording.

Maevox 6100 Encoder

	Maevox 6100 encoder
Product type	PCIe ×16 card (power only)
Form factor	Full height
Memory	4 GB
Input connectors	4× Mini HDMI Type C (with 16-bit digital L-PCM audio (stereo))
Networking interface	1× 100/1000 Base-T RJ45 Ethernet Port, auto-speed, half/full duplex, unicast, multicast, and multi-unicast
Color sampling and conversion	4:2:0, 4:0:0 (8-bit and 10-bit) 4:4:4, 4:2:2 (8-bit)
Audio encoding (Maximum bit rate)	AAC-LC (576 kbps), HEV1 (288 kbps), HEV2 (144 kbps)

	Maevox 6100 encoder
Video encoding	H.264/MPEG-4 Part 10 (AVC), Up to level 5.2, Baseline profile (BP), Main profile (MP), High profile (HiP), High 10 profile (Hi10P), High 4:2:2 profile (Hi422P), High 4:4:4 predictive profile separate plane (Hi444PP), CAVLC 4:4:4 Intra (44)
Streaming protocols	RTP, RTSP, RTMP, MPEG-2 TS, SRT, HLS, fMP4
Command protocols	UPnP, HTTPS
Supported resolutions**	4096 × 2160p24/25/30/50†/60‡, 3840 × 2160p24/25/30/50§/60‡, 2560 × 1600, 2560 × 1440, 1920 × 1200p56/60, 1920 × 1080i50/60, 1920 × 1080p30/50/60, 1680 × 1050, 1600 × 1200, 1440 × 900, 1400 × 1050, 1280 × 1024, 1280 × 720p50/60, 1024 × 768, 800 × 600, 720 × 576, 720 × 480, and 640 × 480
Multi-encode/ Multi-stream/ Record§	2× 3840 × 2160 @ 60 Hz, 4× 3840 × 2160 @ 30 Hz, 8× 1920 × 1080 @ 60 Hz, 16× 1280 × 720 @ 60 Hz, or numerous SD IP channels
Maximum bit rate (per stream)	120 Mbps
Maximum combined bit rates (all streams and recordings)¶	800 Mbps
Rate control	Constant bit rate (CBR), Variable bit rate (VBR), Constrained VBR, Configurable group of pictures (GOP)
Recording file format	MP4, MOV
Recording location	NAS device
Power consumption	25W (12V), 6W (3.3V) Total: 31W
Maximum card dimensions	22.9 cm × 1.91 cm × 11.1 cm / 9.02 inches × 0.75 inches × 4.376 inches
Regulatory compliance	Class B: CE, FCC, ICES-3, KC, RCM, UKCA
Environmental compliance	ROHS, WEEE, REACH

* When using a display resolution equal to or higher than 1280 × 720p60, we recommend you use certified high-speed HDMI cables.

† Unless otherwise specified, modes are p60 (progressive 60 Hz).

‡ In 4:2:0 only.

§ Color sampling and color depth limitations may apply. For more information, see "Notes and limitations", page 66.

¶ Depending on network speed and conditions.

Maevox 5150 Encoder

	Maevox 5150 encoder
Product type	Standalone appliance
Video input connector	1× HDMI

	Maevox 5150 encoder
Video output connectors	1× HD-15 (VGA) + 1× HDMI
Audio input connector	1× mini-stereo jack
Audio output connector	1× mini-stereo jack
Network connector	1× RJ45
RS232 connector	1× DE9 (also known as DB9) – female
Video stream output	MPEG-4 Part 10 / AVC (H.264)
Audio stream support	MPEG4-GENERIC (firmware version newer than 1.03.03), MPEG4-LATM (up to firmware version 1.03.03)
Streaming protocols	RTP, RTSP, RTCP, UDP
Command protocols	TCP/IP, UPnP, HTTPS
Supported resolutions (input)*†‡	1920 × 1200, 1920 × 1080, 1680 × 1050, 1600 × 1200, 1600 × 900, 1440 × 900, 1400 × 1050, 1360 × 768, 1280 × 1024, 1280 × 960, 1280 × 720, 1024 × 768, 800 × 600, 720 × 576, 720 × 480, and 640 × 480
Supported resolutions (output)	1920 × 1200, 1920 × 1080, 1680 × 1050, 1600 × 1200, 1600 × 900, 1440 × 900, 1400 × 1050, 1366 × 768, 1360 × 768, 1280 × 1024, 1280 × 960, 1280 × 768, 1280 × 720, 1024 × 768, 852 × 480, 848 × 480, 800 × 600, 720 × 576, 720 × 480, and 640 × 480
Additional supported HDMI resolutions†	1080p50, 1080p30, 1080i60/50§, 720p50, and 576p50
Maximum unicast connections¶	8
Power connector	DIN 4-pin female
Power consumption	9W** (Minimum: 6W)
Dimensions	21.59 cm × 2.59 cm × 10.16 cm / 8.50 inches × 1.02 inches × 4.00 inches
Regulatory compliance	Class B: CE, FCC, ICES-3, KC, RCM, UKCA, VCCI
Environmental compliance	ROHS, WEEE, REACH

* All supported resolutions have a vertical refresh rate of 60 Hz.

† When using a display resolution equal to or higher than 1280×720p60, we recommend you use certified high-speed HDMI cables.

‡ When pass through is enabled, only the resolutions supported by your monitor may be available.

§ Interlaced resolutions are only supported at input. When using interlaced resolutions, the capture rate selection is disabled and your encoder automatically captures all frames.

¶ With a resolution of 1080p at 15Mb/s.

** With a stream of 1080p60 at 25Mb/s.

Maevex 5150 Decoder

	Maevex 5150 decoder
Product type	Standalone appliance
Video output connectors	1× HDMI
Audio output connector	1× mini-stereo jack
Network connectors	2× RJ45
RS232 connector	1× DE9 (also known as DB9) – female
Video stream support	MPEG-4 Part 10 / AVC (H.264)
Audio stream support	MPEG4-GENERIC (firmware version newer than 1.03.03), MPEG4-LATM
Streaming protocols	RTP, RTSP, RTCP, UDP
Command protocols	TCP/IP, UPnP, HTTP
Supported resolutions (output)**	1920 × 1200, 1920 × 1080, 1680 × 1050, 1600 × 1200, 1600 × 900, 1440 × 900, 1400 × 1050, 1366 × 768, 1360 × 768, 1280 × 1024, 1280 × 960, 1280 × 768, 1280 × 720, 1024 × 768, 852 × 480, 848 × 480, 800 × 600, 720 × 576, 720 × 480, and 640 × 480
Additional supported HDMI resolutions†	1080p50, 1080p30, 720p50, and 576p50
Power connector	DIN 4-pin female
Power consumption	6W‡ (Minimum: 4.5W)
Dimensions	12.83 cm × 2.59 cm × 10.90 cm / 5.05 inches × 1.02 inches × 4.29 inches
Regulatory compliance	Class B: CE, FCC, ICES-3, KC, RCM, UKCA, VCCI
Environmental compliance	ROHS, WEEE, REACH

* All supported resolutions have a vertical refresh rate of 60 Hz.

† When using a display resolution equal to or higher than 1280 × 720p60, we recommend you use certified high-speed HDMI cables.

‡ With a stream of 1080p60 at 25Mb/s.

Analog audio

	6152 decoder	6152 encoder	6122 encoder
Headphone connector	Full-scale output voltage: 1.2 Vrms (1.6 dBV) Driver strength: 32 mW into 32 Ohms Gain: -74 dB to 0 dB (default is 0 dB)		

External power supply

	7112 encoder	6152 decoder	6152 encoder	6122 encoder	5150 encoder	5150 decoder
Input a.c. voltage range	100V to 240V a.c.					
Input frequency	50 to 60 Hz					
Input connector	IEC 60320-C6	IEC 60320-C14			IEC 60320-C8	
Output voltage	12V d.c.			5V d.c.		
Output current	3.33A	5A			3A	
Output connector	5.5 x 2.5mm barrel plug (screw-in type)	DIN 4-pin male (with lock)			DIN 4-pin male (with lock)	
Output power	40W	60W			15W	
Average active efficiency @ 230V a.c., 50 Hz	88.98%	89.3%			81.8%	
Efficiency at low load (10%) @ 230V a.c., 50 Hz	85.07%	85.7%			80.2%	
No-load power consumption @ 230V a.c., 50 Hz	0.0548W	0.12W			0.08W	

Environmental

Temperature, operational	0 to 45 °C (32 to 113 °F)
Temperature, non-operational storage and transportation	-40 to 70 °C (-40 to 158 °F)
Humidity, operational (indoor)	20% to 80% (non-condensing)
Humidity, non-operational storage and transportation	5% to 95% (non-condensing)
Atmospheric pressure, operational	600hPa (3,000 meters / 9,842 feet) to 1013hPa (0 meters / 0 feet)
Atmospheric pressure, non-operational and transportation	192hPa (12,000 meters / 39,370 feet) to 1020hPa (-50 meters / -164 feet)

Supported standards

	7112 encoder	6152 decoder	6152 encoder	6122 encoder	6100 encoder	5150 encoder/decoder
HDMI	✓	✓	✓	✓	✓	✓
DVI 1.0 compatible (using HDMI to DVI-D adapter)	✓	✓	✓	✓	✓	✓
EDID (Extended Display Identification Data) 1.3 and VESA E-EDID Standard Release A, Revision 1	✓	✓	✓	✓	✓	✓
USB 2.0 compatible	✓	✓	✓	✓	—	—
USB 3.0 compatible	✓	✓	✓	✓	—	—
VESA DisplayPort Standard, version 1.1	—	—	✓	✓	—	—

Notes and limitations

The Maevox 6150 and 6120 devices have been superseded by the Maevox 6152 and 6122 devices respectively. However, the Maevox 6150 and 6120 devices are forward compatible and are supported by the latest PowerStream Plus software and Maevox firmware.

Maevox 7112 encoders

- Only one unicast or multicast stream is supported at any given time.
- Multi-stream encoding and simultaneous multi-protocol streaming are not supported (single-channel / single-stream encoder).
- Capture, encoding, and streaming of interlaced content and HDCP (protected) content are not supported.
- Maevox 7112A only supports AVC(H.264) video encoding (by product definition).

Maevox 6152 and 6122 encoders

- Certain limitations may occur when using scaling, multi-input compositing, or the DisplayPort console output. For more information, contact Matrox technical support.
- While using HDMI input or DisplayPort output resolutions higher than 1920 × 1080, the frame rate of the DisplayPort console display (if enabled) will be reduced to 30 fps or 15 fps to preserve computing power. The frame rate of the DisplayPort console display won't match the captured and encoded frame rate.

Maevox 6100 encoders

- 10-bit capture is supported only while using source resolutions up to 1920 × 1200p60.
- While using a resolution of 3840 × 2160 at 60 Hz or 4096 × 2160 at 60 Hz, capture and encoding are supported only in 4:2:0.

Maevox 6152 and 6122 encoders

- A Maevox 6152 or 6122 encoder with protected content support disabled will not capture and process any protected content from any source.
- If protected content support is enabled, all outgoing streams will be protected, and only RTSP or RTP protocols will be allowed. Only a Maevox 6152 decoder with protected content support enabled will be able to decode these protected streams. Also, the DisplayPort console output as well as the recording function will be inaccessible (on protected encoder devices).

Maevox 6152 decoder

- Interlaced output modes are not supported.
- At 3840 x 2160p60 and 4096 x 2160p60 resolutions, the YUV 4:4:4 pixel format is only supported through HDMI Outputs 1 and 3 with HDMI Outputs 2 and 4 remaining unused in this case. For more details, refer to the PowerStream Plus User Guide.
- If a Maevox 6152 decoder is configured with four (4) times the same output resolution, for example, 1920 x 1080 or 3840 x 2160, and the failsafe feature is used, it is recommended to select a failsafe video file that has the same resolution as the outputs, that is, 1920 x 1080 or 3840 x 2160. In the case of a resolution mismatch, scaling will occur, and depending on the output configuration, the failsafe content may have dropped frames or reduced frame rate. Alternatively, a still image can be used as a failsafe content.
- A Maevox 6152 decoder with the protected content support enabled will also decode non-protected content from a Maevox 6100 Series encoder with protected content turned off, or from any other third-party encoder source. Such a decoder will only provide HDMI signal and content to HDCP-capable devices, regardless of the protected or non-protected nature of the decoded streams.

Appendix A – Firewall requirements

The following are the firewall requirements for your controller system and for a network with a Maevox environment.

PowerStream Plus software

The following are the firewall requirements for your controller system.

Network Port	Type	Inbound	Outbound	Functionality
20,21	TCP	—	✓	FTP: Failsafe file upload*
53	TCP	—	✓	DNS: DNS requests
443, 8843†	TCP	—	✓	HTTPS: PowerStream Plus / REST API commands
1900, 1910†	UDP	✓	✓	UPnP: Microsoft SSDP for discovery of UPnP devices Note: ICMP must be enabled (ping).

* Maevox 5150 decoder only.

† Minimum requirements.

Firmware updater

The following are the firewall requirements for a system running the Matrox Firmware Updater.

Network Port	Type	Inbound	Outbound	Functionality
20,21	TCP	—	✓	FTP: Firmware file transfer to devices
22*	TCP	✓	✓	SSH: Firmware update commands
443, 8843 (for Maevox 7112)†	TCP	—	✓	HTTPS: Authentication and firmware update commands
1900, 1901 (for Maevox 7112), 1910*	UDP	✓	✓	UPnP: Microsoft SSDP for discovery of UPnP devices

* Minimum requirements.

Maevox devices

The following are the requirements for a network firewall present on a network with a Maevox environment.

Network Port	Type	Inbound	Outbound	Functionality
20,21	TCP	✓	—	FTP: File download (failsafe or firmware)
22*	TCP	✓	✓	SSH: Firmware update commands
69	UDP	—	✓	DHCP: DHCP client
123	UDP	✓	✓	NTP: Network Time Protocol
161	UDP	✓	✓	SNMP: Network management (public community string)
443, 8443 (for Maevox 7112)*	TCP	✓	—	HTTPS: PowerStream Plus commands, authentication, and firmware updaters commands / REST API
1500	UDP	—	✓	MPEG-2 TS: Streaming (configurable)
1500	UDP	✓	✓	SRT: Streaming (configurable)
1900*	UDP	✓	✓	UPnP: Microsoft SSDP for discovery of UPnP devices
Ephemeral*	UDP	✓	✓	RTP/RTCP: Audio and video streams and control
1935	TCP	—	✓	RTMP: Streaming (configurable)
8554 (Maevox 5150), 3049 (Maevox 6100)*	TCP	✓	✓	RTSP: Streaming (configurable)
12000†	TCP	✓	✓	RS232: RS232 virtualization

* Minimum requirements.

† Fixed value when using the **Relayed serial over IP** feature in PowerStream Plus. User defined when using the **Direct serial over IP** feature in PowerStream Plus.

Accessing your Windows Firewall settings



Note: You may need administrator rights to modify your Windows Firewall settings. For more information, see Windows documentation or contact your system administrator.

To access your Windows Firewall settings:

Windows 11/10 –

- 1 Click **Start** → **Settings** → **Network & Internet** → **Ethernet** → **Windows Firewall**.
- 2 In the left panel, click **Advanced Settings**.

Adding rules to your Windows Firewall settings



Note: You may need administrator rights to modify your Windows Firewall settings. For more information, see Windows documentation or contact your system administrator.

Windows 11/10 –

- 1 Click **Start** → **Settings** → **Network & Internet** → **Ethernet** → **Windows Firewall**.
- 2 In the left panel, click **Advanced Settings**.
- 3 Click **Inbound Rules**.
- 4 In the **Actions** panel, click **New Rule**. Configure the new rule with the following settings:
 - **Rule** – Select **Custom**.
 - **Program** – Select **All programs**.
 - **Protocol and Ports** – Next to **Protocol**, select **TCP**. Next to **Local port**, select **Specific ports**. For the port number, enter **445**. Next to **Remote port**, select **All Ports**.
 - **Scope** – Under the remote IP address, add the IP range you want to use for your encoders. You can use a range (such as *192.168.1.0/24*) or a single IP address (such as *192.152.168.62*).
 - **Action** – Select **Allow the connection**.
 - **Profile** – Select the network location of your system (**Domain**, **Private**, or **Public**).
 - **Name** – Enter the name for your rule (such as *Maevex Encoder Recording – TCP rule*).
- 5 In the **Actions** panel, click **New Rule**. Configure the new rule with the following settings:
 - **Rule type** – Select **Custom**.
 - **Program** – Select **All programs**.

- **Protocol and Ports** – Under **Protocol type**, select **ICMPv4**.
- **Scope** – Under the remote IP address, add the IP range you want to use for your encoders. You can use a range (such as *192.168.1.0/24*) or a single IP address (such as *192.152.168.62*).
- **Action** – Select **Allow the connection**.
- **Profile** – Select the network location of your system (**Domain**, **Private**, or **Public**).
- **Name** – Enter the name for your rule (such as *Maevex Encoder Recording – ICMPv4 rule*).

For more information on configuring your Windows firewall, see your network administrator.

Appendix B – Providing adequate airflow to your Maevox device

Maevox 7112A and 7112E Encoders, Maevox 6152 Decoder, Maevox 6152 Encoder, Maevox 6122 Encoder, Maevox 5150 Encoder, and Maevox 5150 Decoder – Because your device disperses heat, it requires adequate airflow to ensure proper operation and to prevent damage. The following provides guidelines for effective airflow around your device.

- **Leave the proper amount of room around your device** – To prevent airflow restriction, we recommend allowing *at least* 0.75 inches (1.91 cm) of clearance between the top of your device and anything above it. More space may be required depending on your environment.

When your device is resting on a plain surface, make sure your device is resting on the original rubber feet. If your device is being rack mounted, remove the rubber feet.

- **Operate your device in a well ventilated location** – Don't operate your device near a heat source or restrict airflow to your device (for example, by operating your device inside a desk cabinet).
- **Monitor your ambient temperatures** – Make sure the ambient temperature doesn't exceed the maximum recommended temperatures.

For more information on supported operating temperatures, see [“Environmental”](#), page 65.

Appendix C – Installing your Matrox secure cable solution for cards

1

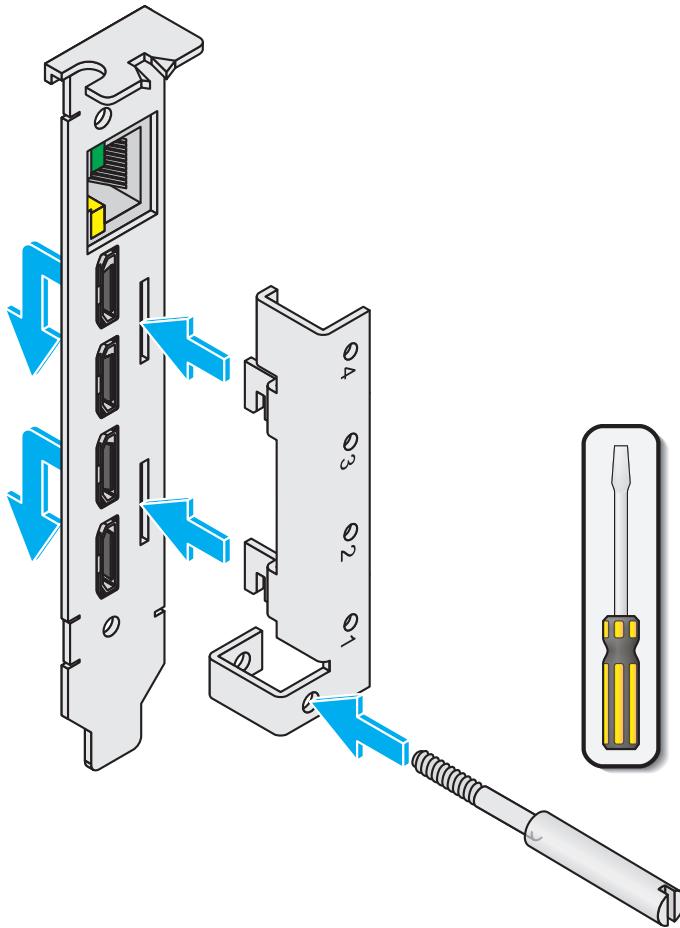

2

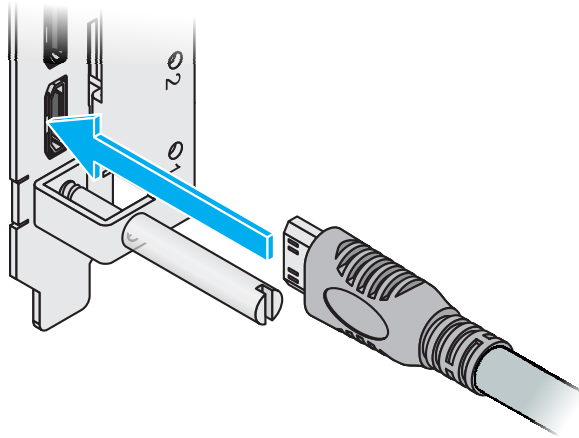

3

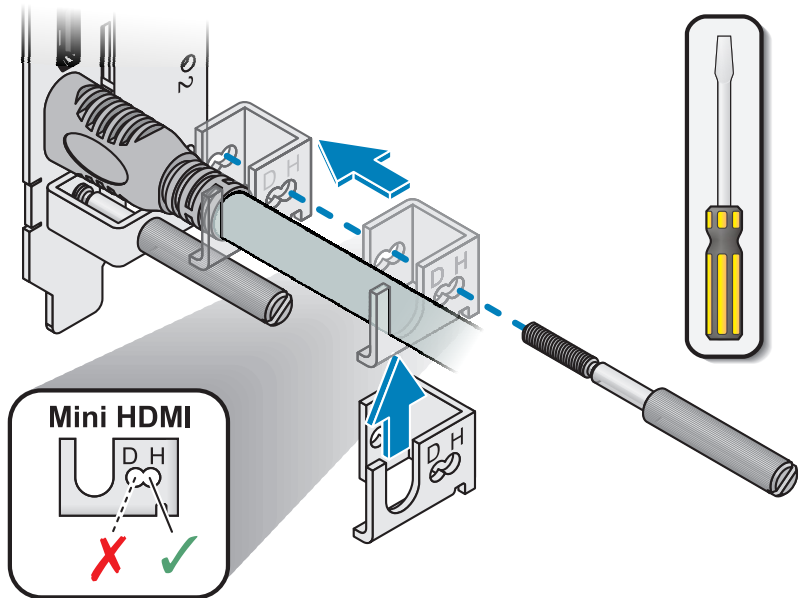

Appendix D – Installing your Matrox secure cable solution for appliances

HDMI

1

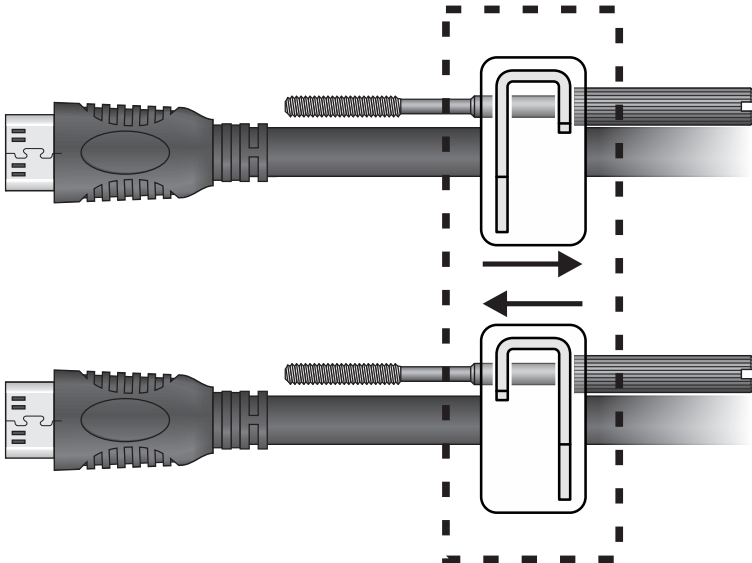
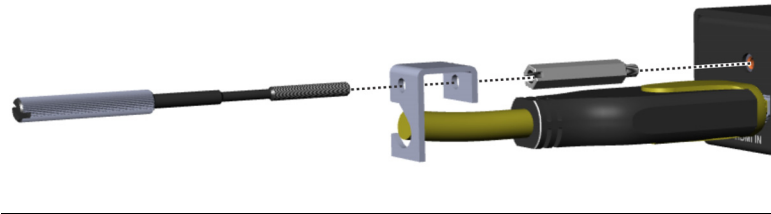
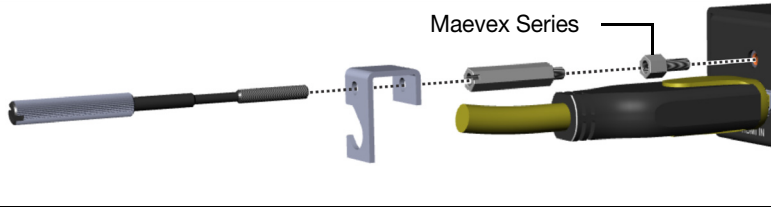

2

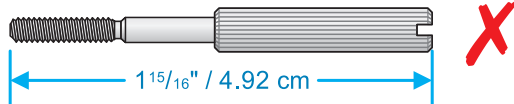
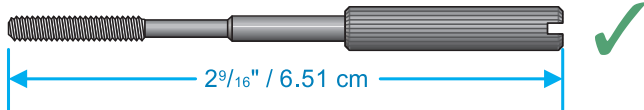
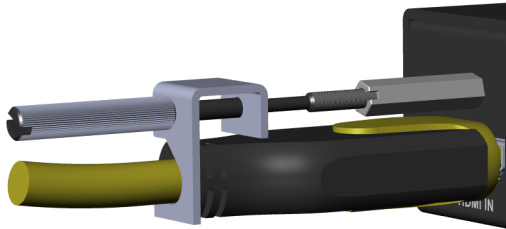
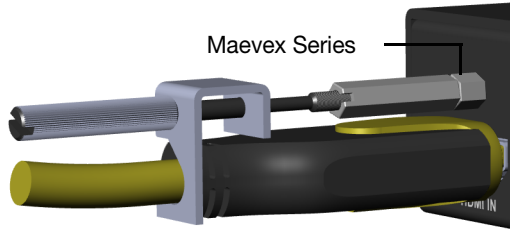

Customer support

Matrox Web

Our web site has product literature, press releases, technical material, a sales office list, trade show information, and other relevant material. Visit the Matrox Graphics web site at <https://video.matrox.com>.

Technical support

Matrox values your business and offers professional support for your Matrox product.

If your product was purchased through a Matrox dealer, contact your dealer for product support. This is the quickest and most effective method of technical assistance. Your dealer is familiar with your complete system.

If your product was purchased through Matrox, contact your Matrox representative or visit our technical support web site at <https://video.matrox.com/en/support>.

Information we need

Please give a complete description of the problem, and include:

- Matrox product serial number, model number, revision number, and firmware number.
- Computer brand and model name.
- Graphics card manufacturer, model number, revision number, BIOS number, driver type and version.
- Monitors brand and model name.
- Operating system, version, and service pack.

Firmware package

A more recent firmware package may support more features and may offer increased capabilities. To obtain the latest firmware package, see the Matrox web site (<https://video.matrox.com/maevexsw>).

View your warranty information

Matrox makes warranty information available on the Matrox site (<https://video.matrox.com/en/support/warranty>).

View the third party software notices

Matrox makes third party software notices and/or additional terms and conditions available on the Matrox site (<https://thirdpartylicenses.matrox.com>).

Register your Matrox product

Please register online (<https://video.matrox.com/en/apps/registration>) to be eligible for customer support, new product announcements, and information on special offers and upcoming events.

Hot surface Allow hot surfaces to cool before touching your Matrox unit.

Surface chaude Laissez refroidir les surfaces chaudes avant de toucher votre appareil Matrox.

Battery replacement The battery is non replaceable. To dispose of your product, see www.matrox.com/environment/weee.



Remplacement des piles La pile n'est pas remplaçable. Pour se défaire du produit, voir www.matrox.com/environment/weee.

USA

FCC Compliance Statement

Remark for the Matrox hardware products supported by this guide This equipment has been tested and found to comply with the limits for a Class A digital device, pursuant to Part 15 of the FCC Rules. These limits are designed to provide reasonable protection against harmful interference when the equipment is operated in a commercial environment. This equipment generates, uses, and can radiate radio frequency energy and, if not installed and used in accordance with the instructions manual, may cause harmful interference to radio communications. Operation of this equipment in a residential area is likely to cause harmful interference in which case the user will be required to correct the interference at his own expense.

WARNING Changes or modifications to this unit not expressly approved by the party responsible for the compliance could void the user's authority to operate this equipment. The use of shielded cables for connection of the monitor to the card is required to meet FCC requirements.

CANADA

(English) Innovation, Science and Economic Development Canada

Remark for the Matrox hardware products supported by this guide These digital apparatus does not exceed the Class A limits for radio noise emission from digital devices set out in the Radio Interference Regulation of Innovation, Science and Economic Development Canada.

(Français) Innovation, Sciences et Développement économique Canada

Remarque sur les produits matériels Matrox couverts par ce guide Ce présent appareil numérique n'émet aucun bruit radioélectrique dépassant les limites applicables aux appareils numériques de Classe A prescrites dans le Règlement sur le brouillage radioélectrique édicté par Innovation, Sciences et Développement économique Canada.

UNITED KINGDOM

United Kingdom user's information – Declaration of Conformity

Remark for the Matrox hardware products supported by this guide These devices comply with Directive UK SI 2016 No. 1091 relating to electromagnetic compatibility for a Class A digital device. They have been tested and found to comply with EN55032/CISPR32 and EN55035/CISPR35. In a domestic environment these products may cause radio interference in which case the user may be required to take adequate measures. To meet UK requirements, shielded cables must be used to connect the monitor and other peripherals to the card. These products have been tested in a typical class A compliant host system. It is assumed that these products will also achieve compliance in any class A compliant system.

JAPAN

VCCI Compliance Statement

Remark for the Matrox hardware products supported by this guide This is a Class A product based on the standard of the Voluntary Control Council for Interference by Information Technology Equipment (VCCI). If this

equipment is used in a domestic environment, radio disturbance may occur, in which case, the user may be required to take corrective actions.

この装置は、クラスA情報技術装置です。この装置を家庭環境で使用すると電波妨害を引き起こすことがあります。この場合には使用者が適切な対策を講ずるよう要求されることがあります。 VCCI-A

KOREA

A 급 기기 (업무용 방송통신기자재)

이 기기는 업무용 (A 급) 전자파적합기기로서 판매자 또는 사용자는 이 점을 주의하시기 바라며, 가정외의 지역에서 사용하는 것을 목적으로 합니다.

EUROPE

(English) European user's information – Declaration of Conformity



Remark for the Matrox hardware products supported by this guide These devices comply with EC Directive 2014/30/EU for a Class A digital device. They have been tested and found to comply with EN55032/CISPR32 and EN55035/CISPR35. In a domestic environment these products may cause radio interference in which case the user may be required to take adequate measures. To meet EC requirements, shielded cables must be used to connect the monitor and other peripherals to the card. These products have been tested in a typical class A compliant host system. It is assumed that these products will also achieve compliance in any class A compliant system.

(Français) Informations aux utilisateurs Européens – Déclaration de conformité

Remarque sur les produits matériels Matrox couverts par ce guide Ces unités sont conformes à la directive communautaire 2014/30/EU pour les unités numériques de classe A. Les tests effectués ont prouvé qu'elles sont conformes aux normes EN55032/CISPR32 et EN55035/CISPR35. Le fonctionnement de ces produits dans un environnement résidentiel peut causer des interférences radio, dans ce cas l'utilisateur peut être amené à prendre les mesures appropriées. Pour respecter les impératifs communautaires, les câbles de connexion entre le moniteur ou autres périphériques et la carte doivent être blindés. Ces produits ont été testés dans un système hôte typique compatible classe A. On suppose qu'ils présenteront la même compatibilité dans tout système compatible classe A.

(Deutsch) Information für europäische Anwender – Konformitätserklärung

Anmerkung für die Matrox Hardware-Produktunterstützung durch dieses Handbuch Diese Geräte entsprechen EC Direktive 2014/30/EU für ein digitales Gerät Klasse A. Sie wurden getestet und entsprechen demnach EN55032/CISPR32 und EN55035/CISPR35. In einer Wohnumgebung können diese Produkte Funkinterferenzen erzeugen, und der Benutzer kann genötigt sein, entsprechende Maßnahmen zu ergreifen. Um EG-Anforderungen zu entsprechen, müssen zum Anschließen des Monitors und anderer Peripheriegeräte an die Karte abgeschirmte Kabel verwendet werden. Diese Produkt werden in einem typischen, der Klasse A entsprechenden, Host-System getestet. Es wird davon ausgegangen, daß diese Produkte auch in jedem Klasse A entsprechenden System entsprechend funktionieren.

(Italiano) Informazioni per gli utenti europei – Dichiarazione di conformità

Nota per i prodotti hardware Matrox supportati da questa guida Questi dispositivi sono conformi alla direttiva CEE 2014/30/EU relativamente ai dispositivi digitali di Classe A. Sono stati provati e sono risultati conformi alle norme EN55032/CISPR32 e EN55035/CISPR35. In un ambiente domestico, questi prodotti possono causare radiointerferenze, nel qual caso all'utente potrebbe venire richiesto di prendere le misure adeguate. Per soddisfare i requisiti CEE, il monitor e le altre periferiche vanno collegati alla scheda grafica con cavi schermati. Questi prodotti sono stati provati in un tipico sistema host conforme alla classe A. Inoltre, si dà per scontato che questi prodotti acquisiranno la conformità in qualsiasi sistema conforme alla classe A.

(Español) Información para usuarios europeos – Declaración de conformidad

Observación referente a los productos de hardware de Matrox apoyados por este manual Estos dispositivos cumplen con la directiva de la CE 2014/30/EU para dispositivos digitales de Clase A. Dichos dispositivos han sido sometidos a prueba y se ha comprobado que cumplen con las normas EN55032/CISPR32 y EN55035/CISPR35. En

entornos residenciales, estos productos pueden causar interferencias en las comunicaciones por radio; en tal caso el usuario deberá adoptar las medidas adecuadas. Para satisfacer las disposiciones de la CE, deberán utilizarse cables apantallados para conectar el monitor y demás periféricos a la tarjeta. Estos productos han sido sometidos a prueba en un típico sistema anfitrión que responde a los requisitos de la clase A. Se supone que estos productos cumplirán también con las normas en cualquier sistema que responda a los requisitos de la clase A.

EUROPE

(English) European user's information – Directive on Waste Electrical and Electronic Equipment (WEEE)

Please refer to the Matrox Web site (www.matrox.com/environment/en/weee) for recycling information.



(Français) Informations aux utilisateurs Européens – Règlementation des déchets d'équipements électriques et électroniques (DEEE)

Se référer au site Web de Matrox (www.matrox.com/environment/en/weee) pour l'information concernant le recyclage.

(Deutsch) Information für europäische Anwender – Europäische Regelungen zu Elektro- und Elektronikgeräten (WEEE)

Bitte wenden Sie sich an der Matrox-Website (www.matrox.com/environment/en/weee) für Recycling-Informationen.

(Italiano) Informazioni per gli utenti europei – Direttiva sui rifiuti di apparecchiature elettriche ed elettroniche (RAEE)

Si prega di riferirsi al sito Web Matrox (www.matrox.com/environment/en/weee) per le informazioni di riciclaggio.

FRANCE

Avertissement sur l'épilepsie

À lire avant toute utilisation d'un jeu vidéo par vous-même ou votre enfant Certaines personnes sont susceptibles de faire des crises d'épilepsie ou d'avoir des pertes de conscience à la vue de certains types de lumières clignotantes ou d'éléments fréquents dans notre environnement quotidien. Ces personnes s'exposent à des crises lorsqu'elles regardent certaines images télévisées ou qu'elles jouent à certains jeux vidéo. Ces phénomènes peuvent apparaître alors même que le sujet n'a pas d'antécédent médical ou n'a jamais été confronté à une crise d'épilepsie.

Si vous-même ou un membre de votre famille avez déjà présenté des symptômes liés à l'épilepsie (crise ou perte de conscience) en présence de stimulations lumineuses, veuillez consulter votre médecin avant toute utilisation.

Nous conseillons aux parents d'être attentifs à leurs enfants lorsqu'ils jouent avec des jeux vidéo. Si vous-même ou votre enfant présentez un des symptômes suivants: vertige, trouble de la vision, contraction des yeux ou des muscles, perte de conscience, trouble de l'orientation, mouvement involontaire ou convulsion, veuillez immédiatement cesser de jouer et consultez un médecin.

Précautions à prendre dans tous les cas pour l'utilisation d'un jeu vidéo Ne vous tenez pas trop près de l'écran.

- Jouez à bonne distance de l'écran de TV et aussi loin que le permet le cordon de raccordement.
- Utilisez de préférence les jeux de vidéo sur un écran de petite taille.
- Évitez de jouer si vous êtes fatigué ou si vous manquez de sommeil.
- Assurez-vous que vous jouez dans une pièce bien éclairée.
- En cours d'utilisation, faites des pauses de dix à quinze minutes toutes les heures.

Hot surface Allow hot surfaces to cool before touching your Matrox unit.

Surface chaude Laissez refroidir les surfaces chaudes avant de toucher votre appareil Matrox.

Battery replacement The battery is non replaceable. To dispose of your product, see www.matrox.com/environment/weee.



Remplacement des piles La pile n'est pas remplaçable. Pour se défaire du produit, voir www.matrox.com/environment/weee.

USA

FCC Compliance Statement

Remark for the Matrox hardware products supported by this guide This equipment has been tested and found to comply with the limits for a Class B digital device, pursuant to Part 15 of the FCC Rules. These limits are designed to provide reasonable protection against harmful interference in a residential installation. This equipment generates, uses and can radiate radio frequency energy and, if not installed and used in accordance with the instructions, may cause harmful interference to radio communications. However, there is no guarantee that interference will not occur in a particular installation. If this equipment causes harmful interference to radio or television reception, which can be determined by turning the equipment off and on, the user is encouraged to try to correct the interference by one or more of the following measures: • Reorient or relocate the receiving antenna • Increase the separation between the equipment and receiver • Connect the equipment into an outlet on a circuit different from that to which the receiver is connected • Consult the dealer or an experienced radio/TV technician for help.



WARNING Changes or modifications to this unit not expressly approved by the party responsible for the compliance could void the user's authority to operate this equipment.

Declaration of conformity of a Class B digital device according to the FCC rules

We, the Responsible Party Matrox, 2002 Ridge Road, Champlain, NY 12919 • Telephone: (514) 822-6000 (extension 2026) • Attention: Conformity Group Matrox

Declaration The Matrox hardware products supported by this guide comply with Part 15 of the FCC Rules. Operation is subject to the following two conditions: (1) these devices may not cause harmful interference, and (2) these devices must accept any interference received, including interference that may cause undesired operation. Any question regarding this declaration should be forwarded to the above coordinates.

CANADA

(English) Innovation, Science and Economic Development Canada

Remark for the Matrox hardware products supported by this guide These digital devices do not exceed the Class B limits for radio noise emission from digital devices set out in the Radio Interference Regulation of Innovation, Science and Economic Development Canada.

(Français) Innovation, Sciences et Développement économique Canada

Remarque sur les produits matériels Matrox couverts par ce guide Ces appareils numériques n'émettent aucun bruit radioélectrique dépassant les limites applicables aux appareils numériques de Classe B prescrites dans le Règlement sur le brouillage radioélectrique édicté par Innovation, Sciences et Développement économique Canada.

JAPAN

VCCI Compliance Statement

Remark for the Matrox hardware products supported by this guide This is a Class B product based on the standard of the Voluntary Control Council for Interference from Information Technology Equipment



(VCCI). If this is used near a radio or television receiver in a domestic environment, it may cause radio interference. Install and use the equipment according to the instruction manual.

この装置は、クラスB情報技術装置です。この装置は、家庭環境で使用することを目的としていますが、この装置がラジオやテレビジョン受信機に近接して使用されると、受信障害を引き起こすことがあります。

取扱説明書に従って正しい取り扱いをして下さい。 VCCI-B

KOREA

B 급 기기 (가정용 방송통신기자재)

이 기기는 가정용 (B 급) 전자파적합기기로서 주로 가정에서 사용하는 것을 목적으로 하며, 모든 지역에서 사용할 수 있습니다.

EUROPE

(English) European user's information – Information on Conformity

Remark for the Matrox hardware products supported by this guide These devices comply with EC Directive 2014/30/EU for a Class B digital device. They have been tested and found to comply with EN55032/CISPR32 and EN55024/CISPR24. In a domestic environment these products may cause radio interference in which case the user may be required to take adequate measures. These products have been tested in a typical class B compliant host system. It is assumed that these products will also achieve compliance in any class B compliant system.



(Français) Informations aux utilisateurs Européens – Informations sur la conformité

Remarque sur les produits matériels Matrox couverts par ce guide Ces unités sont conformes à la directive communautaire 2014/30/EU pour les unités numériques de classe B. Les tests effectués ont prouvé qu'elles sont conformes aux normes EN55032/CISPR32 et EN55024/CISPR24. Le fonctionnement de ces produits dans un environnement résidentiel peut causer des interférences radio, dans ce cas l'utilisateur peut être amené à prendre les mesures appropriées. Ces produits ont été testés dans un système hôte typique compatible classe B. On suppose qu'ils présenteront la même compatibilité dans tout système compatible classe B.

(Deutsch) Information für europäische Anwender – Konformitäts-Informationen

Anmerkung für die Matrox Hardware-Produktunterstützung durch dieses Handbuch Diese Geräte entsprechen EC Direktive 2014/30/EU für ein digitales Gerät Klasse B. Sie wurden getestet und entsprechen demnach EN55032/CISPR32 und EN55024/CISPR24. In einer Wohnumgebung können diese Produkte Funkinterferenzen erzeugen, und der Benutzer kann genötigt sein, entsprechende Maßnahmen zu ergreifen. Diese Produkt wurden in einem typischen, der Klasse B entsprechenden, Host-System getestet. Es wird davon ausgegangen, daß diese Produkte auch in jedem Klasse B entsprechenden System entsprechend funktionieren.

(Italiano) Informazioni per gli utenti europei – Informazioni sulla conformità

Nota per i prodotti hardware Matrox supportati da questa guida Questi dispositivi sono conformi alla direttiva CEE 2014/30/EU relativamente ai dispositivi digitali di Classe B. Sono stati provati e sono risultati conformi alle norme EN55032/CISPR32 e EN55024/CISPR24. In un ambiente domestico, questi prodotti possono causare radiointerferenze, nel qual caso all'utente potrebbe venire richiesto di prendere le misure adeguate. Questi prodotti sono stati provati in un tipico sistema host conforme alla classe B. Inoltre, si dà per scontato che questi prodotti acquisiranno la conformità in qualsiasi sistema conforme alla classe B.

(Español) Información para usuarios europeos – Información sobre la conformidad

Observación referente a los productos de hardware de Matrox apoyados por este manual Estos dispositivos cumplen con la directiva de la CE 2014/30/EU para dispositivos digitales de Clase B. Dichos dispositivos han sido sometidos a prueba y se ha comprobado que cumplen con las normas EN55032/CISPR32 y EN55024/CISPR24. En

entornos residenciales, estos productos pueden causar interferencias en las comunicaciones por radio; en tal caso el usuario deberá adoptar las medidas adecuadas. Se supone que estos productos cumplirán también con las normas en cualquier sistema que responda a los requisitos de la clase B.

EUROPE

(English) European user's information – Directive on Waste Electrical and Electronic Equipment (WEEE)

Please refer to the Matrox Web site (www.matrox.com/environment/en/weee) for recycling information.



(Français) Informations aux utilisateurs Européens – Règlementation des déchets d'équipements électriques et électroniques (DEEE)

Se référer au site Web de Matrox (www.matrox.com/environment/en/weee) pour l'information concernant le recyclage.

(Deutsch) Information für europäische Anwender – Europäische Regelungen zu Elektro- und Elektronikaltgeräten (WEEE)

Bitte wenden Sie sich an der Matrox-Website (www.matrox.com/environment/en/weee) für Recycling-Informationen.

(Italiano) Informazioni per gli utenti europei – Direttiva sui rifiuti di apparecchiature elettriche ed elettroniche (RAEE)

Si prega di riferirsi al sito Web Matrox (www.matrox.com/environment/en/weee) per le informazioni di riciclaggio.

FRANCE

Avertissement sur l'épilepsie

À lire avant toute utilisation d'un jeu vidéo par vous-même ou votre enfant Certaines personnes sont susceptibles de faire des crises d'épilepsie ou d'avoir des pertes de conscience à la vue de certains types de lumières clignotantes ou d'éléments fréquents dans notre environnement quotidien. Ces personnes s'exposent à des crises lorsqu'elles regardent certaines images télévisées ou qu'elles jouent à certains jeux vidéo. Ces phénomènes peuvent apparaître alors même que le sujet n'a pas d'antécédent médical ou n'a jamais été confronté à une crise d'épilepsie.

Si vous-même ou un membre de votre famille avez déjà présenté des symptômes liés à l'épilepsie (crise ou perte de conscience) en présence de stimulations lumineuses, veuillez consulter votre médecin avant toute utilisation.

Nous conseillons aux parents d'être attentifs à leurs enfants lorsqu'ils jouent avec des jeux vidéo. Si vous-même ou votre enfant présentez un des symptômes suivants: vertige, trouble de la vision, contraction des yeux ou des muscles, perte de conscience, trouble de l'orientation, mouvement involontaire ou convulsion, veuillez immédiatement cesser de jouer et consultez un médecin.

Précautions à prendre dans tous les cas pour l'utilisation d'un jeu vidéo Ne vous tenez pas trop près de l'écran.

- Jouez à bonne distance de l'écran de TV et aussi loin que le permet le cordon de raccordement.
- Utilisez de préférence les jeux de vidéo sur un écran de petite taille.
- Évitez de jouer si vous êtes fatigué ou si vous manquez de sommeil.
- Assurez-vous que vous jouez dans une pièce bien éclairée.
- En cours d'utilisation, faites des pauses de dix à quinze minutes toutes les heures.

Trademarks • Marques déposées • Warenzeichen • Marchi registrati • Marcas registradas

Matrox Electronic Systems Ltd. /

Matrox Graphics Inc.	Matrox [®] , DualHead [®] , Avio [™] , C-Series [™] , D-Series [™] , DualHead2Go [™] , Extio [™] , G400 [™] , G450 [™] , G550 [™] , GXM [™] , Maevex [™] , Marvel [™] , MED2mp [™] , MED2mp-DVI [™] , MED3mp-DVI [™] , MED4mp [™] , MED5mp-DVI [™] , MED5mp [™] , Millennium [™] , MMS [™] , Multi-Monitor Series [™] , MultiDesk [™] , Mura [™] , MuraControl [™] , Mystique [™] , P650 [™] , P690 [™] , P750 [™] , Parhelia [™] , Parhelia [™] APVe, Parhelia-512 [™] , Parhelia-LX [™] , Parhelia HR256 [™] , PJ4OLP [™] , QID [™] , Quad Information Display [™] , RAD [™] , Quick Connect [™] , MaxVIEW [™] , Onyx [™] , PixelTOUCH [™] , PrecisionCAD [™] , Precision SGT [™] , QuadHead2Go [™] , QuickDesk [™] , RAD2mp [™] , RAD3mp [™] , RAD9mp [™] , RADQ2mp [™] , Rainbow Runner [®] , TheatreVUE [™] , TripleHead [™] , TripleHead2Go [™] , VDA [™] , Veos [™] , Xenia [™]
Adobe Systems Inc.	Acrobat [®] , Reader [®]
Advanced Micro Devices, Inc.	AMD [®]
Apple Computer, Inc.	App Store [®] , Apple [®] , iPad [®] , Mac [®] , Mac OS [®]
Belden Inc.	Belden [®]
Dolby Laboratories, Inc.....	Dolby [®] , Dolby Digital [®]
Facebook, Inc.	Facebook [®]
Google, Inc.....	YouTube [®]
HDMI Licensing LLC.....	HDMI [®]
Intel Corporation	Intel [®]
International Business Machines	IBM Video Streaming [™]
Linus Torvalds.....	Linux [®]
Microsoft Corporation.....	Active Directory [®] , Aero [®] , Direct3D [®] , DirectShow [®] , DirectX [®] , Microsoft [®] , MS-DOS [®] , PowerPoint [®] , Windows [®] , Windows NT [®] , Windows Server [®] , Windows Vista [®]
NVIDIA Corporation	NVIDIA [®]
Panopto, Inc.	Panopto [™]
PCI-SIG.....	PCI [™] , PCI-X [®] , PCIe [®] , PCI Express [®]
Radio Corporation of America	RCA [®]
RealVNC Ltd.	VNC [®]
Restream, Inc.....	Restream [™]
SD-3C, LLC.....	SD [™] , SDHC [™] , SDXC [™]
Silicon Graphics, Inc.	OpenGL [®]
Silicon Image, Inc.....	PanelLink [®] , TMDS [®]
Twitch Interactive, Inc.....	Twitch [™]
U.S. Environmental Protection Agency.....	ENERGY STAR [®]
Video Electronics Standards Association	DisplayPort [™]
VideoLAN	VideoLAN [®] , VLC [®] , VLC [®] media player
Vimeo, LLC	Vimeo [®]

Wibu-Systems WIBU®
Wowza Media Systems, LLC..... Wowza™

Copyright © 1996-2020 VideoLAN. This logo or a modified version may be used or modified by anyone to refer to the VideoLAN project or any product developed by the VideoLAN team, but does not indicate endorsement by the project.

HTML5 Logo by World Wide Web Consortium ([W3C](http://www.w3.org)). This HTML5 logo is licensed under this Public License (<http://www.creativecommons.org/licenses/by/3.0/legalcode>). The logo has been modified to meet the resolution and size required by this application.

• (English) Registered trademarks are registered in the United States, Canada, and/or other countries. All other nationally and internationally recognized trademarks and tradenames are hereby acknowledged. • (Français) Les marques déposées sont déposées aux États-Unis, au Canada et/ou dans d'autres pays. Toutes les autres marques et tous les autres noms déposés reconnus nationalement ou internationalement sont également reconnus par les présentes. • (Deutsch) Die eingetragenen Warenzeichen sind in den USA, Kanada und/oder anderen Ländern registriert. Alle sonstigen national und international bekannten Warenzeichen und Produktnamen werden hiermit anerkannt. • (Italiano) I marchi registrati sono registrati negli Stati Uniti, in Canada e/o in altri paesi. Tutti gli altri marchi registrati e nomi commerciali riconosciuti a livello nazionale e internazionale sono ugualmente riconosciuti qui. • (Español) Las marcas registradas están registradas en los EE.UU., Canadá u otros países. Por medio del presente se reconocen todas las demás marcas y nombres comerciales reconocidos a nivel nacional e internacional.

(English) Disclaimer

THE INFORMATION IN THIS GUIDE IS SUBJECT TO CHANGE AT ANY TIME AND WITHOUT NOTICE.

Matrox Graphics Inc. reserves the right to make changes in specifications at any time and without notice. The information provided by this document is believed to be accurate and reliable at the time it is written. However, no responsibility is assumed by Matrox Graphics Inc. for its use, for its reproduction and/or distribution, in whole or in part; nor for any infringements of patents or other rights of third parties resulting from its use.

(Français) Responsabilité

LES INFORMATIONS CONTENUES DANS CE MANUEL PEUVENT ÊTRE MODIFIÉES EN TOUT TEMPS ET CE SANS PRÉAVIS.

Les Graphiques Matrox Inc. se réserve le droit de modifier les spécifications en tout temps et ce sans préavis quelconque. Les informations contenues dans ce manuel sont reconnues comme étant précises et fiables à la date de rédaction. Cependant, Matrox Graphics Inc. n'assume aucune responsabilité concernant leur utilisation, leur reproduction et/ou distribution, en tout ou en partie, ni leur contrefaçon de brevets ou de tout autre droit appartenant à des tiers résultant de leur utilisation. Aucune licence n'est accordée sur aucun brevet ou droit d'exploiter un brevet de Matrox Graphics Inc.

(Deutsch) Haftungsablehnungserklärung

DIE IN DIESEM HANDBUCH ENTHALTENEN ANGABEN UND DATEN KÖNNEN OHNE VORHERIGE ANKÜNDIGUNG GEÄNDERT WERDEN.

Die Matrox Graphics Inc. behält sich das Recht vor, jederzeit und ohne Ankündigung technische Daten zu ändern. Zum Zeitpunkt der Erstellung dieses Handbuchs sind die Inhalte korrekt und verlässlich. Weiterhin übernimmt Matrox Graphics Inc. keinerlei Verantwortung für die Benutzung dieses Handbuchs, die Vervielfältigung und/oder Verteilung im Ganzen oder zum Teil; weder für Verstöße gegen Patentrechte noch für andere Rechte Dritter, die aus seinem Gebrauch resultieren mögen. Es werden keinerlei Lizenzrechte gewährt für sämtliche Patente oder Patentrechte der Matrox Graphics Inc.

(Italiano) Discrezionalità

LE INFORMAZIONI CONTENUTE NEL PRESENTE DOCUMENTO SONO SOGGETTE A MODIFICHE IN QUALUNQUE MOMENTO E SENZA PREAVVISO.

Matrox Graphics Inc. si riserva il diritto di apportare variazioni di qualunque tipo alle specifiche tecniche in qualunque momento e senza alcun preavviso. Le informazioni contenute in questa documentazione sono ritenute corrette e attendibili al momento della pubblicazione. In ogni caso, non è imputabile a Matrox Graphics Inc. nessuna responsabilità per il loro utilizzo, per la loro distribuzione e/o riproduzione completa o in parte, come nessuna violazione a brevetti o diritti di altri produttori derivante dal loro utilizzo.

(Español) Renuncia

LA INFORMACION QUE CONTIENE EL PRESENTE MANUAL ESTA SUJETA A CAMBIOS SIN PREVIO AVISO EN CUALQUIER MOMENTO.

Matrox Graphics Inc. se reserva el derecho de realizar modificaciones en cualquier momento y sin previo aviso. La información facilitada en este documento se considera que es exacta y fiable hasta la fecha de publicación. Sin embargo, Matrox Graphics Inc. no asume ninguna responsabilidad por su uso, por su reproducción y/o distribución parcial o total; ni por cualquier infracción de patentes u otros derechos de terceras partes derivados de su uso. No se concede ninguna licencia bajo cualesquiera patentes o derechos de patentes de Matrox Graphics Inc.

Matrox Graphics Inc.

1055 Saint Regis Boulevard
Dorval, Quebec, Canada H9P 2T4
(514) 822-6000

video@matrox.com
www.matrox.com/video

matrox[®]
— video —