



Matrox® **PowerStream Plus**

User Guide

20246-301-0425
2024.02.13

video.matrox.com

matrox®
— video —

1	Matrox PowerStream Plus software	6
1.1	Before you begin.....	6
1.2	Installing your software	8
1.3	Accessing Matrox PowerStream Plus.....	8
1.4	More information	8
2	Getting started	9
2.1	Starting Matrox PowerStream Plus for the first time.....	9
2.2	PowerStream Plus main interface	10
2.3	PowerStream Plus main menu	11
2.4	PowerStream Plus basic functions	12
2.5	Understanding your Maevox environment	13
2.6	Understanding your Maevox devices	14
2.7	Information dashboard.....	16
2.8	Understanding the status of your devices.....	18
3	Adding devices to your environment	20
3.1	Network discovery	20
3.2	Manual device discovery.....	21
3.3	Administrative control on a Maevox 6100 Series device.....	22
4	Managing users and passwords	23
4.1	Environment password.....	23
4.2	Device password.....	23
4.3	Maevox 5100 Series	23
4.4	Maevox 6100 Series	25
4.5	Maevox 7112 encoders	37
5	Processing overview	40
5.1	Encoding process overview.....	40
5.2	Decoding process overview.....	41

6	Maevox 7112 encoder settings	43
6.1	Video input.....	44
6.2	Stream settings.....	44
6.3	Device settings.....	54
6.4	Device temperature.....	57
6.5	About	57
6.6	Logout.....	58
6.7	Reboot.....	58
7	Maevox 6152 decoder settings	59
7.1	Decoding.....	59
7.2	Layouts.....	66
7.3	Messaging overlay	77
7.4	Network	78
7.5	RS232	80
7.6	Date and time	81
7.7	Local storage.....	82
7.8	Other.....	84
7.9	Modify settings	87
7.10	Managing your Maevox 6152 Decoder configurations	87
7.11	Warning messages for a 6152 decoder	87
8	Maevox 6152 encoder settings	89
8.1	Processing.....	89
8.2	Network.....	104
8.3	RS232	106
8.4	Date and time.....	107
8.5	Other.....	108
9	Maevox 6122 encoder settings	111
9.1	Processing.....	111
9.2	Network.....	125
9.3	RS232	126
9.4	Date and time	128
9.5	Other.....	128

10 Maevox 6100 encoder settings	132
10.1 Processing	132
10.2 Network	144
10.3 Date and time	145
10.4 Other	145
11 Maevox 5150 encoder settings	146
11.1 Processing	146
11.2 Local output (for encoder)	152
11.3 Network	155
11.4 RS232	156
11.5 Date and time	157
12 Maevox 5150 decoder settings	158
12.1 Decoding	158
12.2 Local output (for decoder)	161
12.3 Network	163
12.4 RS232	164
12.5 Date and time	166
12.6 Failsafe	166
13 Managing your configurations	167
14 Adjusting the date and time of your device	169
14.1 Setting the date and time	169
14.2 Setting the time zone	170
15 Troubleshooting	171
15.1 What to do if you have a problem	171
15.2 Common problems and solutions	171
16 Notes and limitations	185
16.1 General	185
16.2 Protected content	188
16.3 Audio	188
16.4 Recording	189
16.5 Date and time	189
16.6 Network	189

17 Appendix – Firewall requirements	190
17.1 PowerStream Plus software	190
17.2 Firmware updater	190
17.3 Maevex devices	191
17.4 Accessing your Windows Firewall settings	192
17.5 Adding rules to your Windows Firewall settings	192
18 Customer support	194
18.1 Matrox web	194
18.2 Technical support	194
18.3 Firmware package	194
18.4 View your warranty information	194
18.5 View the third party software notices	195
18.6 Register your Matrox product	195

1 Matrox PowerStream Plus software



Matrox PowerStream Plus software enables you to remotely control, manage, and configure your Maevox encoders and decoders from a controller system in your Maevox environment.



Note: This guide describes all Matrox PowerStream Plus features and controls. However, the support and availability of some of the Matrox features and controls detailed in this document depends on your product and software version.

1.1 Before you begin

To get the most out of your product:

- Make sure you connect your product *before* configuring PowerStream Plus software. For more information on the connection setup of your product, see the user guide for your Matrox hardware.
- Make sure *all* of your Maevox devices are using the latest version of the Matrox Maevox firmware. Download and install the Matrox Maevox firmware package version that matches the latest Matrox PowerStream Plus software version (with the same release date). For more information, see the Matrox Maevox Series Firmware Updater document. **Note:** If the versions do not match, the device will not be detected.
- Install the latest version of the Matrox PowerStream Plus software.
- Maevox 6100 Series – Identify a *Maevox environment administrator* who will take control of the Maevox 6100 Series devices that are detected for the first time, create users on the Maevox devices, and set their permissions.
- Make sure you have the administrator rights that may be needed to install or uninstall certain software. For more information, see Windows documentation or contact your system administrator.
- Identify a DHCP (Dynamic Host Configuration Protocol) server that will be used to assign an initial IP address to your encoders and decoders.
- Windows Server 2022 and Server 2019 – Make sure the SSDP Discovery service, network discovery, and file sharing options are enabled.

1.1.1 Match software and firmware versions

- The version of your firmware package must match the version of your PowerStream Plus software package. If not, a warning message displays, and your device won't be detected.

1.1.2 Supported operating systems

Matrox PowerStream Plus supports the following operating systems:

- Windows® Server® 2022
- Windows® Server® 2019
- Windows® 11 (64-bit)
- Windows® 10 (64-bit)



Note: Windows® Server® 2019 and Windows® Server® 2022 are not supported in MaeveX 7100 Series.

1.1.3 Supported Matrox hardware

Matrox PowerStream Plus supports the following Matrox hardware:

- MaeveX 7100 Series
 - MaeveX 7112A encoder
 - MaeveX 7112H encoder
- MaeveX 6100 Series
 - MaeveX 6152 decoder
 - MaeveX 6152 encoder
 - MaeveX 6122 encoder
 - MaeveX 6100 encoder
- MaeveX 5100 Series
 - MaeveX 5150 encoder
 - MaeveX 5150 decoder



Note: Though the MaeveX 6150 and 6120 devices have been superseded by the MaeveX 6152 and 6122 devices, the MaeveX 6150 and 6120 devices remain forward compatible and are supported by the latest PowerStream Plus software and the MaeveX firmware.

1.1.4 Obtaining Matrox PowerStream Plus

Matrox makes the latest PowerStream Plus software available on the Matrox web site (video.matrox.com/maevexsw).

1.2 Installing your software

To install the software for your MaeveX product, run the installation program for your software package. Follow the on-screen instructions.

1.3 Accessing Matrox PowerStream Plus

Windows 11/10 – To access the main interface of PowerStream Plus:

- Windows 11/10 – Click **Start** → **All apps*** → **Matrox PowerStream Plus*** → **Matrox PowerStream Plus**. (* Depending on your configuration of Windows, this part may not be necessary.)

1.4 More information

This guide assumes your Matrox product is properly connected. For more information on the connection setup of your product, see the user guide for your Matrox hardware.

Be sure to check for any last-minute release notes included with your product. Also, check the Matrox web site (video.matrox.com) for the latest Matrox software, technical support, and product information.

2 Getting started

This section describes the main interface, the main menu, and the basic functions of the Matrox PowerStream Plus software. It also provides an overview of your MaeveX environment and devices.

2.1 Starting Matrox PowerStream Plus for the first time

MaeveX 6100 Series only – When you install and start PowerStream Plus software for the first time, you'll be asked if you're a MaeveX environment administrator. **Note:** We recommend that the *MaeveX environment administrator* starts the Matrox PowerStream Plus software for the first time.

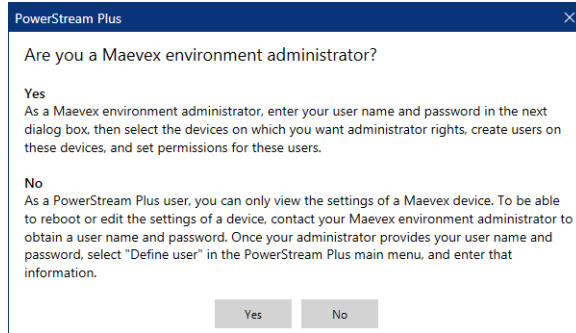

- If you're a MaeveX environment administrator, click **Yes**. You'll be prompted to enter your user name and device password. As a MaeveX environment administrator, you need to take control of the MaeveX 6100 Series devices that are detected for the first time. You also need to create users on the MaeveX devices and set their permissions. For more information, see ["4.4.8.1 - Assign the MaeveX environment administrator"](#), page 34 and see ["4.4.8.2 - Adding yourself as a device administrator"](#), page 34.
- If you're not a MaeveX environment administrator, click **No**. Contact your MaeveX environment administrator to obtain a user name and device password. Once you've obtained a user name and password, go to the main menu, click **Log in**, and enter that information.

2.2 PowerStream Plus main interface



A	Main menu	The PowerStream Plus main menu contains options for managing users and passwords. For more information see “2.3 - PowerStream Plus main menu”, page 11.
B	Device groups	The Maevex devices (encoders and decoders) in your Maevex environment are depicted as colored tiles and sorted into groups. For more information, see “2.6 - Understanding your Maevex devices”, page 14.
C	Device tiles	The Maevex devices (encoders and decoders) in your Maevex environment are depicted as colored tiles. For more information, see “2.6 - Understanding your Maevex devices”, page 14.
D	Information dashboard	The dashboard provides information for a device (such as the device type, serial number, firmware version, name, IP address, date, time, and status). For more information, see “2.7 - Information dashboard”, page 16.
E	Device filtering	The devices are filtered by status, permissions, and type. For more information, see “2.6.3 - Filtering your device tiles”, page 16.
F	Basic functions	These buttons provide the basic functions for PowerStream Plus software. For more information, see “2.4 - PowerStream Plus basic functions”, page 12.

2.3 PowerStream Plus main menu

The main menu of PowerStream Plus contains the following options.

Manual device discovery	PowerStream Plus automatically detects and adds new devices to your MaeveX environment. If devices aren't automatically detected, you can manually add devices to your MaeveX environment. For more information, see “3.2 - Manual device discovery” , page 21.
MaeveX 5100 Series	<ul style="list-style-type: none">▪ Change password – Change the password for your MaeveX 5100 Series products. For more information, see “4 - Managing users and passwords”, page 23.
MaeveX 6100 Series	<ul style="list-style-type: none">▪ Change password – Change the password for your MaeveX 6100 Series products. For more information, see “4 - Managing users and passwords”, page 23.▪ Log in/Log out – Log local or domain user credentials into PowerStream Plus for the MaeveX 6100 Series devices on your network. For more information, see “4.4.7 - Logging in and out”, page 27.▪ Manage users – Manage the users for your MaeveX 6100 Series products. For more information, see “4.4.8 - Managing your MaeveX 6100 Series users”, page 33.
MaeveX 7100 Series	<ul style="list-style-type: none">▪ Log in/Log out – Log local or domain user credentials into PowerStream Plus for the MaeveX 7100 Series devices on your network. For more information, see “4.4.7 - Logging in and out”, page 27.
About	Provides information specific to your PowerStream Plus software (such as the version).

2.3.1 PowerStream Plus shortcut menu

To access the shortcut menu, right-click your device tile. The menu items available will vary depending on your product and setup. The menu items include:

Reboot	Click this to reboot your device (for the 6100 Series devices, you can select and reboot a group of devices of the same type). This keeps all of your device settings, including the IP address and password. After rebooting your device, allowed connections are restored.
Multi-device settings	Select multiple device tiles of the same type (for example, only 5100 Series devices or only 6100 Series devices), then click this to see the settings for those devices.
Wake-on-LAN control	6152 / 6122 encoder and 6152 decoder only – Click this to remotely reboot your MaeveX device if it's unresponsive.

Open settings	Click this to see the settings for your device. This opens the last page accessed.
Remove lost devices	Click this to remove a device that's listed as Lost (dark grey) or Undetected (black).
Move to group	To create a new tile group, right-click a tile, select Move to group → Create a new device group , then enter a new Name . The tile used to create the new group moves to that new group. For more information, see “2.6.1 - Device groups”, page 15.

2.4 PowerStream Plus basic functions

The following buttons provide basic functions for managing your PowerStream Plus software.

Reboot	Click this to reboot your device. This keeps all of your device settings, including the IP address and password. After rebooting a device already encoding or decoding, the device automatically restarts that process.
Apply / Cancel	Click Apply for your changes to take effect. Click Cancel to discard any changes that weren't applied.
Back	Click this to return to the MaeveX environment.
Open settings	Click this to see the settings for your device. This opens the last page accessed.
Multi-device settings	Select multiple device tiles of the same type (for example, only 5100 Series devices or only 6100 Series devices), then click this to see the settings for those devices.

2.4.1 Modify settings

To modify the settings for multiple devices at the same time:

- 1 From the PowerStream Plus main interface, press the [Ctrl] key, select the tiles of the devices you want to modify, then click **Multi-device settings**. The device tiles you select must be of the same type.
- 2 Select your preferred device.
- 3 Enable the **Modify settings** option, then make your changes. **Note:** You need to select your device first before you enable the **Modify settings** option, otherwise an error message will display and your changes will not be saved.
- 4 When you're done, click **Apply**. This applies the settings from the preferred device to the other selected devices.

2.5 Understanding your Maeve environment

Matrox Maeve devices work together to provide unicast (one-to-one) or multicast (one-to-many) streaming over an IP network. Using Matrox PowerStream Plus software, you can manage your entire Maeve network from a single system or multiple systems.

A Matrox Maeve environment can be made up of the following elements connected to a network:

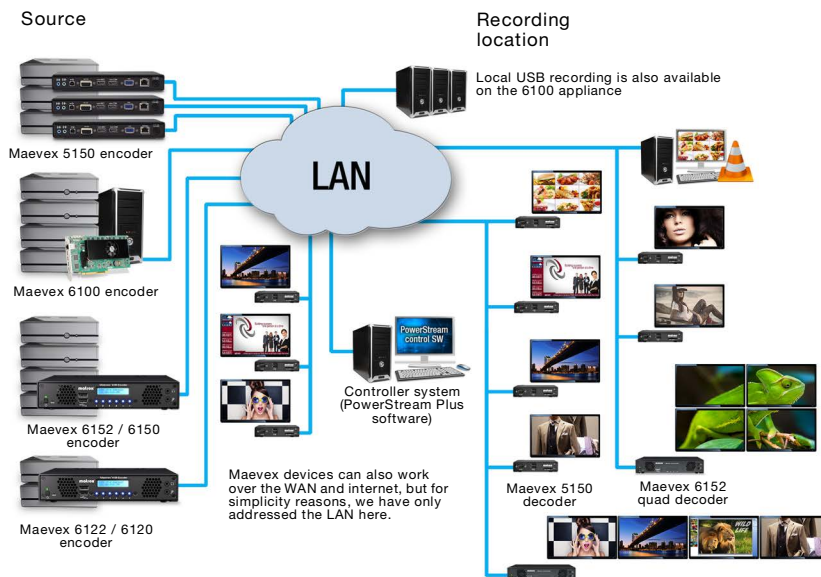

Source	A video source connected to the input of an encoder. A controller system can be used as a source.
Maeve 7112 encoder	A single-input ultra low latency streaming appliance. Supports 4K60 input.
Maeve 6152 decoder	A quad-output 4K decoder appliance that works with the entire Maeve product line as well as third-party encoders. Efficiently decodes up to four 4K streams, or many more lower resolution streams.
Maeve 6152 encoder	An encoder appliance that supports four (4) 4K60 inputs with HDCP and can generate multiple streams and recordings. A Maeve 6152 encoder can stream to one or more decoders.
Maeve 6122 encoder	An encoder appliance that supports two (2) 4K60 inputs with HDCP and can generate multiple streams and recordings. An encoder can stream to one or more decoders.

Maevox 6100 encoder	An encoder with four (4) inputs support that can generate multiple streams and recordings. An encoder can stream to one or more decoders.
Maevox 5150 encoder	An encoder with single input support that can generate a single stream or recording. An encoder can stream to one or more decoders.
Maevox 5150 decoder	A decoder with a single Full HD output that decodes and displays any Maevox or third-party encoder's RTSP HD stream that is available on the network. A decoder is needed for each stream from an encoder in your environment.
Third-party decoder	Third-party video players (such as VideoLAN® VLC® media player) can also be used to decode the signal from an encoder.
Recording location	The location (such as a Network Attached Storage (NAS) device or a network shared folder) used by a Maevox encoder to record a file.
Controller system	A system connected to the network and running Matrox Maevox PowerStream Plus. A controller system can be used as a source and as a recording location.

2.6 Understanding your Maevox devices

In PowerStream Plus, the Maevox devices (encoders and decoders) in your Maevox environment are depicted as colored tiles and sorted into groups.

^ New devices 13 items

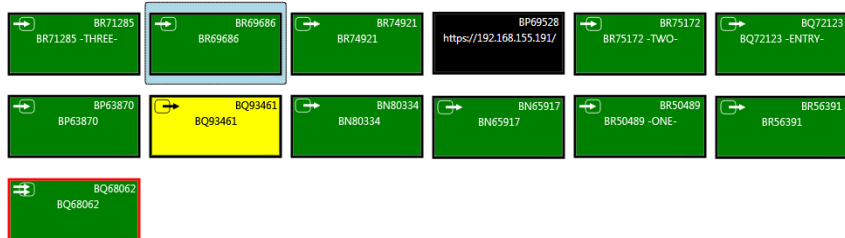

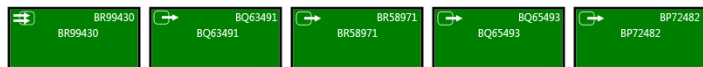

^ Group 1 5 items



2.6.1 Device groups

When PowerStream Plus is started for the first time, or whenever a new device is detected, the device or devices are added to the **New devices** group. These devices can then be sorted into *groups*.





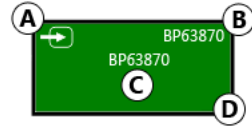

Managing your device groups

- To collapse or expand the tile list under a group, click the arrow ( / ).
- To create a new tile group, right-click a tile, select **Move to group** → **Create a new device group**, then enter a new **Name**. The tile used to create the new group moves to that new group.
- To reorder your groups, right-click next to the group name, then select a location for that group in the group list.
- To rename a group, click the group name, then enter a new name for the group.
- To remove a group, move all the tiles out of a group.

2.6.2 Device tiles

The tile provides the following information about your device .



A	<p>Device type identified by icon:</p> <ul style="list-style-type: none"> ▪  – Mae vex 7112 encoder ▪  – Mae vex 6152 quad decoder ▪  – Mae vex 6152 quad encoder ▪  – Mae vex 6122 dual encoder ▪  – Mae vex 6100 quad encoder ▪  – Mae vex 5150 encoder ▪  – Mae vex 5150 decoder
B	Device serial number.
C	Device name, device serial number, or IP address, depending on the status of the Mae vex device.
D	Device status (tile color and border color). For more information, see “2.8 - Understanding the status of your devices”, page 18.



Note: When a new Mae vex 6100 Series device is added to a network environment for the first time (or a factory reset is done), there is no administrator associated with it. In this case, an administrator has to take ownership (administrative control) of the device. For more information, see “4.4.8.2 - Adding yourself as a device administrator”, page 34.

Managing your device tiles

- To reorder your tiles, drag a tile to a new location.
- To move a tile to a different group, drag the tile to a new group. You can also right-click the tile, and select a group.
- To access the settings of a device, select a device, then click **Open settings**.
- To rename a device, click **Open settings**, then enter a new **Name** for that device.
- To delete a device, click the **Delete** (✕) icon.

2.6.3 Filtering your device tiles

You can filter your devices by *status*, *permissions*, and *device type*. The number at the top indicates the total number of devices. The number in the colored tiles indicate the number of devices with that status.

To filter your devices, click the appropriate tile. You can select multiple tiles to view devices with a different status. While filtering is in effect, at least one tile is highlighted.

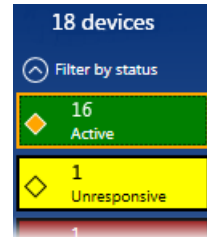

2.7 Information dashboard

The information dashboard provides the current status and information of a device. The dashboard also enables you to copy the addresses of your streams to the clipboard.

2.7.1 Opening the information dashboard

Select the device, then click the expand icon (⌵) at the bottom of the PowerStream Plus main interface. This opens the information dashboard.

Identity & Version	Telemetry	Inputs	Local output (preferred mode)	Streams
CBS7895 Maveve 6190 Quad Encoder Firmware version: 3.00.00341	2021-01-05 10:34:38 AM Device temperature: 68.0°C Max. temperature supported: 100.0°C	Digital A/V Input 1: 1920 x 1080p @ 60.00 Hz No audio Digital A/V Input 2: 1920 x 1080p @ 59.94 Hz Audio connected Digital A/V Input 3: 1920 x 1080p @ 59.94 Hz No audio Digital A/V Input 4: No audio No video Analog Audio Input 1: No audio Analog Audio Input 2: No audio Analog Audio Input 3: No audio Analog Audio Input 4: No audio Microphone: No audio	HDMI 1: LG LG TV 1920 x 1080p @ 60.00 Hz HDMI 2: NEC V404 1920 x 1080p @ 60.00 Hz HDMI 3: No monitor HDMI 4: No monitor	RTSP on port 1027 rtsp://192.168.2.20:3049/S1 59.94 frames/s 2.86 Mb/s RTSP on port 1028 rtsp://192.168.2.20:3049/S2 1280 x 720 @ 60.00 Hz 60 frames/s 2.86 Mb/s SRT on port 1026 1920 x 1080 @ 59.94 Hz 59.94 frames/s 2.86 Mb/s

The information displayed for the device includes the following:

- Device type

- Serial number (displayed when the device is not active), or the friendly name of the active device (the default friendly name for the device is its serial number)
- Firmware version
- Name
- IP address
- Date and Time
- Status
- Telemetry details such as device temperature and maximum temperature supported

2.7.2 Maevox 6152 decoder details

For the Maevox 6152 decoder, additional telemetry details displayed are CPU usage, memory, video decoding, and video processing.

Telemetry	Outputs	Streams
12/15/2020 3:04:23 PM CPU: 4.96% Video decoding: 20.21% Video processing: 12.00% Memory: 28.05% Device temperature: 58.40°C Max. temperature supported: 100.00°C	HDMI 1 Goldstar Company Ltd LG Ultra HD 1920x1080p @ 59.94 Hz Latency 47.940 ms HDCP not supported HDMI Rev 2.0 HDMI 2 Dell Inc. DELL U2718Q 1680x1050p @ 59.95 Hz Latency 42.882 ms HDCP not supported HDMI Rev 2.0 HDMI 3: No monitor HDMI 4: No monitor Output 5: disconnected audio	VCTeam Encoder -> RTSP, on port 1030 rtsp://192.168.154.186:3049/S2  Playing, 1680 x 1050, 59.95 fps, YUV 4:2:0 8 bits, 8.24 Mb/s, 44 kHz, 2 Channels, LC (Maevox source) 154.66 -> RTSP, on port 15000 rtsp://192.168.154.66:3049/S1  Playing, 1920 x 1080, 59.99 fps, YUV 4:2:0 8 bits, 16.83 Mb/s, 44 kHz, 2 Channels, LC (Maevox source)

Other details you can see are:

- **Outputs** - All four video outputs and the audio output details, including whether they are HDCP protected, and the current latency information (displayed when there is a low latency setup between the encoder and the decoder). **Note:** **Latency** information will not appear when the low latency mode is inactive (disabled either manually or automatically), for example, when latency-inducing options like compositing and scaling are required.
- **Streams** - Stream details for every stream used.

2.7.2.1 Latency details

Latency is the time delay between when a video is captured and when it is displayed on a viewing surface. For the Maevox 6152 decoder, the glass-to-glass latency detail is displayed in the information dashboard when it is set up in a low-latency configuration with the encoder. The number represents the encoder, network, and decoder latencies together (HDMI capture to HDMI display).

When a fixed latency is set in **Latency (ms)** in the **Layout** settings page, the latency value is displayed here. If the value set is not sufficient, a warning appears.

When the stream or streams are displayed on an output in synchronized mode, the latency is displayed. **Note:** The stream or streams must come from the same MaeveX encoder, via a private communications channel between a MaeveX 6100 series encoder and a MaeveX 6152 decoder, and have the same latencies set.

2.7.2.2 Low-latency configuration (6100 Series)

For a low-latency configuration, you need to set up the encoder and decoder as detailed below.

Encoder:



- The encoder should be a MaeveX 6100 Series running version 3.00.00 or later.
- The encoder must be set up to encode the captured stream without video scaling, composition, or modification in the color ProcAmps, and the **Encoding mode** should be set to either **Optimized for low latency**, or **Optimized for desktop** in the PowerStream Plus software.





Decoder:

- The decoder has to be set up to decode the video stream without video scaling, composition, or modification in the color ProcAmps, and display it directly onto the monitor, which has to be set at the same resolution and refresh rate as the stream.
- Select a 1 x 1 (single stream) panel canvas.
- Select audio and video from the same stream.
- Do not select any of the **Overlay** options - **Enable to display the media names over the screen** or **Enable to display the audio icons over the screen**.



2.8 Understanding the status of your devices

Depending on the status of a device, the color of the tile changes:

Active (Green) 	Device is active and working properly.
Unresponsive (Yellow) 	Device is unresponsive.

Error detected (Red) 	Device has encountered an error. The status and information of the device can't be updated by PowerStream Plus. To fix this, try rebooting your device.
Detected (Light grey) 	Device is present on the network but not initialized. When a device is present on the network, the IP address appears on the tile.
Lost (Dark grey) 	Device was once detected, but can no longer be detected by PowerStream Plus. When a device is no longer detected, the tile lists the last known IP address of that device.
Undetected (Black) 	Device can't be detected by PowerStream Plus. When a device is no longer detected, the tile lists the last known IP address of that device. To remove the tile of a device that's no longer needed, select the tile and click the Delete (✕) icon.

Depending on the write accesses to a device, the color of the tile border changes.

View only (Red border) 	Device can be accessed, and the settings of the device can be viewed but not modified. To modify the settings, you need a valid password and user name, depending on your Maevex product. Maevex 5100 Series devices must all use the same password. Maevex 6100 Series devices must be configured with your user name and password. For more information, see “4 - Managing users and passwords”, page 23.
Unknown (Grey border) 	Device can be accessed but no password was created. You're prompted for a password when you click Apply . Once a password is provided, the status becomes View only or Modify settings .
Modify settings (Black border) 	Device can be accessed and the settings can be modified. A valid password is provided.

3 Adding devices to your environment

PowerStream Plus automatically detects and adds new devices to your Maevox environment. If devices aren't detected, PowerStream Plus can scan one or more specific IP addresses or a range of IP addresses for Maevox devices.

3.1 Network discovery



Note: When the IP address or the method of assigning an IP address to an encoder or a decoder changes, you need to reboot the device for the changes to take effect.

3.1.1 Dynamic IP addressing

PowerStream Plus automatically detects all the Maevox products in the same subnet as your controller system through the UPnP (Universal Plug and Play) protocol.

3.1.2 Static IP addressing

Once PowerStream Plus has detected an encoder or a decoder, you can manually assign a static IP address to your device through the **Network** settings of your Maevox product.

For more information on assigning a static IP address, contact your network administrator.

3.2 Manual device discovery

If PowerStream Plus doesn't automatically detect the encoders and decoders on the same subnet as your controller system, you can add them manually.

3.2.1 Scanning one or more IP addresses

- 1 From the PowerStream Plus menu, select **Manual device discovery**.
- 2 Select **Scan a list of IP addresses**, and then select the IP version to scan (**IPv4** or **IPv6**).
- 3 Enter the **IP address** of the device you want to add.
- 4 Click **Add to scan list**.
- 5 Repeat steps 3 and 4 for all the addresses you want to add to the list.
- 6 When you're done, click **Scan list**.

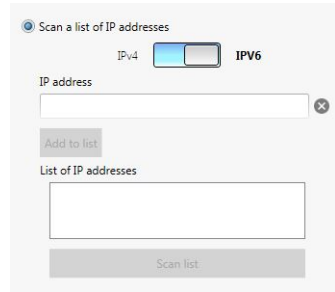

If a new device is found at an IP address provided, that device is added to the **New devices** group.

3.2.2 Scanning a range of IP addresses (IPv4 only)



Note: This option is supported only with IPv4.

- 1 From the PowerStream Plus menu, select **Manual device discovery**.
- 2 Select **Scan a range of IP addresses (IPv4 only)**.
- 3 Enter the starting and ending IP addresses of the range you want to scan.
- 4 Enter the subnet mask to use when scanning for IP addresses. For more information on the subnet mask to use, contact your network administrator.
- 5 Click **Scan range**. If the starting or ending addresses are invalid, the **Scan range** button is disabled.

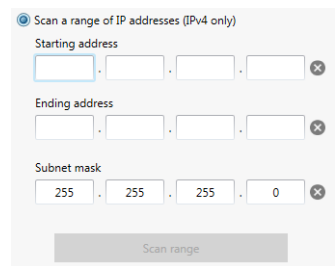

If a new device is found, that device is added to the **New devices** group.

3.3 Administrative control on a Maevox 6100 Series device

When a new Maevox 6100 Series device is added to a network environment for the first time (or a factory reset is done), there is no ownership (administrator) associated with it. A user needs to take administrative control over this device. Only administrators will be able to edit PowerStream Plus settings.

A device without ownership continuously broadcasts its presence on the network and appears in the **Manage users** screen. The *first* user who logs into PowerStream Plus and adds the device from the **Manage users** screen becomes the administrator of that device until a factory reset is done. **Note:** We recommend that a *Maevox environment administrator* takes administrative control of this Maevox device.

For more information, see [“4.4.8.1 - Assign the Maevox environment administrator”](#), page 34 and see [“4.4.8.2 - Adding yourself as a device administrator”](#), page 34.

4 Managing users and passwords

In a Maevox environment, your Matrox PowerStream Plus software, Maevox encoder, and Maevox decoder use passwords for secure communication.

4.1 Environment password

A Maevox environment has a *single password* that allows PowerStream Plus to access the encoders and decoders in that environment.

When you start PowerStream Plus for the first time, you need to provide the environment password.

- In a *new environment*, the environment password is used for all the encoders and decoders detected by PowerStream Plus.
- In an *established environment*, use the password already entered for that environment.



Note: When you log in to PowerStream Plus, a Maevox environment is created uniquely for you using your user login credentials (user name and password). You will be able to see the devices that are registered to the same user name and password, with a black border around the device tile.

4.2 Device password

Each device has a unique password. When a new encoder or decoder is added to the Maevox environment, the device password needs to be updated to match the Maevox environment password.



Note: If the Maevox environment password doesn't match a device password, that device is listed as **View only**. Also, you won't be able to access the settings of that device.

4.3 Maevox 5100 Series



Note: Maevox 5100 Series – Passwords are case-sensitive and can be between 6 and 8 alphanumeric characters long.

To manage your Maevox 5150 encoder and decoder, PowerStream Plus uses two types of passwords: “Environment password” and “Device password”.

4.3.1 Changing your environment password

If an encoder or a decoder in your environment is listed as **View only** (), you need to update the device password to the environment password.

If all the encoders and decoders in your environment are listed as **View only**, you need to change your environment password. To change the password *for all of your devices* by carrying out a single task of changing the environment password, from the main menu, select **Change password**.

For *active* encoders and decoders, changing the environment password also updates the device password to the new environment password.

To change the password *for a single encoder or decoder* in your environment that is listed as **View only**, see “4.3.2 - Changing your Maevox 5100 Series device password”, page 24 below.

4.3.2 Changing your Maevox 5100 Series device password

If the status of a device is **View only**, you can update its password to match your environment password.

To set a password for a device that doesn't have a password (for example, a new device or a device that has been reset to its factory default):

- 1 Select the device tile and click the () icon on the right upper corner of the tile. The **Password Update** screen displays with the message “This device doesn't have a password. Would you like to update it with the currently saved one?”.

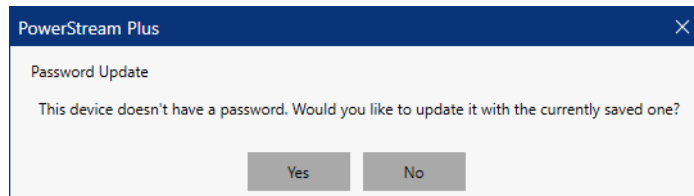

- 2 Click **Yes**.

Your environment password is now set as the device password.

To change the password for a device that already has a password (for example, when you want to take ownership of a device that was previously under someone else's ownership):

- 1 Select the device tile and click the () icon on the right upper corner of the tile.

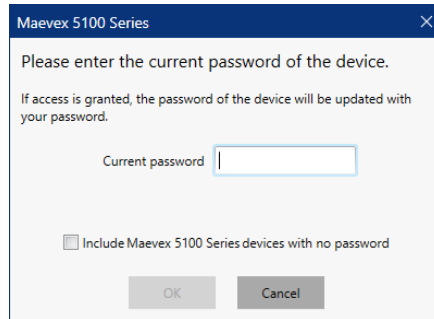

- 2 Enter the existing password for the device in the **Current password** field and click **OK**.

The device password is updated with your environment password.

Note: If you had selected the **Include Maevox 5100 Series devices with no password** option, new or factory reset Maevox 5100 Series devices that did not have a password will now have your environment password assigned to them.

After the device password is changed, the status of the device is updated to **Modify settings**. For more information, see “2.8 - Understanding the status of your devices”, page 18.

4.4 Maevox 6100 Series

The password structure, user types, log in, and credential management for Maevox 6100 Series differ from the Maevox 5100 Series.

4.4.1 Passwords



Note: Maevox 6100 Series – Passwords are case-sensitive and must be between six (6) and sixty four (64) alphanumeric characters long for local users. For domain users, the password length and restrictions will depend on the requirements set by the domain administrator (for example, your IT department).



Note: To obtain a user name and device password (or if you've forgotten your user name or device password) contact your *Maevox environment administrator*.

4.4.2 User types and permissions

A *Maevox environment administrator* can set administrator rights for oneself on the devices, create users on these devices, and set permission for these users. For more information, see “4.4.8.1 - Assign the Maevox environment administrator”, page 34 and see “4.4.8.2 - Adding yourself as a device administrator”, page 34.

Users can be granted administrator rights (with a superset of permissions), or permission to do a specific task only (such as edit users, make and apply settings changes, or reboot devices), or permission to do a combination of these tasks.

A user who has been granted administrator rights would in turn be able to add or remove other users and assign the users to devices. For more information, see “4.4.8.3 - Adding users to a device”, page 35.

4.4.3 Credential management systems

Maevox 6100 Series offers two types of credential management systems that protect the devices from unauthorized use. The first system is tied to Microsoft Active Directory which ensures that the user names and passwords are managed by network IT administrators and comply with the IT department’s credential policy. Matrox strongly recommends using this option when possible.



Note: If you plan to log in using the **Domain user Active Directory** option in your Maevox environment, we recommend assigning your domain user name and making sure you have administrator permission for your Maevox device(s).

When Microsoft Active Directory is not available, a native credential management system is used by Maevox 6100 Series.

To access or modify the settings of your Maevox 6152, 6122, or 6100 device, you need to define a user name for a device, and the device password for that user *must match* the password used in PowerStream Plus. Your *Maevox environment administrator* creates an environment password and assigns that password to the Maevox 6152, 6122, or 6100 devices. The *Maevox environment administrator* can then add users to a device and give them permissions for a given device.

4.4.4 User log-ins

Maevox 6100 Series supports two types of user log-ins: **Local user** and **Domain user Active Directory** (in PowerStream Plus releases prior to v3.01, this is labeled as **Domain user**). When logging in as a local user, the Maevox native credential management system is used for authentication. When logging in as a domain user, Microsoft Active Directory Domain Services is used for authentication.

Once you log in either as **Local user** or **Domain user Active Directory**, all Maevox devices that have user or administrator rights to your specific login credentials will become accessible (unless you have permission only to reboot device or edit user in which case you will see the device tile with red border to indicate view only mode). It will be possible for you to detect and view all Maevox devices within your network; however, you will have access only to the devices associated with your log-in credentials.

For more information, see “4.4.5 - Adding local users”, page 27 and see “4.4.6 - Adding domain users”, page 27.

For details on how to log in, see “4.4.7.1 - Log in as a local user”, page 28 and see “4.4.7.2 - Log in as a domain user”, page 32.

4.4.5 Adding local users

For devices that have an administrator or owner, *local users* are defined by the *Maevox administrator* and managed through PowerStream Plus. For devices that do not have an administrator or owner, you can create your own credentials and include yourself as a *local user*.

To obtain a local user name and device password if you are a *local user* without administrative control on a device (or if you’ve forgotten your user name or device password), contact your *Maevox administrator*. To change your current password, see “4.4.7 - Logging in and out”, page 27.

For more information, see “4.4.7.1 - Log in as a local user”, page 28.

4.4.6 Adding domain users

Domain users are defined by your *network administrator* and managed through an *Active Directory*® network. Maevox software and hardware use *Active Directory* to authenticate the user name and password of domain users.

For devices that have an administrator or owner, *domain users* are defined by the *Maevox administrator* and managed through PowerStream Plus.

PowerStream Plus supports *user groups*. Instead of specifying *domain users* individually, an existing *Active Directory user group* can be specified as *domain users* for easy set up.

A domain user who is also part of a user group is granted the highest privilege available (as a user group member or as an individual user). For more information, contact your *network administrator*.

To obtain a user name and password for a domain user (or if you’ve forgotten your domain user name or password), contact your *network administrator*.

For more information, see “4.4.7.2 - Log in as a domain user”, page 32.

4.4.7 Logging in and out

To modify the settings of your Maevox 6100 Series device, you need to log into PowerStream Plus. You can log in either as a local user or a domain user.

4.4.7.1 Log in as a local user

To log in as a local user:

- 1 From the PowerStream Plus main menu, click **Log in**. The **Log in** screen displays.

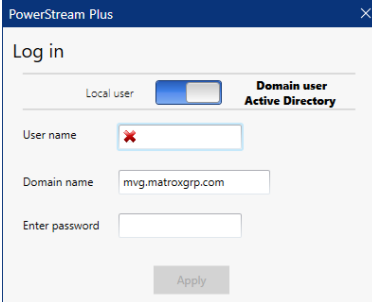

PowerStream Plus

Log in

Local user Domain user Active Directory

User name

Domain name

Enter password

Apply

- 2 Select **Local user** if it doesn't default to this option.

The **Credential Information** pop-up screen displays with the reminder message that the user name and the device password you enter will be used to authenticate against the credentials stored in the MaeveX 6100 Series device(s), and the authorized device(s) will be shown as active and accessible.

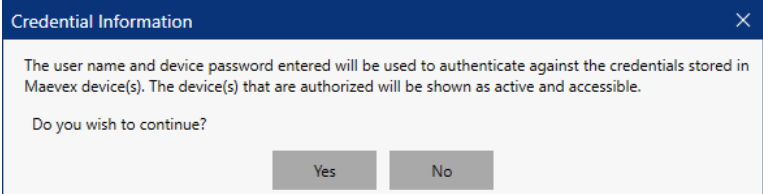

Credential Information

The user name and device password entered will be used to authenticate against the credentials stored in MaeveX device(s). The device(s) that are authorized will be shown as active and accessible.

Do you wish to continue?

Yes No

- 3 Click **Yes**. The **Log in** screen displays.

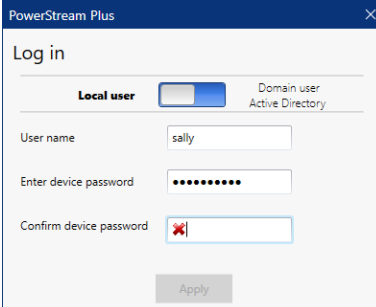

PowerStream Plus

Log in

Local user Domain user Active Directory

User name

Enter device password

Confirm device password

Apply

- 4 Enter your user name in the **User name** field, the password in the **Enter device password** field, reenter the password in the **Confirm device password** field, then click **Apply**.

The **Password Information** pop-up screen displays with the message that if the password you entered does not match your current device password stored on the Maevox device(s), the device(s) will be in **View-only** mode.

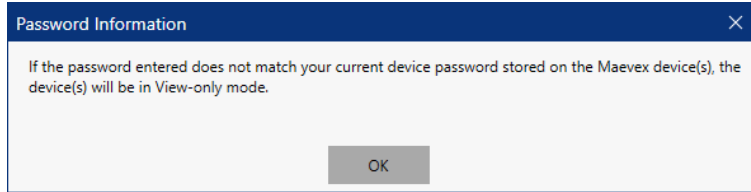

- 5 Click **OK**.

All Maevox devices that have user or administrator rights to your login credentials will now become accessible.

For more information on the definition of a local user, see [“4.4.5 - Adding local users”](#), page 27.

4.4.7.1.1 Changing your Maevox 6100 Series password



Note: Passwords are case-sensitive and must be between six 6 and sixty four (64) alphanumeric characters long.



Note: Only a local user will be able to change the device password.

To update all devices under a local user's ownership (change the environment password):

- 1 When logged in as a *local user*, from the PowerStream Plus main menu, click **Change password**. (The **Change password** option is not available when you are logged in as a domain user.) The **Change your password** screen displays.

PowerStream Plus

Change your password

All Maevox 6100 Series active devices will be affected.

If your user name isn't part of the list of users who have access to that device, that device will be listed as **View only**. If you still can't access the device after you change your password, contact your Maevox administrator to request access to that device.

User name

Current device password

Enter device password

Confirm device password



- 2 Enter the password that is stored in the Maevox device for your user name in the **Current device password** field.
- 3 Enter the environment password in the **Enter device password** field, and reenter it in the **Confirm device password** field.
- 4 Click **Change**.

This updates the passwords for all the devices that are under your ownership.

After the device password is changed, the status of the device is updated to **Modify settings** (the device tile has a black border). For more information, see [“2.8 - Understanding the status of your devices”](#), page 18.

To change the device password, from the device tile, when logged in as a local user, see [“4.4.7.1.2 - Change a single device password to match the environment password”](#), page 31.

4.4.7.1.2 Change a single device password to match the environment password

If the status of a device is **View only** (the device tile has a red border), you need to change the device password to match the environment password. When a MaeveX 6100 Series device in your environment is in **View-only** () mode, an icon () option to change the device password displays on the top right corner of the device tile.

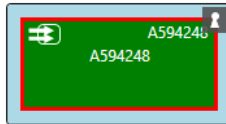

Note: This icon will display only when you are logged in as a local user and not when you log in as a domain user. Also, your user name must match the user name currently on the device. You need to use this icon to update the device's current password to the environment password to be able to access the device.

- 1 When logged in as a *local user*, click the change password icon () from the device tile. The **Enter the current device password for this device** screen displays. The **User name** field displays your user name and cannot be changed.

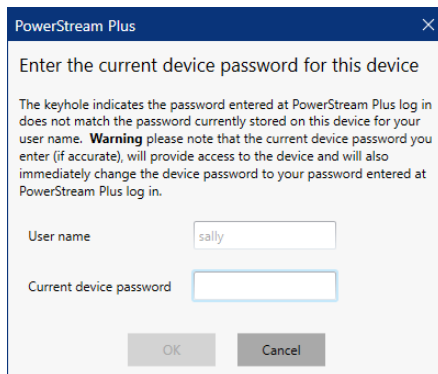
A screenshot of a dialog box titled "PowerStream Plus" with a close button (X) in the top right corner. The main heading is "Enter the current device password for this device". Below the heading is a warning message: "The keyhole indicates the password entered at PowerStream Plus log in does not match the password currently stored on this device for your user name. **Warning** please note that the current device password you enter (if accurate), will provide access to the device and will also immediately change the device password to your password entered at PowerStream Plus log in." There are two input fields: "User name" with the value "sally" and "Current device password" which is empty. At the bottom are "OK" and "Cancel" buttons.

- 2 Enter the password that is stored in the MaeveX device for your user name in the **Current device password** field.



Note: When you enter the correct current device password, the password stored in the device will be updated to your PowerStream Plus local user log in password.

Note: Passwords cannot be retrieved (either for a local or domain user). Therefore, Matrox recommends noting down your passwords (current device as well as the PowerStream Plus log in) before applying the password change.

3 Click **OK** to apply the change.

Note: When you apply the change, the device password gets overwritten *immediately* with your PowerStream Plus local user log in password.

After the device password is changed, the status of the device is updated to **Modify settings**. For more information, see “2.8 - Understanding the status of your devices”, page 18.

4.4.7.2 Log in as a domain user

To log in as a domain user:

- 1 From the PowerStream Plus main menu, click **Log in**. The **Log in** screen displays. The **Domain user Active Directory** option is selected by default.

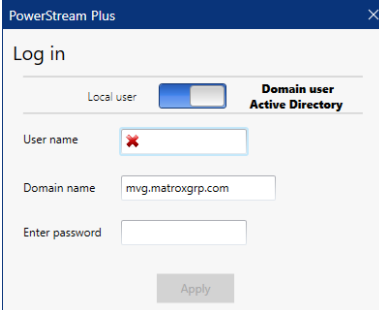

- 2 Enter your user name, the domain name of the server, and your network password.
- 3 When you're done, click **Apply**.

The credentials you provided are authenticated against a server running Active Directory Domain Service. If the credentials are valid, the Maevox device(s) with the appropriate stored domain user name will be listed as **Active** (under **Filter by status**) and accessible

(**Modify settings** under **Filter by permissions** will display the number of devices). If the credentials are invalid, an error message displays.

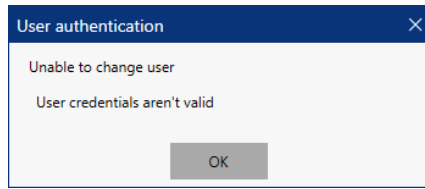

For more information on the definition of a domain user, see “4.4.6 - Adding domain users”, page 27.

4.4.7.3 Log out

To log out, click **Log out** from the main menu of PowerStream Plus. A confirmation message “You have logged out successfully” displays briefly.

4.4.8 Managing your Maevox 6100 Series users

Select the devices on which you want administrator rights.



Add or remove users and edit their permissions.

	BR99430 BR99430	BR69686 BR69686	BR58719 BR58719	
swilson				
gwhitmore				
mtreemblay				
gpatriano				
dkowalsky				
fleclerc				
pcheckov				

Permissions

- Administrator
- Apply changes
- Edit users
- Reboot device

Add user
Delete user

Overwrite the existing password of the selected users. Overwrite password

4.4.8.1 Assign the Maevox environment administrator

When installing PowerStream Plus for the first time, you will be prompted to confirm if you are a *Maevox environment administrator*.

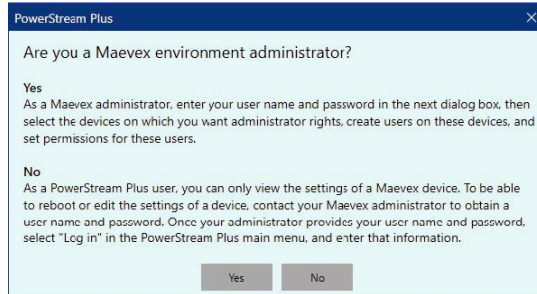

In this screen, select **Yes**, then enter your user name and password. When you are logged in as a *Maevox environment administrator*, you can set administrator rights for yourself on the devices, create users on these devices, and set permission for these users. The devices for which you can modify the settings display with a black border around the device tile.

4.4.8.2 Adding yourself as a device administrator

When a new Maevox 6100 Series device is added to a network environment for the first time, there is no administrator associated to it.

To add yourself as an administrator to take administrative control of a Maevox device:

- 1 Click **Manage users** from the PowerStream Plus main menu. A screen appears with a table displaying the devices for which you have permissions (Administrative and/or User permission) in the columns.

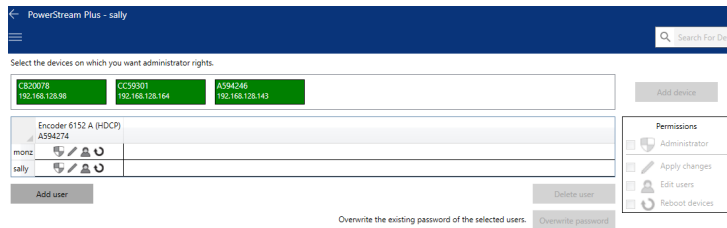

- 2 Select the device to which you would like to add yourself as an administrator by clicking on the device tile under the **Select the devices on which you want administrator rights** section. **Note:** Select multiple devices (by using the **Ctrl** key) if you need to set yourself as the administrator on multiple devices. The **Add device** button gets enabled.

- When you're done, click **Add device**. The screen displays with the selected devices in columns in the table.

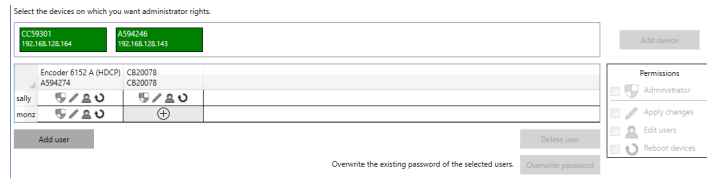

You will now have administrative control on all the devices you have added. You can verify this by going to the PowerStream Plus main page where you will see the devices for which you can modify the settings displayed with a black border around the device tiles.

Note: You can choose to continue by adding all the users for the device now or add them later.

- Click **Add user** to assign a new user to the Maevex device(s) along with the appropriate permissions. Repeat until you have added all the required users.

4.4.8.3 Adding users to a device

A Maevex environment administrator or Maevex administrator can add users to a device.

To add a user to a device:

- Click **Manage users** from the PowerStream Plus main menu. A screen appears with a table displaying the devices for which you have permissions (Administrative and/or User permission) in the columns.

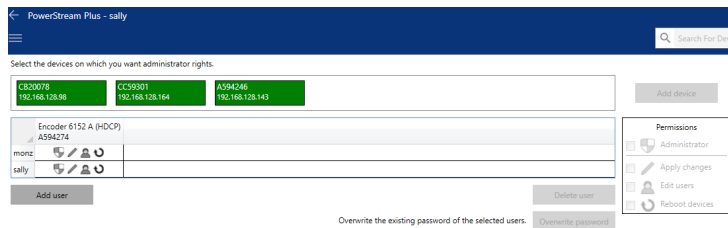

- 2 Click **Add user**, then enter a user name. Specify if you're adding a **Local user** or a **Domain user/active directory**.

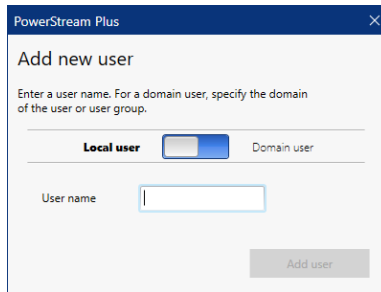

- 3 When you're done, click **OK**. The user gets added on a new row.
- 4 Click the **Add** (⊕) icon for each device you want to add the user to, then select the permissions (by clicking the check box beside **Administrator**, **Apply changes**, **Edit users**, and **Reboot devices** under **Permissions**) for the user.
- 5 Repeat steps 2 to 4 for each user you want to add.
- 6 When you're done, click **Apply**. This creates a **Summary of the users created** and for each local user, a device password is generated.
- 7 To close the dialog box, click **OK**.

4.4.8.4 Deleting users

To delete a user from a device:

- 1 Click **Manage users** from the PowerStream Plus main menu. A screen appears with a table displaying the devices for which you have permissions (Administrative and/or User permission) in the columns.
- 2 Select the user you want to delete, then click **Delete user**.
- 3 When you're done, click **Apply**.

4.4.8.5 Overwriting a password

To overwrite the existing password of a local user:

- 1 Select the user whose password you want to overwrite, then click **Overwrite password**.
- 2 Enter the new password, confirm the password entered, then click **Change**. (We recommend you take note of the new password.) A confirmation screen displays if the password overwrite is successful or not.

4.5 Maevox 7112 encoders

To modify the settings of your Maevox 7100 Series device, you need to log into PowerStream Plus. You can log in either as a local user or a domain user.

4.5.1 Passwords



Note: Passwords are case-sensitive and must be between six (6) and fifteen (15) alphanumeric characters long for local users. For domain users, the password length and restrictions will depend on the requirements set by the domain administrator (for example, your IT department).



Note: To obtain a user name and device password (or if you've forgotten your user name or device password) contact your *Maevox environment administrator*.

4.5.1.1 Log in as a local user

To log in as a local user:

- 1 From the PowerStream Plus main menu, click **Log in**. The **Log in** screen displays.

The screenshot shows a 'Log in' dialog box with the following elements:

- Title bar: PowerStream Plus
- Section: Log in
- Radio buttons: Local user (selected), Domain user Active Directory
- User name field: Contains a red 'X' error icon.
- Domain name field: Contains 'mvg.matroxgrp.com'.
- Enter password field: Empty.
- Apply button: Located at the bottom.

- 2 Select **Local user** if it doesn't default to this option.

The **Credential Information** pop-up screen displays with the reminder message that the user name and the device password you enter will be used to authenticate against the

credentials stored in the Maevox 7100 Series device(s), and the authorized device(s) will be shown as active and accessible.

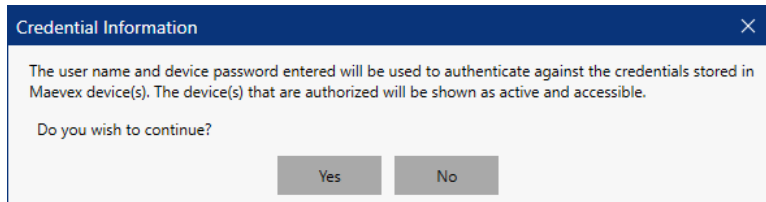

Note: PowerStream Plus also automatically detects and allows full control of all Maevox 7100 Series devices with factory default credentials (new devices or devices that have been reset to their factory default configuration).

- 3 Click **Yes**. The **Log in** screen displays.

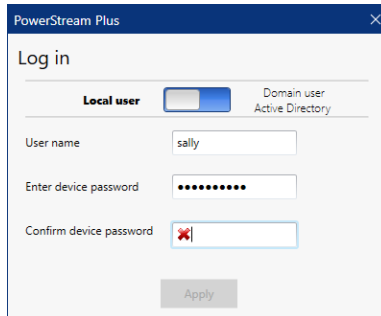

- 4 Enter your user name in the **User name** field, the password in the **Enter device password** field, reenter the password in the **Confirm device password** field, then click **Apply**.
- 5 Click **OK** in the pop-up screen that displays.

All Maevox 7100 devices whose local user credentials match your PowerStream Plus user credentials, as well as all devices with factory default credentials (new devices or devices reset to their factory default configuration) will now become accessible for you to control.

The default local user name of such devices is **admin** and the password is **123456**. These credentials can be modified from within the PowerStream Plus software, or through the device WebUI directly.



Note: While you are in the local user mode, to alternate between controlling a device from the PowerStream Plus software and directly through its WebUI, you *must* use the same local user device credentials.

4.5.1.2 Log in as a domain user

To log in as a domain user:

- 1 From the PowerStream Plus main menu, click **Log in**. The **Log in** screen displays. The **Domain user Active Directory** option is selected by default.

PowerStream Plus

Log in

Local user Domain user **Active Directory**

User name

Domain name

Enter password

Apply

- 2 Enter your user name, the domain name of the server, and your network password.
- 3 When you're done, click **Apply**.

The credentials you provided are authenticated against a server running Active Directory Domain Service. If the credentials are valid, the Maevox device(s) with the appropriate stored domain user name will be listed as **Active** (under **Filter by status**) and accessible (**Modify settings** under **Filter by permissions** will display the number of devices). If the credentials are invalid, an error message displays.

User authentication

Unable to change user

User credentials aren't valid

OK

5 Processing overview

This section provides an overview of the encoding and decoding processes.

5.1 Encoding process overview

Maevox 6100 Series only – The following outlines the encoding process of your Maevox 6100 Series encoder.



1	Inputs	Enable the input signal to be captured and used as a source.
2	Processing	Specify one or more inputs as a source that are encoded to output a stream or record a file. You can add or remove processes. An encoder must have at least one process.
3	Sources	Add one or more sources to be able to generate an encoding.
4	Encoding	Define how the source is encoded to create a stream or a recording. By default, an encoding is created to use one stream. You can add or remove encoding processes.
5	Stream	Configure the settings of a stream. An encoding must have at least one stream. You can add or remove streams with different protocols. Only one stream with a particular protocol is supported for each encoding. To have multiple streams with the same protocol, the streams must be the output of separate encodings. These encodings may be generated from the same processing.
6	Recording	Enable recording and specify a recording location (such as to a Network Attached Storage (NAS) device or a network shared folder). You can add or remove recordings.

5.2 Decoding process overview

Maevox 6152 decoder only – The following outlines the decoding process of your Maevox 6152 quad-output 4K decoder appliance.

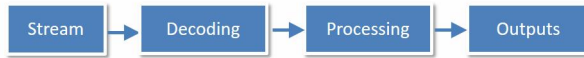

1	Stream	<p>You need to configure the video and audio streams that have to be decoded. For decoding, you must have at least one stream for each output.</p> <p>Note: Video and audio streams from connected encoders are automatically detected by PowerStream Plus and appear in the Streams list in the Decoding page. You can also add streams manually to the stream list.</p>
2	Decoding	<p>Define how the streams have to be decoded to create the outputs. For this, you have to first select a layout (made up of single or multiple panels) and its settings including resolution and pixel format from the Layout page. Then, from the Decoding page add a stream to each panel of the layout. Streams with different protocol and format can be added in a layout.</p> <p>Note: 4Kp60 in YUV 4:4:4 pixel format can only be transferred to HDMI Outputs 1 and 3 (HDMI Outputs 2 and 4 remain unused in this case).</p> <p>Note: It is highly recommended to maintain the processing power under 100% at all times. The Video decoding percentage is displayed in the Telemetry section of the Information dashboard. For example, selecting 2x2 panel layouts on all four outputs could push the processing to over its maximum.</p>

3	Processing	<p>Based on the settings selected, PowerStream Plus either matches the stream resolution with the display resolution or converts resolution according to settings, selects the output pixel format depending on the pixel format of the streams or a user-set pixel format, composites multiple streams, scales, optimizes performance when two or more outputs have the same configuration, synchronizes streams, and carries out other processing tasks.</p> <p>Note: It is highly recommended to maintain the processing power under 100% at all times. The Video processing percentage is displayed in the Telemetry section of the Information dashboard. Do not overload the processing capacity of the device when decoding, compositing, scaling, or otherwise transforming multiple streams.</p>
4	Outputs	<p>Outputs are displayed on the monitors based on the set layout, resolution, refresh rate, pixel format, scaling, and background color.</p>

6 Maevox 7112 encoder settings

This enables you to view, configure, and manage settings specific to a Maevox 7112 encoder.

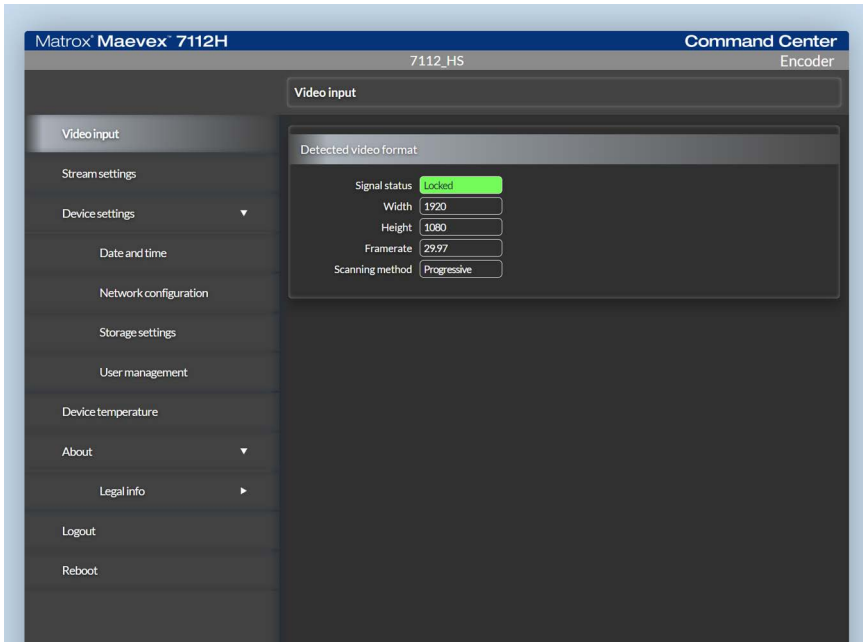

Note: Don't change the input or network connections while your Maevox device is turned on. If connections are changed while your Maevox device is turned on, your video sources or recordings will be lost.



Note: You can also access the device settings directly from a web browser (by entering the IP address of the Maevox 7112 device on a web browser) instead of using the Matrox PowerStream Plus software. You will see the same user interface and settings pages whether you access the device settings from the web browser or from the PowerStream Plus software.



Note: If necessary, you can use the Matrox Maevox Firmware Updater application to detect the Maevox 7112 devices and identify their IP addresses.

6.1 Video input

Provides information about the video input format and settings.

You can view the following information for your video input.

Detected video format	
Signal status	If the encoder detects a supported video standard, Locked appears against a green backdrop. If the encoder does not detect a supported video standard, Not Locked appears against a red backdrop.
Width	The width of the image in pixels.
Height	The height of the image in pixels.
Frame rate	The image frame rate, in frames per second (fps).
Scanning method	Method of scanning for displaying video frames. Progressive: A scanning method where the entire image is captured in each frame. Note: Interlaced modes and input capture and encoding are not supported.

6.2 Stream settings

This is used to configure the audio and video encoding parameters.

Video encoder settings	
Compression	Video compression scheme: AVC (H.264) or HEVC* (H.265).
Scaling	Off (default setting) - The resolution of the encoded video mirrors the input resolution, matching the video source. On - Results in the encoding resolution being a scaled (increased or decreased) version of the input resolution. Fields for Scaled width and Scaled height become visible. Note: In order to make sure that the input video does not get distorted, the aspect ratio between the scaled stream width and height should be kept identical to the detected video input's aspect ratio. (The aspect ratio of a video signal is its width divided by its height.)
Scaled width	The required encoding resolution width, for example 1280.
Scaled height	The required encoding resolution height, for example 720.
Frame rate	The ratio of the target (encoded) frame rate to the input frame rate. Full - All frames are encoded. 1/2 - Every second frame is encoded. 1/4 - Every fourth frame is encoded.

Pixel depth	<p>The number of bits used to specify each color component (Y, U, V) of a pixel.</p> <p>8 bits/pixel - Each component is represented using 8 bits.</p>
Color format	<p>The chroma sub-sampling scheme used to compress video transmissions.</p> <p>4:2:0 - The video is compressed using 4:2:0 color space (normal quality).</p>
Encoding latency	<p>Selection of encoding latency for AVC and HEVC modes.</p> <p>Normal - Encodes video with standard latency. Latency can extend up to 1 second, influenced by rate control decisions and GOP structure.</p> <p>In normal latency, neither capture nor encoding uses slice-based image processing.</p> <p>Reduced - Image encoding is done in slices.</p> <p>UltraLow - Achieves ultra-low latency in encoding. The latency approximates 1/4 of the frame duration (for example, with 60 fps where frame duration is 16.67 ms, encoding latency may be around 4-5 ms). In this mode, B frames are not used and “Low Latency CBR” is activated.</p> <p>Note: Ultra low-latency encoding requires the use of RTP streaming protocol as well as unencoded LPCM audio or the Opus audio codec.</p> <p>In ultra low latency, both image capture and encoding are done in slices instead of full frames at a time.</p>
Rate control	<p>Algorithm used by the encoder for managing the target bit rate.</p> <p>CBR (Constant Bit Rate) - Utilizes a consistent bit rate for video encoding. Choosing CBR reveals the Max pic size field in the Advanced encoder settings section for value entry.</p> <p>Low Latency CBR - Operates similarly to CBR, but rate control decisions are made in real-time, aiming to keep the frame sizes uniform across all pictures.</p> <p>VBR (Variable Bit Rate) - In VBR, the encoder encodes the video at a variable bit rate. When you select VBR, the Target bit rate and the Maximum bit rate fields display. Also, the Max pic size field displays under the Advanced encoder settings section where you can enter a value.</p>
Target bit rate	<p>The target output bit rate. This influences the advanced encoder preset configuration settings. During encoding, many internal state variables are updated to achieve this target bit rate.</p> <p>Note: This is applicable for VBR only.</p>
Maximum bit rate	<p>The maximum bit rate is always 60 Mbps.</p> <p>Note: This is applicable for VBR only.</p>

Bit rate	Average video output bit rate. A higher bit rate yields a better-quality video. The video input standard influences the minimum bit rate supported. Also, the frame rate and scaling setting used impact the minimum bit rate proportionately. For instance, a reduction of 40% in the frame rate will lead to a reduction of 40% in the bit rate.
Intra refresh mode	<p>Full frame - When selected, at each I/IDR period, an entire frame is encoded as an I/IDR frame, resulting in a frame of relatively large size.</p> <p>GDR-Vertical - Selecting this option leads to frames being perpetually refreshed using vertical stripes of Intra blocks, which helps in reducing high peaks in encoded frame sizes.</p> <p>GDR-Horizontal - Upon selection, frames are consistently refreshed with horizontal stripes of Intra blocks, effectively minimizing high peaks in encoded frame sizes.</p>
GOP length	<p>Full frame - Determines the frequency (in frames) at which the encoder creates an I/IDR (Intra/Instantaneous Decodable Refresh) frame. For instance, a value of 30 means an I/IDR frame is generated every 30 frames.</p> <p>GDR-Vertical and GDR-Horizontal - Specifies the refresh rate of Intra blocks. For GDR-Vertical, as an example, the minimum recommended value for 3840 x 2160 encoding is 135 (calculated as 2160/16).</p> <p>Note: The GOP length should be chosen depending on the specific application and network conditions. In applications requiring higher compression for lower bit rate transmissions, a higher interval value is advisable to help the encoder lower the data traffic by relying more on the much smaller size P (Predictive) frames.</p> <ul style="list-style-type: none"> ▪ Minimum value – 1 frame. ▪ Maximum value – 1000 frames. ▪ Recommended values – 30 to 120 frames.
GOP structure	<p>The Group of Pictures (GOP) structure used. The structure determines whether an I-frame is followed by P-frames (Predictive coded picture) or B-frames (Bi-predictive coded picture).</p> <ul style="list-style-type: none"> ▪ IPPP – Only P frame is used. ▪ IBP, IBBP, IBBBP, IBBBBP – B and P frames are used.

Advanced encoder settings	
CPB [ms]	<p>Defines the size of the coded picture buffer (CPB) in milliseconds, as outlined in the HRD (Hypothetical Reference Decoder) model.</p> <p>Note: The buffering latency on the decoder side needs to match the specified CPB size. Opting for larger CPB values enhances picture quality but results in greater latency. Internally, the encoder will automatically set the initial delay to half of the CPB value.</p>
Min-Q	<p>Sets the minimum value for Q, a parameter used in the encoding process for quantizing DCT/DST coefficients. Q fluctuates between Min-Q and Max-Q, allowing dynamic adjustment of the current bit rate. Both Min-Q and Max-Q values have a direct impact on the bit rate of the encoded stream.</p> <p>The suggested range for Min-Q is between 2 to 5. Opting for higher Min-Q values can lead to a reduction in picture quality.</p>
Max-Q	<p>Sets the maximum value for Q, which is integral to the encoding process for quantizing DCT/DST coefficients. The advised range for Max-Q is between 40 to 51. Selecting lower values for Max-Q enhances the picture quality.</p>
Max pic size [Kbit]	<p>In CBR (Constant Bit Rate) mode exclusively, this setting restricts the maximum size of each encoded frame. The allowable range for values is 2 to 5000. Setting this value to 0 disables the option.</p> <p>The following are the recommended values:</p> <p>Max pic size formula = (Bitrate [Kbits])/FPS * Overhead Overhead = 1.1 to 6</p> <p>Example Bit rate = 10,000 Kbits Fps = 60 Overhead = 1.5 Max pic size = 10,000/60 * 1.5 = 250 Kbits (per frame)</p>
Default, Weak limit, and Hard limit buttons	<p>The Default, Weak limit, and Hard limit preset buttons can be used to configure your advanced encoder settings. The target bit rate is respected in all three presets.</p> <ul style="list-style-type: none"> ▪ Default – No hard limit on encoded frame size. ▪ Weak limit – Encoded frame size will be slightly limited. ▪ Hard limit – Encoded frame size will be strictly limited.

Audio encoder settings	
Audio source	<p>The interface used to capture the audio signal that is used for encoding and streaming.</p> <p>HDMI - Audio for encoding is taken from HDMI (Embedded audio).</p> <p>Line-in - Audio for encoding is taken from Line-in. Synchronization with the HDMI video will be preserved (as much as the input signals are synchronous at the device's inputs).</p>
Enable audio	If checked, encoded stream will include audio.
Detected FS [Hz]	<p>The audio sampling frequency.</p> <p>For HDMI, the supported and automatically detected audio sampling rates are: 32 Khz, 44.1 Khz, and 48 Khz.</p> <p>For analog Line-in audio, the sampling frequency is 48 Khz.</p>
Bit rate [Kb/s]	<p>Sets the bit rate of the encoded audio. The allowable range for values is 64,000 to 256,000 bps with the default being 80,000 bps. When uncompressed LPCM16 audio compression is used, the audio bit rate is $Fs * 16 * 2$. For instance, when Fs is 48 Khz, the audio bit rate is 1.536 Mbps.</p>
Compression	<p>Sets the audio compression method.</p> <ul style="list-style-type: none"> ▪ AAC-LC, LPCM16 (uncompressed), and Opus. <p>For Low latency encoding, LPCM16 (uncompressed) and Opus are supported.</p> <p>Note: LPCM16 and Opus are not supported by Maevex decoders.</p>

Streaming settings	
Enable streaming	Check to enable streaming. For RTP and TS, streaming starts immediately. To disable streaming, clear the checkbox.
Streaming protocol	<p>Sets the streaming protocol. The following protocols are supported.</p> <ul style="list-style-type: none"> ▪ MPEG-2 TS – MPEG-2 Transport Stream protocol. For more information, see “6.2.2.1 - MPEG-2 TS streaming”, page 50. ▪ MPEG-2 TS (RTP) – MPEG-2 Transport Stream over RTP protocol. For more information, see “6.2.2.2 - MPEG-2 TS [RTP] streaming”, page 51. ▪ RTP – Real-Time Protocol over UDP. For more information, see “6.2.2.3 - RTP streaming”, page 51. ▪ RTSP – Real-Time Streaming Protocol. The Recording settings section displays when RTSP is selected. Recording without RTSP streaming is currently not supported. For more information, see “6.2.2.4 - RTSP streaming”, page 51. ▪ SRT – Secure Reliable Transport streaming protocol. For more information, see “6.2.2.5 - SRT streaming”, page 53. ▪ RTMP / RTMPS – Real-Time Messaging Protocol. For more information, see “6.2.2.6 - RTMP / RTMPS streaming”, page 54. <p>Information on configuring the individual streaming modes are detailed in separate sub-topics under “Streaming protocols”, page 50 .</p>

* HEVC is supported only on the Matrox Maevex 7112H model.

6.2.1 Recommended minimum and maximum bit rates

The minimum bit rates supported by the Maevex 7112 encoder, for popular video standards, are given in the table below.

Note: For **AVC**, you need to add roughly 30-40% to the values in both columns.

Video standard	Typical recommended minimum bit rate (Mbps)	Maximum bit rate (Mbps)
640 x 480p59.84	.5	60
720 x 480p60	.5	60
720 x 576p50	.5	60
1280 x 720p60	.8	60
1920 x 1080p60	1	60
3840 x 2160p60	4	60

The following table lists the recommended video bit rate values for different video standards.

Video resolution	Video quality (Mbps)		
	High	Medium	Low
3840 x 2160@60p	40 - 60	8 - 16	4 - 8
1920 x 1080@60p	10 - 15	2 - 4	1 - 2
720 x 480 @60p	4 - 6	.8 - 1	.4 - .8

6.2.2 Streaming protocols

The MaeveX 7112 encoder supports the following streaming protocols.

- **MPEG-2 TS** – MPEG-2 Transport Stream protocol. For more information, see “6.2.2.1 - MPEG-2 TS streaming”, page 50.
- **MPEG-2 TS [RTP]** – MPEG-2 Transport Stream over RTP protocol. For more information, see “6.2.2.2 - MPEG-2 TS [RTP] streaming”, page 51.
- **RTP** – Real-Time Protocol over UDP (only RTP supports ultra low latency streaming). For more information, see “6.2.2.3 - RTP streaming”, page 51.
- **RTSP** – Real-Time Streaming Protocol. For more information, see “6.2.2.4 - RTSP streaming”, page 51.
- **SRT** – Secure Reliable Transport streaming protocol. For more information, see “6.2.2.5 - SRT streaming”, page 53.
- **RTMP[S]** – Real-Time Messaging Protocol. For more information, see “6.2.2.6 - RTMP / RTMPS streaming”, page 54.

6.2.2.1 MPEG-2 TS streaming

The following fields appear in the **Streaming settings** section when you choose **MPEG-2 TS** streaming.

MPEG-2 TS Streaming settings	
Unicast/Multicast address	The destination IP address of the MPEG-2 TS stream. Note: MPEG-2 TS supports unicast and multicast transmissions. In order to perform a multicast transmission, use a multicast-dedicated IP address.
Base port	The destination video port of the MPEG-2 TS stream.
MPEG-2 TS stream URL	This address is generated automatically by the encoder and should be copied to the video decoder / player.

6.2.2.2 MPEG-2 TS [RTP] streaming

The following fields appear in the **Streaming settings** section when you choose **MPEG-2 TS [RTP]** streaming.

MPEG-2 TS [RTP] Streaming settings	
Unicast/Multicast address	The destination IP address of the MPEG-2 TS [RTP] stream. Note: MPEG-2 TS [RTP] supports unicast and multicast transmissions. In order to perform a multicast transmission, use a multicast-dedicated IP address.
Base port	The destination video port of the MPEG-2 TS [RTP] stream.
MPEG-2 TS [RTP] stream URL	This address is generated automatically by the encoder and should be copied to the video decoder / player.

6.2.2.3 RTP streaming

The following fields appear in the **Streaming settings** section when you choose **RTP** streaming.

RTP Streaming settings	
Video base port	The destination video UDP port of the RTP stream.
Unicast/Multicast address	The destination IP address of the RTP stream. Note: RTP supports unicast and multicast transmissions. For multicast transmission, use an IP address dedicated to multicast.
MTU	Set MTU (Maximum transmission unit) size. Maximum size is 1500.
Download SDP file	The SDP (Session Description Protocol) file is generated automatically by the encoder and contains information about the streaming parameters. The player should open this file to display the stream.



Note: The RTP specification recommends selecting an even RTP port number, and the next higher odd number for an associated RTCP port. The Maevox 7112 encoder supports RTCP packets. An example Video RTP destination port is: 10000 (associated RTCP port numbers would be 10001 and 10002). An example Audio RTP destination port is: 10004 (associated RTCP port numbers would be 10005 and 10006).

6.2.2.4 RTSP streaming

RTSP supports streaming to a single client in unicast, or to multiple clients in multicast. When a RTSP session is active in unicast mode (e.g. a player is receiving a steam from the encoder), other requests to join, will be refused.

In RTSP multicast, many clients can join the same session. The total bit rate produced by the encoder is equal to the bit rate set regardless of the number of clients receiving the stream.

The following fields appear in the **Streaming settings** section when you choose **RTSP** streaming.

RTSP Streaming settings	
RTSP port	The TCP port number of the RTSP session.
RTSP stream name	The name of the RTSP stream.
Multicast streaming	When this option is selected, the encoder will output a single multicast RTP stream which allows several clients to connect to this single stream without the encoder having to replicate the streams. Note: If multicast streaming is disabled, the encoder will send a unicast stream to a single destination.
RTSP stream URL	The URL address is generated automatically by the encoder, and it should be copied to the video decoder or player using the Copy button.
Recording settings	
Enable recording	Enable this to be able to record from your device. The “ <i>Storage/NAS is inaccessible</i> ” message displays.
Save to	The path to the existing network shared folder or the external storage device where your video files will be stored. Select the storage location from the drop down list. For more information, see “6.3.4 - Storage settings”, page 56.
File format	The recording file format is HLS M3U8.
File prefix	Every file name will start with the prefix you enter here followed by an incrementing segment number. For example, if you enter a value of 10 in Segment count , with a Segment duration of 1 minute, and a prefix of “mtx”, this will generate 10 files of 1 minute duration each, and each file name will start with the prefix “mtx- <i>nnn</i> ”, where “ <i>nnn</i> ” is the file number. A file name prefix can be up to 19 characters long.
Segment count	The number of files that will be saved on the storage. Older files will be deleted.
Segment duration [min]	Enter the recording time for each video file recorded. Once the recording time for a file is reached, a new file will be created. A file can hold up to 8 hours of recording. If the sampling rate (audio or video) changes, a new file is created, regardless of the file duration.
Status	Informs the state of the recording when you click the Refresh button. If the recording is normal you will see OK , otherwise, you will see the specific error message. For example, STORAGE_FULL .

6.2.2.5 SRT streaming

Secure Reliable Transport is an open-source video transport protocol. SRT optimizes streaming performance across unpredictable networks, such as the Internet, by dynamically adapting to the real-time network conditions between transport endpoints. This helps minimize effects of jitter and bandwidth changes, while error-correction mechanisms help minimize packet loss. SRT supports end-to-end encryption with AES. When performing retransmissions, SRT only attempts to retransmit packets for a limited amount of time based on the latency as configured by the application.

The following fields appear in the **Streaming settings** section when you choose **SRT** streaming.

SRT Streaming settings	
SRT mode	Caller mode.
Destination URL	The destination URL.
Base port	The destination port.
Latency [ms]	20-2000 ms; should be set to 3xRTT (Round Trip Time).
Encryption	Available values are None , AES128 , AES192 , and AES256 . If you select AES128 , AES192 , or AES256 , enter the passphrase in the Passphrase field.
Passphrase	If Encryption is selected (other than None), enter a passphrase.

SRT Streaming settings	
SRT mode	Listener mode.
Base port	The port that SRT will listen on.
Latency [ms]	20-2000 ms; should be set to 3xRTT (Round Trip Time).
Maximum overhead bandwidth (%)	Sets the maximum overhead bandwidth that is used for recovering lost packets. Supported values are between 5% to 100%, with the default being 5%.
Encryption	None , AES128 , AES192 , and AES256 are the available options. If you select AES128 , AES192 , or AES256 , enter the passphrase in the Passphrase field.
Passphrase	If Encryption is selected (other than None), enter a passphrase.
SRT stream URL	Generated URL of the final stream.



Note: In **Listener mode**, the Maevox 7112 encoder will wait for an incoming connection on the specified **Base port**.

In **Caller mode**, the Maevox 7112 encoder will try to connect to the **Destination URL**.

6.2.2.6 RTMP / RTMPS streaming

The RTMP protocol is mainly used to stream live video to Content Delivery Networks (CDNs) such as YouTube, Facebook, Twitch, Wowza, Boxcast, and other CDNs.

Some CDNs require secured RTMP named as RTMPS. When selecting RTMPS, the Audio/Video will be delivered to the CDN in a secured/encrypted manner.

The Maevox 7112 encoder supports both RTMP and RTMPS (Secured RTMP).

The following fields appear in the **Streaming settings** section when you choose **RTMP[S]** streaming.

RTMP[S] Streaming settings	
Destination location	URL provided by the CDN.
Stream name/key	RTMP key provided by the CDN.
RTMP stream status	Displays OK when there are no issues with the streaming, otherwise displays specific error messages.
Go live	Click to go live. Note: You <i>must</i> apply the changes you made by clicking on the Apply button before you go live.
Stop stream	Click to stop the live stream.



Note: To find out the precise audio and video encoding parameters required or supported by your destination, contact your content delivery network (CDN) provider.

6.3 Device settings

This is used to configure the networking parameters, set the time and date, select the user access (log in) mode, and set network attached storage settings.

6.3.1 Device settings main page

The **Device settings** main page displays the product information and the firmware version. It also allows you to detect the unit easily.

Product information	
Model	The model of the device (Maevox).
Serial number	The serial number of the device.
Firmware information	
Firmware version	The firmware version currently on the device.

Detect unit	
Status LED	To help you visually detect the encoder that is being configured, use the ToggleBlinkState button. The Status LED shifts from steady to blinking or vice versa (blinking to steady).

6.3.2 Date and time

The **Date and time** page is used to set the system date and time – either manually, or automatically by an NTP server.

Time	
System uptime	The total system uptime (in hh:mm) since the most recent reboot.
System time	The current system date and time.
NTP	When selected, the system date and time are synchronized with an NTP server. The NTP server , Time zone , and Daylight saving time fields display when you select the NTP check box.
NTP server	The URL of the NTP server used.
Time zone	Set the encoder's time zone.
Daylight saving time	Select this option to adjust the system date and time automatically for daylight savings.

6.3.3 Network configuration

The **Network configuration** page is used to set the encoder's network parameters.

Device network configuration	
Device name	The name of the encoder device.
IP method	<p>Select the method to be used to set the IP address for the encoder.</p> <ul style="list-style-type: none"> ▪ Static – The IP address is set manually. ▪ DHCP – The IP address is allocated automatically using the DHCP (Dynamic Host Configuration Protocol). <p>Note: When a DHCP server isn't available, the encoder will not be able to get network configurations. In such instances, the encoder's IP address will default to an APIPA address if there is no response after trying to send a DHCP request to the server many times.</p>
IP address	The IP address of the encoder.
Netmask	The subnetwork mask used by the network segment in which the encoder operates.

Default gateway	The IP address of the default gateway that serves as the forwarding host router to other networks when no other router specification matches the destination IP address.
DNS server 1	The IP address or host name of the main DNS server accessed by the encoder.
DNS server 2	The IP address or host name of the secondary DNS server accessed by the encoder.
MAC address	The MAC address of the encoder.
Ignore ICMP echo	If checked, the encoder ignores ICMP Echo (ping) requests. This feature can help prevent Denial of Service (DoS) attacks.
Network diagnostics	
Destination IP / Domain	The IP address or domain name of the ping request destination. Click Send ICMP ping to initiate the request.
Ping results	Displays the results of the ping responses. To delete the results, click Clear .
Send ICMP ping	Click to initiate the request.

6.3.4 Storage settings

The **Storage settings** page is used to configure the network attached storage (NAS) information that is necessary if you intend to use the recording function.

NAS settings	
Configuration	Name that identifies the storage location configuration.
Protocol	The protocol used to access the storage location, such as CIFS.
Network IP	To make sure the network path is properly recognized by your device, we recommend you provide the IP address of the system where the shared folder is located. For more information, contact your network administrator.
Shared directory	The name and path of the shared directory.
User name	The user name to access the shared directory.
Password	The password for the user.
Connection status	This field indicates the status of the connection to the storage, such as Mounted and Not mounted .
Last message	Displays the last connection status message.
Establish connection	Select the checkbox to establish connection and mount the storage.

6.3.5 User management

The **User management** page is used to access the user log-in information

Log in	
Authentication	Local user or Domain user/AD (Active Directory).
Username	The user name.
Password	The user's password.



Note: To reset the user name and password, use **Change password** from the main menu.

6.4 Device temperature

You can see the temperature of the device from this page.

Temperature [°C]	
Device temperature	Displays the current temperature of the hottest internal component within the device.
Max temperature	The maximum supported internal component temperature is 90 degrees centigrade.

6.5 About

The **About** main page displays the website and customer support links.

About	
Website	Takes you to the Matrox Video web site.
Customer support	Takes you to the Matrox Video Contact Support web page.

6.5.1 Legal info

You can get the SLA and OSS information from here.

SLA	
Matrox Software License Agreement	The URL to the Matrox Software License Agreement (video.matrox.com/eula).

OSS	
OSS	Open Source Software is software that is distributed with its source code, making it easy to modify and distribute with its original rights. The Maevox 7112 OSS page provides access to a list of OSS packages used within the package, together with their licensing information. To access the page from the main menu, select About → Legal Info → OSS . Click the OSS link. This will take you to the Matrox Third Party Software Notices & Additional Terms and Conditions web page.

6.6 Logout

Note: The **Logout** button is not effective when used from within the PowerStream Plus software user interface. This is applicable for the Web UI only.

6.7 Reboot

Select **Reboot** to shut down and restart the encoder. A confirmation screen displays. Click **OK** to confirm the reboot. A message box displays about the commencement of the reboot.

During rebooting, the LEDs on the front panel of the encoder are lit and steady, or blinking, depending on the current state of the system.



7 Maevox 6152 decoder settings

This enables you to view, configure, and manage settings specific to a Maevox 6152 decoder.

7.1 Decoding

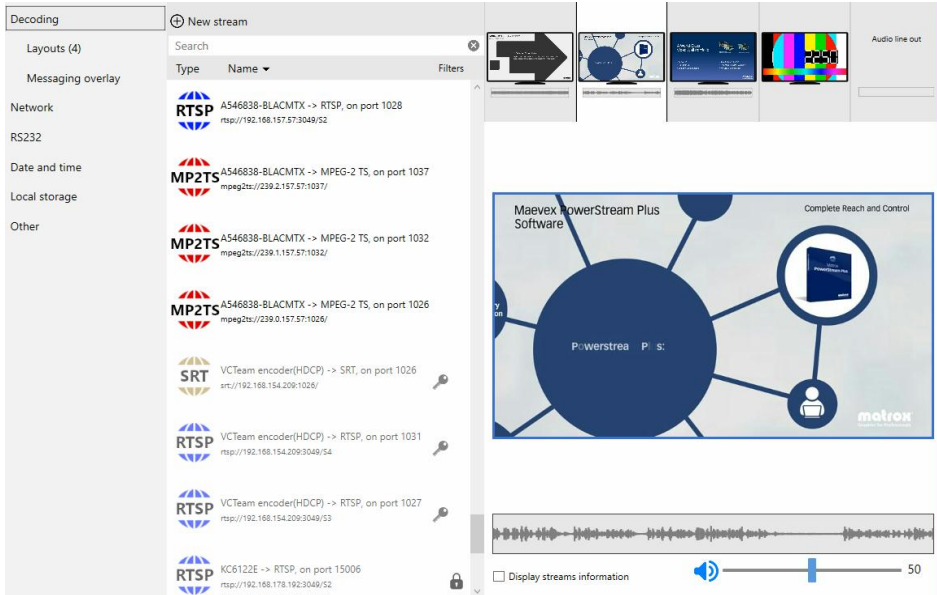
These settings define how the streaming signals are processed by your decoder.



<p>Streams list</p>	<p>Set up your Maevox streams. The list of streams the decoder can decode is on the left of the screen. This is a list from all the encoders discovered by PowerStream Plus automatically as well as manually added streams. Each network protocol icon is in a different color for easy identification. For RTSP streams that require authentication, streams that have been authenticated and usable are identified with a key  icon, but they are greyed out when they are blocked due to not being authenticated. RTSP streams that require authentication have to be added manually (create a custom stream) by entering their details including authentication. For more information, see “7.1.1.1 - Add a RTSP stream”, page 64. Video from a USB is also displayed in the streams list and has the type assigned as USB. You can also upload JPEG and PNG static images from a USB. If a stream has protected content (is HDCP secured), it has a lock sign in the stream list (). If the HDCP secured stream is blocked (this can happen in different scenarios), the stream is greyed out.</p> <p>Note: Non-authenticated HDCP streams can be dragged and dropped into a panel like regular streams, without having to create custom streams for them.</p> <ul style="list-style-type: none"> ▪ Type – You can sort the list by stream type by clicking on the Type column label. The stream types are: RTSP, RTP, MP2TS, SRT, Local storage, and USB. ▪ Name – You can sort the list by stream name by clicking on the Name column label. ▪ New stream – Manually add a stream if you cannot find it in the list. ▪ Search bar – Use the search bar to search on the friendly names in the streams list. ▪ Streams being used (checkbox) – Filter the list to display only the streams being used currently. This is useful when you have multiple encoders.
----------------------------	---

Preview thumbnails	<p>The thumbnails on top provide a preview of the selected video and audio streams for each monitor (or layout).</p> <p>Note: The video preview is based on the input video stream and not a true representation of the monitor output. Since it is only a simulation of what is displayed, there could be some differences between the preview and what is actually displayed on the monitor in terms of the aspect ratio or the time the content appears on the screen.</p> <ul style="list-style-type: none">▪ Monitors – Click one of the thumbnails to see if a stream, or multiple streams, are assigned to the monitor or layout. If assigned, the details of the streams will display in the video layout below. If a stream is not yet assigned, you can drag a stream from the streams list on the left to the video layout below where “Drag and drop a video source here” is displayed.▪ Audio line out – Click to see the audio stream assigned. If an audio stream is not yet assigned, you can drag an audio stream from the streams list on the left onto the audio layout below where “Drag and drop an audio source here” is displayed. For multi-stream layouts, you can have up to five Audio line out assigned (one for each monitor and one headphone or speaker out).
---------------------------	---

<p>Video layout</p>	<p>The single-panel or multi-panel video layout on the right represents the video and how the stream is going to be displayed on the output surface (single monitor). The connection can use MP2TS, RTSP, RTP, or SRT network protocols.</p> <p>You can select a video stream and drag it onto the video layout if it is a single-panel layout, or onto one of the panels if it is a multi-panel layout. Temporarily, the video layout shows the encoder name, the protocol, the URL, and the port used. Click the Apply button to apply the video decoding configuration to the decoder. A video thumbnail is captured and displayed in the video layout. Note: If you want to use the same stream for the audio, you can drag and drop the stream from the video layout to the audio layout.</p> <ul style="list-style-type: none"> ▪ Settings – To set the scaling, and/or ProcAmp (processing amplifiers) options (adjust the image brightness, contrast, hue, and saturation), right click on the panel and select Settings (or, double click) to bring up the PowerStream Plus - Panel settings screen. For scaling, the options are Center in display, Stretch in display, and Fit in display. For more information, see “Scaling”, page 162 and “Image appearance”, page 163 topics. <p>Note: The settings are available for each panel and allow you to set different scaling and/or color space options for each stream independently.</p> <ul style="list-style-type: none"> ▪ Remove stream from panel – To remove a video stream from the video layout, right click and select Remove stream from panel.
<p>Audio layout</p>	<p>Below the video layout is the audio layout representing what the device will decode as audio for the same layout. Supports High-Efficiency Advanced Audio Coding standards (AAC-HE v1 and AAC-HE v2).</p> <p>You can select the audio stream and drag it onto the audio layout and click the Apply button to apply the audio decoding configuration to the decoder. Note: If you want to use the same stream for the video, you can drag and drop the stream from the audio layout to the video layout.</p> <ul style="list-style-type: none"> ▪ Remove stream from panel – To remove an audio stream from the audio panel, right click and select Remove stream from panel.

Display streams information	<p>To view the information of the streams on the layout, select Display streams information. The stream information is displayed on the video as well as the audio layout as the information could be different for both.</p> <p>The information is displayed on three lines:</p> <ul style="list-style-type: none"> ▪ The first line contains the friendly name of the video. ▪ The second line contains the stream URL. ▪ The third line contains the resolution, frames per second, pixel format, and the bit rate. Also indicates if the stream is synchronized. Note: Synchronization is maintained by the decoder if the source signals connected to the Maevox encoder running on version 3.00.00 or later are frame-synchronous. A private communications channel with the Maevox encoder enables a more accurate synchronization between multiple streams.
Audio control bar	<p>You can adjust the audio by dragging the audio control bar as required, or click the audio icon to mute the audio.</p>

7.1.1 Add a stream to the list manually

PowerStream Plus detects streams available for decoding automatically and displays them in the streams list. Streams requiring authentication may not automatically appear on the streams list. You need to manually add streams (also referred to as “custom streams”) that are required for decoding but are not automatically detected and displayed in the streams list. The details you need to enter differ depending on the streaming protocol you select. The streaming protocols you can select are: **RTSP**, **MPEG-2 TS**, and **SRT**.

To decode a RTSP or SRT stream with authentication, you must create a corresponding custom stream in the decoder and enter the appropriate stream credentials. You need to do this for each stream requiring authentication, for each device.



Note: The stream you enter manually is initially available only on that instance of PowerStream Plus. When you use this custom stream in a panel of the decoding layout, then click **Apply**, if this stream doesn’t require authentication (a user and password for RTSP, or a passphrase for SRT), then it will be available in the **Streams** list when another instance of PowerStream Plus connects to the same device. If the custom stream is not used in any decoding layout, it won’t be available for another instance of PowerStream Plus connecting to the same device, even when you click **Apply**. In this case, you have to add the custom stream manually to the new instance of PowerStream Plus.



Note: A stream entered manually with credentials (a user and password for RTSP, or a passphrase for SRT) by one user and enabled in a layout cannot be enabled in a new layout by another user. The second user can only drag the stream to another video or audio panel in the same layout. If the second user removes the stream from the layout created by the first user, the second user will not be able to re-enable the stream in the layout after that.

7.1.1.1 Add a RTSP stream

If there are any RTSP streams from the MaeveX encoder that are needed for decoding but they are not automatically detected by PowerStream Plus, you need to add them manually. Do the following to add a RTSP stream manually.

- 1 From the Decoding screen, select **New stream**.
- 2 In the **PowerStream Plus - Stream item** dialog box, select **RTSP** from the **Stream protocol** drop-down list.
- 3 Enter a friendly name for the stream in **Name**.

Stream protocol	RTSP
Name	Enter the stream name
Routing Scheme	Automatic Routing Scheme
URI	Stream Uri. Ex.: rtsp://192.168.154.186:3049/S1
Use authentication	<input checked="" type="checkbox"/>
User name	Enter username
Password	Enter password

- 4 Select **Unicast**, **Multicast**, or **TcpInterleave** from the **Routing scheme** drop-down list. **Note:** If you want to use the RTSP over TCP Interleave routing scheme between a MaeveX 6100 Series encoder and MaeveX 6100 Series decoder, you have to create a unicast RTSP stream on the encoder, then create a custom stream on the decoder using the RTSP over TCP Interleave routing scheme (**TcpInterleave**).
- 5 Enter the URI name or location of the stream in **URI**.
- 6 If the RTSP stream in the MaeveX encoder is set to use stream credentials and protected with encryption, then select **Use authentication** to enter the *same* stream credentials for this RTSP stream being manually added in the MaeveX 6152 decoder.
- 7 Enter the user name and password in the **User name** and **Password** fields. **Note:** Any name and password combination can be used for the stream credentials in the MaeveX encoder. The stream credentials could either be different for each RTSP stream, or the same for all the RTSP streams. You *must* ensure that you use the same stream credentials here.
- 8 Click **Save** to save this RTSP stream to the list.

7.1.1.2 Add a MPEG-2 TS stream

Do the following to add a MPEG-2 TS stream manually.

- 1 From the Decoding screen, select **New stream**.
- 2 In the **PowerStream Plus - Stream item** dialog box, select **MPEG-2 TS** from the **Stream protocol** drop-down list.
- 3 Enter a friendly name for the stream in **Name**.
- 4 Select **Unicast** or **Multicast** from the **Routing scheme** drop-down list. For **Multicast** routing, enter the address in **Multicast address**.
- 5 Enter the port number, between 1 and 65535, in **Port**.
- 6 Enter the IP address of the encoder in **Encoder address**.
- 7 Click **Save** to save the stream to the list.

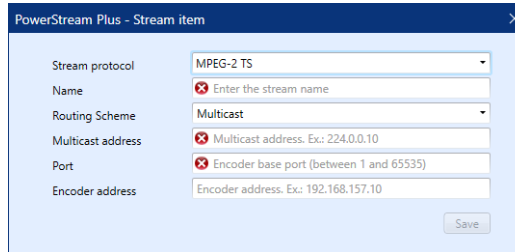

The screenshot shows the 'PowerStream Plus - Stream item' dialog box. The 'Stream protocol' is set to 'MPEG-2 TS'. The 'Name' field is empty with a red 'X' icon and the text 'Enter the stream name'. The 'Routing Scheme' is set to 'Multicast'. The 'Multicast address' field is empty with a red 'X' icon and the text 'Multicast address. Ex.: 224.0.0.10'. The 'Port' field is empty with a red 'X' icon and the text 'Encoder base port (between 1 and 65535)'. The 'Encoder address' field is empty with the text 'Encoder address. Ex.: 192.168.157.10'. A 'Save' button is located at the bottom right.

7.1.1.3 Add a SRT stream

Do the following to add a SRT stream manually.

- 1 From the Decoding screen, select **New stream**.
- 2 In the **PowerStream Plus - Stream item** dialog box, select **SRT** from the **Stream protocol** drop-down list.
- 3 Enter a friendly name for the stream in **Name**.
- 4 Select **Default**, **Listener**, **Caller**, or **RendezVous** in **Connection type**.
- 5 Enter the IP address of the encoder in **Encoder address**.
- 6 Enter the port number, between 1 and 65535, in **Port**.
- 7 Enter a value between 20 and 300 ms in **Latency (ms)**. The default is 40 ms.

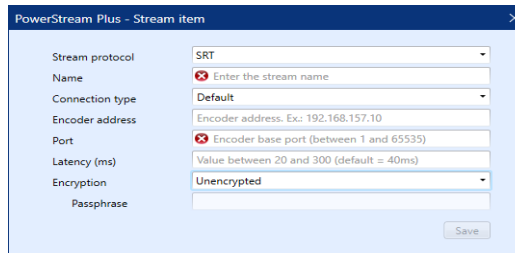



The screenshot shows the 'PowerStream Plus - Stream item' dialog box. The 'Stream protocol' is set to 'SRT'. The 'Name' field is empty with a red 'X' icon and the text 'Enter the stream name'. The 'Connection type' is set to 'Default'. The 'Encoder address' field is empty with the text 'Encoder address. Ex.: 192.168.157.10'. The 'Port' field is empty with a red 'X' icon and the text 'Encoder base port (between 1 and 65535)'. The 'Latency (ms)' field is empty with the text 'Value between 20 and 300 (default = 40ms)'. The 'Encryption' is set to 'Unencrypted'. The 'Passphrase' field is empty. A 'Save' button is located at the bottom right.

- 8 To define a SRT stream without encryption, select **Unencrypted** in the **Encryption** drop-down list. To define a SRT stream with encryption, select the encryption method used in **Encryption** (**AES-128**, **AES-192**, or **AES-256**) and enter a passphrase between 10 to 79 characters in **Passphrase**. **Note:** The encryption method and passphrase *must* be the same as defined for the stream in the Maevox encoder or third-party encoder settings.
- 9 Click **Save** to save the stream to the list.

7.1.2 Edit a manually added stream

You can edit (or delete) a stream that was manually entered.

- 1 In the stream list, move your mouse over the manually added stream that needs to be edited. Edit () and delete () icons appear.
- 2 Click the edit () icon.
- 3 Make your changes for the stream.
- 4 Click **Apply** for the changes to take effect.

7.1.3 Change the name of a custom stream (on the device)

You can change the friendly name of a stream if it is a custom stream that you created.

- 1 Select the stream from the stream list in the Decoding page and click the edit () icon.
- 2 Enter a new friendly name for the custom stream.
- 3 Drag and drop the stream in a video or audio panel of a layout. PowerStream Plus detects the name change and the **Apply** button is now enabled.
- 4 Click **Apply** for the stream name to be changed in the originating device as well.

7.2 Layouts

Use the **Layouts** page to enable the physical output layouts for the monitor. You can also choose your display mode and pixel format options for your monitors. You can set the panel schemes to apply to the output layout.

You can select a single-panel single-output layout or a multi-panel single-output layout. You can have up to four layouts for a single device.

You could also have a single layout with a single panel displaying content synchronously on multiple outputs (monitors or other physical displays). For example, you can play a 4K video on a single layout containing four HD monitors. You can have different monitor models in the same layout, as long as they share the same display mode and refresh rate. However, we recommend using the same model

monitors for a better experience as there could be tearing between the monitors if they don't have the same display timing. If audio is configured on the layout, the audio is sent to HDMI 1 in the layout. The synchronization tolerance is 40 ms.

Note: The number within brackets beside the **Layout** menu option indicates the number of layouts currently in use.



Note: At an initial boot, or after a factory reset, the default configuration is four independent layouts containing one monitor each, and a single stream per output.

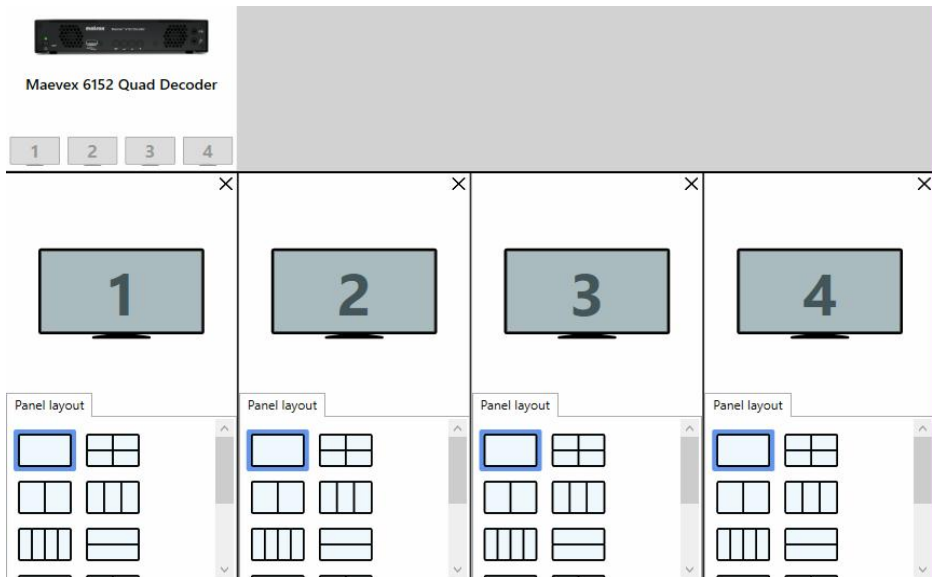

<p>Panel layout</p>	<p>Choose a panel scheme for the layout from the Panel layout options. The selected option is highlighted.</p> <p>The following are the default Panel layout options:</p> <ul style="list-style-type: none"> ▪ Single output ▪ 2 x 1 ▪ 1 x 2 ▪ 1 x 3 ▪ 1 x 4 ▪ 3 outputs, with a single output on the top ▪ 3 outputs, with a single output on the bottom ▪ 2 x 2 ▪ Picture in picture, the small picture on the top left ▪ Picture in picture, the small picture on the top right ▪ Picture in picture, the small picture on the bottom left ▪ Picture in picture, the small picture on the bottom right
<p>User layout</p>	<p>You can choose a panel scheme for the layout from the User layout options if you did not select an option from Panel layout.</p> <p>Note: Default panel layout options provided with the PowerStream Plus software display under Panel layout. OEM integrators can customize the panel layout options by adding new panel layouts with specific panel schemes. There can be a maximum of 16 custom panel layouts. These customized panel layouts are listed alphabetically and display under User layout. For more information, contact the Matrox Technical Support team.</p>
<p>Configuration tab</p>	<p>The Configuration tab displays when you have two or more monitors in the same layout. The monitor boundary border is highlighted. You can double click to define the gap between the monitors' boundaries.</p> <ul style="list-style-type: none"> ▪ Monitor position – You can select a monitor layout from the Monitor position pre-defined options (1 x 4, 4 x 1, 1 x 3, 3 x 1, and 2 x 2). <p>Note: Depending on the monitor layout you select, the Horizontal bezel (pixel) and/or Vertical bezel (pixel) option is available for you to set the values for making bezel adjustments.</p> <ul style="list-style-type: none"> ▪ Horizontal bezel (pixel) – Define the gap between the monitor boundaries (in pixels) for bezel management. ▪ Vertical bezel (pixel) – Define the gap between the monitor boundaries (in pixels) for bezel management.

Settings	<p>To access the layout options, right click and select Settings, (or double click). In the Layout settings dialog box, select your display mode and pixel format options. Note: The monitor options are applicable for the whole layout. When multiple monitors are used in a layout, all the monitors will be set to the same resolution and their destination set to the same pixel format. When a single monitor is used in each layout, you can set a different mode on each layout independently.</p> <ul style="list-style-type: none">▪ Select Force the display mode on the monitors if you want to use the default display mode of the monitor, if not, choose a resolution and refresh rate from the list of options provided under Display mode. For a layout with bound monitors, only the display modes common to all the monitors are available for selection in the Display mode drop-down list. When the preferred resolution of a monitor is UHD 60 Hz, the refresh rate defaults to 30 Hz instead of 60 Hz. If you would like the monitor to follow the stream resolution, select Automatically match video stream resolution when possible. Click OK to save your changes.
-----------------	--

	<ul style="list-style-type: none"> ▪ Select Force the pixel format on the layout if you want the pixel format for the layout to be selected automatically based on the pixel format of the stream(s). If there is a single stream, the pixel format coming from that stream is used (except when it is 4:0:0 8 bits, 4:2:0 8 bits is used as there is no automatic support for 4:0:0 8 bits). If there are multiple streams, this sets the pixel format automatically to the highest input pixel format coming from the streams. <p>The default is 4:2:0 8 bits, but if there is at least one stream with 10 bits, then it is set to 4:2:0 10 bits. If there is at least one stream in 4:4:4, it is set to 4:4:4: 8 bits. If there is at least one stream in 4:2:2, it is set to 4:2:2: 8 bits. For example, if one stream is 4:2:0 8 bits, another is 4:2:2 8 bits, and another is 4:2:0 10 bits, it will be set to 4:2:0 10 bits automatically. HDMI output stage will automatically convert to 8-bit RGB in all cases.</p> <p>Note: 4Kp60 in YUV 4:4:4 pixel format selected in PowerStream Plus at the compositing or layout stage can only be transferred to HDMI Outputs 1 and 3 (HDMI Outputs 2 and 4 cannot be used in this case). If you would like to set the pixel format, you can choose it from the Pixel format list - YUV 4:2:0 8 bits, YUV 4:2:2 8 bits, YUV 4:4:4 8 bits, YUV 4:2:0 10 bits. Click OK to save your changes.</p> <p>Note: The outgoing (HDMI) pixel format is always 8-bit RGB 4:4:4(automatically converted by the HDMI output stage), but it is better to set the appropriate pixel format for the destination based on the pixel format of the streams displayed. This will reduce the processing load on the device.</p> <ul style="list-style-type: none"> ▪ If you would like to have a fixed latency between a Maevox encoder and a Maevox 6152 decoder, you need to select the Force the latency between the source and the monitor option. The default fixed latency is 200 ms. You can override this by setting a value between 200 and 400 ms under Latency (ms). This option is useful when you want multiple Maevox 6152 decoders to play the same content frame synchronously. Note: This option can be used only when there is a private communications channel in place between a Maevox encoder and a Maevox 6152 decoder.
<p>Remove output from layout</p>	<p>To remove the current monitor from the layout, right click and select Remove output from layout.</p>

7.2.1 Add a multiple-layout decoding configuration (independent-output layouts with single panel and/or multi panels)

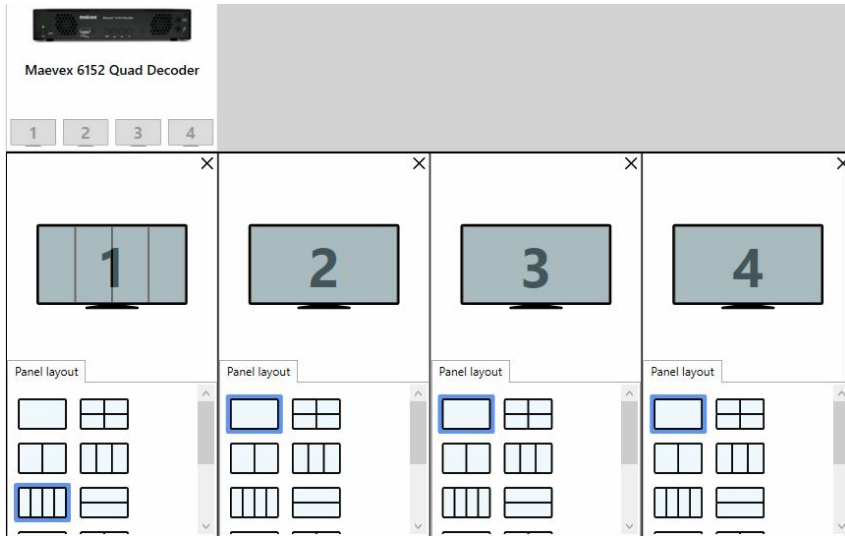

To add a multiple-layout decoding configuration with the audio and video streams, and the corresponding layouts:

- 1 From the **Layout** page, select a panel scheme for each layout from **Panel layout** and click **Apply**.
- 2 From the **Decoding** page, click on a thumbnail.
- 3 From the streams list on the left, drag and drop a stream into the video panel to the right. The stream name and URI are displayed immediately together with a background. Repeat step if this is a multi-panel layout, until all the panels have a video stream associated with them.
- 4 From the streams list on the left, drag and drop an audio stream into the audio layout that is below the video layout. **Note:** If you want to use a same video stream for the audio, you can drag and drop the stream from the video panel to the audio layout.
- 5 Adjust the audio bar as required, or click on the icon to mute the audio.
- 6 Repeat steps 2 to 5 until you have assigned streams for all the decoding layouts.
- 7 If you want to use an analog audio, click the **Audio line out** thumbnail and drag the audio source to the audio layout.

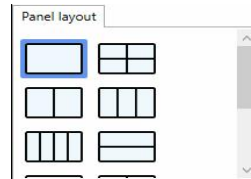

- Click the **Apply** button to apply this video decoding configuration to the decoder. The streams will now display in the thumbnails.



Note: The same configuration can be applied to two or more outputs. In this case, the performance is optimized by doing the decoding and compositions only once.

7.2.2 Add a single-layout decoding configuration (one multi-output layout with a single panel) or combination layouts

Example 1: A single (1x4) layout configuration stretched across four bound monitors.

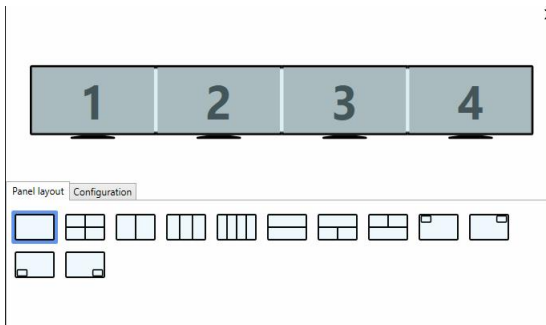

Example 2: Combination configuration with bound (1x2) layout and independent monitor layouts.

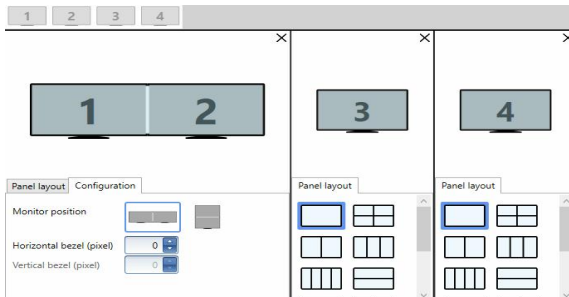

To add a single layout or combination layout decoding configuration, and the audio and video stream(s), do the following:

- 1 From the **Layout** page, drag the monitor thumbnail **1** from top and drop it into the layout section below.

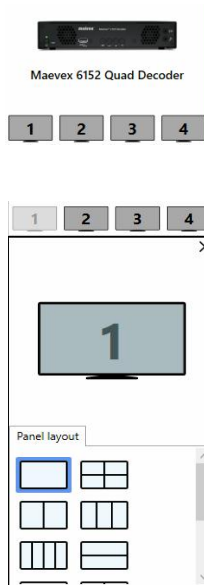

- 2 If you would like to bind monitors **1** and **2** together, drag the monitor thumbnail **2** from the top of the screen and drop it into monitor **1** in the layout section below. The **Configuration** tab displays now.

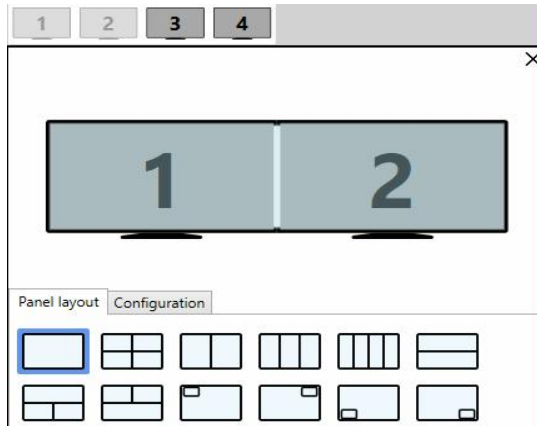

Note: If you try to drag and bind a monitor that doesn't share even a single display mode with the layout where it is dropped, then a warning displays and the monitor cannot be dropped because it doesn't have an output mode compatible with the layout.

- 3 Repeat for monitors **3** and **4** if you would like to bind all four monitors together.

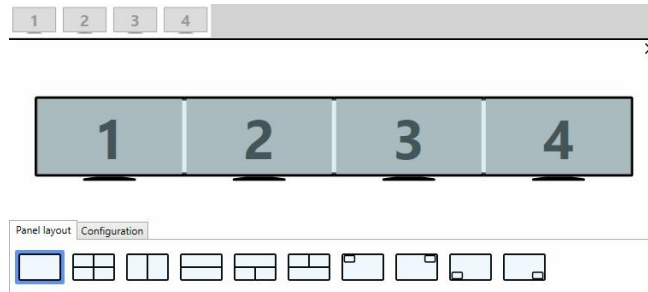

- **Note:** You can also choose to have a combination configuration with a mix of joined and independent monitors in layouts. For example, monitors **1** and **2** joined, and monitors **3** and **4** being independent. In this case, you can drag monitor **3** thumbnail from top and drop it into the new layout section below. Repeat for monitor **4**.

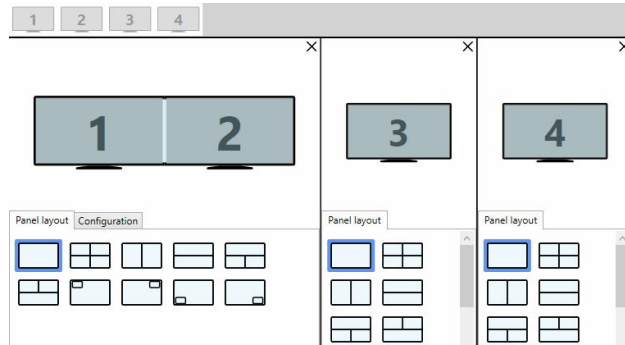

- 4 For a layout with joined monitors, from the **Configuration** tab, select a monitor layout option from **Monitor position** and set the bezel value(s). **Note:** For a 1 x 4 configuration, you can set only the horizontal bezel value in **Horizontal bezel (pixel)**. For a 4 x 1 configuration, you can set only the vertical bezel value in **Vertical bezel (pixel)**. For a 2 x 2 configuration, you can set both the horizontal and vertical bezel values.

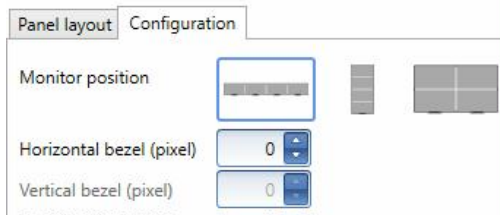

- 5 Select any option from **Panel layout**.

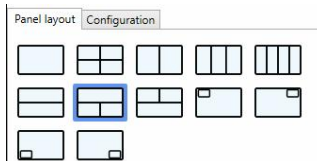

- 6 Right click and select **Settings**. Set the options in the **Layout settings** screen. **Note:** For a layout with joined monitors, only the display modes common to all the joined monitors display. Click **Apply**.

- 7 From the **Decoding** page, click on a layout thumbnail on top.

- 8 From the streams list on the left, drag and drop a stream into the video panel to the right. **Note:** For a layout with joined monitors, a single video panel is shown. The stream name and URI are displayed immediately together with a background.

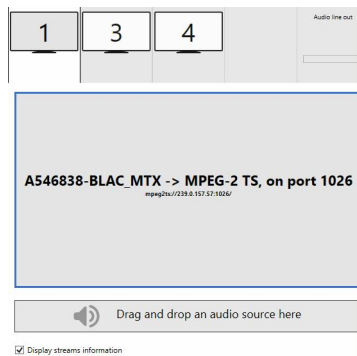
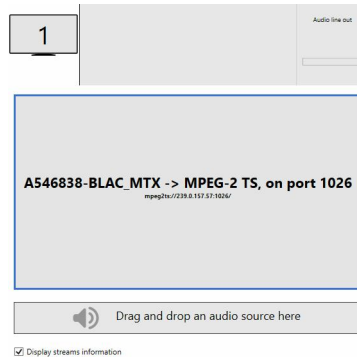

- 9 From the streams list on the left, drag and drop an audio stream into the audio layout that is below the video layout. **Note:** If you want to use a same video stream for the audio, you can drag and drop the stream from the video panel to the audio layout.
- 10 Adjust the audio bar as required, or click on the icon to mute the audio.
- 11 For a combination configuration, repeat steps 7 to 10 until you have assigned the video and audio stream for all the panels/outputs in the layout(s).
- 12 If you want to use an analog audio, click the **Audio line out** thumbnail and drag the audio source to the audio layout.
- 13 Click the **Apply** button to apply this video decoding configuration to the decoder. The stream will now display in the thumbnail(s).

7.3 Messaging overlay

You can have an emergency message or notification displayed at the bottom of each monitor.

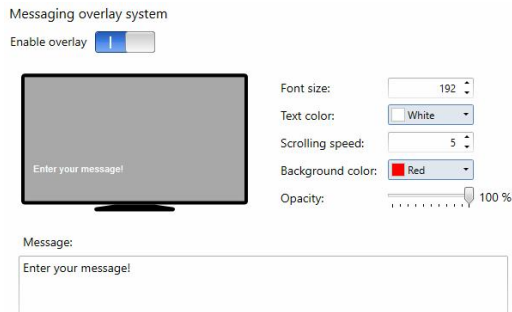

Enable overlay	Set it to the on (<input checked="" type="checkbox"/>) or off (<input type="checkbox"/>) position. Setting it on starts the messaging broadcast. The Messaging overlay tab label appears in red as Messaging overlay (on) when the Enable overlay option is set to on.
Message	Enter your message in the box using up to 1000 characters. Note: If you enter more than 1000 characters, the overflowing characters will not be displayed on the monitor even if you are able to see them in the Message box. You can set the Font size and Text color , the Background color for the textbox and its Opacity , and the Scrolling speed for the message. Scrolling can be disabled by setting Scrolling speed to 0. You can see the preview of the message as it would be displayed in the Messaging overlay panel.

7.4 Network

This contains the network settings for the connection and the IP address of your decoder.

Configuration	IPv4 and IPv6
IPv4 address	<input checked="" type="radio"/> Dynamic IP address (DHCP) <input type="radio"/> Static IP address
IPv4 address	<input type="text" value="192.168.177.61"/>
IPv4 netmask	<input type="text" value="255.255.240.0"/>
IPv4 gateway	<input type="text" value="192.168.176.1"/>
DNS servers	<input type="text" value="192.168.225.20 192.168.225.21"/>
IPv6 address	<input checked="" type="radio"/> Dynamic IP address (DHCP) <input type="radio"/> Static IP address
IPv6 address	<input type="text" value="fdea:dbee:fdea:d176:1ec"/>
IPv6 prefix length	<input type="text" value="128"/>
IPv6 gateway	<input type="text" value="N/A"/>
DNS servers	<input type="text" value="fdea:dbee:fdea:d145:20"/>
IEEE 802.1X	<input checked="" type="checkbox"/> This feature requires a certificate to be deployed on the device. To use this feature, install the certificate using the firmware updater.
Enable EAP-TLS	<input type="checkbox"/>
EAPOL Version	<input type="text" value="1"/>



Note: The device will reboot if you make a change and apply it. We recommend you to remove any active streams before making any change to the network configuration.

7.4.1 Configuration

Select if you want to configure your device to support **IPv4**, **IPv6**, or **IPv4 and IPv6**. The default is **IPv4 and IPv6**.

7.4.2 IP address

Select how to assign an IP address to your decoder.

By default, **Dynamic IP address (DHCP)** is used. For information on manually assigning a **Static IP address**, see “3.1 - Network discovery”, page 20.

7.4.3 IEEE 802.1X EAP-TLS

The 802.1X is a standard used to control access to a network for devices and PCs. MaeveX uses the EAP-TLS protocol used by 802.1X to securely identify a device prior to its authorization to join the network.

The **IEEE 802.1X** sub-section becomes available only after the certificates necessary for 802.1X are uploaded via the firmware updater. For more information, refer to the *Store a certificate file on the device for IEEE 802.1X EAP-TLS* topic in your Matrox MaeveX Series Firmware Updater document.

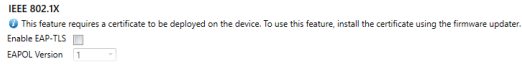

When you enable the **Enable EAP-TLS** option, you need to choose the **EAPOL version** from the drop-down list.



Note: The EAPOL version information will be provided along with the certificates by your IT department (in charge of the network where 802.1X is used).

For more information, see [“8.2.3.1 - Configure a device for deployment on a 802.1X EAP-TLS network”](#), page 105.

7.5 RS232

The decoder can receive RS232 commands over the network and transfer RS232 commands to the third-party RS232 device (for example a display) connected to the decoder. This allows the user to control the RS232 device from remote over IP through the Maevox decoder, eliminating the need for RS232 cabling and its associated cable length limitations. The **RS232** option allows you to change the RS232 settings.

RS232 virtualization

Disabled ▾

TCP port 11999 ▾

RS232 settings

Baud rate 115200 ▾

Data bits 8 ▾

Parity None ▾

Stop bits 1 ▾

Flow control None ▾

RS232 settings can be done for multiple devices simultaneously using the **Multi-device settings** option. For more information, see “7.9 - Modify settings”, page 87.

<p>RS232 virtualization</p>	<p>To enable RS232 virtualization (RS 232 over IP), select the type of RS232 connection to use.</p> <ul style="list-style-type: none"> ▪ Disabled – Disable RS232 to close the TCP port used for virtualization. ▪ Relayed serial over IP – In a relayed connection, the RS232 controller must be connected to your encoder to send commands to an RS232 device that’s connected to a decoder. The RS232 connection is independent of any other connection between an encoder and a decoder. Note: When using this option, the RS232 settings of your encoder are sent to the decoder. To establish a relayed connection, the encoder and the decoder must both use Relayed serial over IP. ▪ Direct serial over IP – In a direct connection, an IP-based RS232 controller application can send commands directly to the RS232 device connected to your decoder. The RS232 controller isn’t physically connected to a device. Any decoder that uses direct serial over IP receives the RS232 commands through an opened TCP port (for example, from a telnet session) and sends these commands to the RS232 device connected to it.
<p>TCP port</p>	<p>If Direct serial over IP is selected, select which port will receive the RS232 commands. (Make sure the port number is available and not used by another service on your network.) The default is 11999. This setting isn’t available if Relayed serial over IP is selected.</p>
<p>RS232 settings</p>	<p>If Relayed serial over IP is selected, the following settings are used by the encoder and the selected decoder. If Direct serial over IP is selected, the following settings are used only for the device connected to your encoder.</p> <ul style="list-style-type: none"> ▪ Baud rate – The speed, in bits per seconds (or baud), used for the RS232 connection. The default is 115200. ▪ Data bits – The number of bits per block of data transmitted. The default is 8. ▪ Parity – The type of parity bits (None, Odd, or Even) used for the data transmitted. The default is None. ▪ Stop bits – The number of bits used to identify the end of a data block. The default is 1. ▪ Flow control – The signal type (None or RTS/CTS) used to pause and resume data transmission. The default is None.

7.6 Date and time

Use this to update the date, time, NTP server URL, and time zone of your Maevex device. For more information on these settings, see “14 - Adjusting the date and time of your device”, page 169.

The current status/selection for the following is displayed in a section with a grey background:

- Synchronization
- NTP server URL
- Time zone

Date and time

Set a time zone
(UTC-5:00) Toronto

Set an NTP (Network Time Protocol) server URL
time.matrox.com

Current synchronization status Synchronized.

Current NTP server URL time.matrox.com

Current time zone (UTC-5:00) Toronto



Note: It is strongly advised to have a valid NTP server to ensure that all time-related features work properly. This is required on all networks, including secluded networks.

7.7 Local storage

You can manage your local storage using **Local storage**. You can upload files to the local storage, download files from the local storage, and also delete files. Failsafe content can be stored under local storage. The following file formats can be used in your local storage: MP4, FMP4, JPG, and PNG.

Disk Usage

Total size: 4.01 GB

Used size: 2.02 GB Remaining size: 1.99 GB

Search

Upload Download Delete Cancel

Name	size
<input type="checkbox"/> The Runaways - Cherry Bomb file://localhost/failsafe/mediast/The Runaways - Cherry Bomb.mp4	45.64 MB
<input type="checkbox"/> testrc_1280x720_60fps_yuv422_1hr_no_audio file://localhost/failsafe/mediast/testrc_1280x720_60fps_yuv422_1hr_no_audio.mp4	72.28 MB
<input type="checkbox"/> St. Vincent - Birth In Reverse file://localhost/failsafe/mediast/St. Vincent - Birth In Reverse.mp4	53.58 MB
<input type="checkbox"/> Peter Gabriel - Sledgehammer (HD version) file://localhost/failsafe/mediast/Peter Gabriel - Sledgehammer (HD version).mp4	129.41 MB
<input type="checkbox"/> Maeve6020_Panopto_Remote_Recorder_Teacher_4K file://localhost/failsafe/mediast/Maeve6020_Panopto_Remote_Recorder_Teacher_4K.mp4	214.73 MB
<input type="checkbox"/> Maeve6020_Panopto_Remote_Recorder_Enterprise_4K file://localhost/failsafe/mediast/Maeve6020_Panopto_Remote_Recorder_Enterprise_4K.mp4	152.69 MB
<input type="checkbox"/> Maeve6100Series_4K file://localhost/failsafe/mediast/Maeve6100Series_4K.mp4	159.93 MB

- **Disk usage** - Shows the **Total size**, the **Used size**, and the **Remaining size** of the local storage.
- **Search** - You can search for a file using the name of the file.
- **Upload** - Use this to upload files to the local storage.
- **Download** - Use this to download files from the local storage.
- **Delete** - Use this to delete a file.
- **Name** - Displays the name and path of each file in the local storage.
- **Size** - Displays the file size.

7.8 Other

Power recovery policy	<p>Set up your Maevox device to start up after a power loss.</p> <ul style="list-style-type: none"> ▪ Never start – Never start your Maevox device after a power loss. ▪ Always start – Always start your Maevox device after a power loss. ▪ Restore last state – Always start and restore the last state of your Maevox device after a power loss.
Power button control	To prevent your device from shutting down, enable the Disable shutdown option.
Reboot control	To force a reboot of your device if it stops responding, enable the Enable force reboot option.
Wake-on-LAN control	To remotely reboot an unresponsive Maevox device, enable the Enable Wake-on-LAN option.
DNS update	To update your DNS (Domain Name System) to use a friendly name instead of the device serial number, enable the Update DNS with friendly name option.

<p>Overlay</p>	<ul style="list-style-type: none"> ▪ Enable to display the media names over the screen – Select this option to display the media name on the monitor. ▪ Enable to display the audio icon over the screen – Select this option to display the audio icon on the monitor. The icon will show whether the audio is present or not, or whether the audio is muted. <p>Note: Displaying the media name or the audio icon has a direct impact on the video processing performance of the device. For example, if a device is close to its maximum performance, adding the media name or the audio icon might make the streams non-real time.</p>
<p>Failsafe</p>	<p>Defaults to the No failsafe option. You can select the failsafe content to be played from the local storage (listed under Local files), or from the USB (USB files). MP4, FMP4, JPG, and PNG file formats can be used. The system considers a stream as lost if there is no stream for five (5) seconds, then triggers and plays the failsafe content. A single failsafe content is played for all the streams.</p>
<p>Background color</p>	<p>Enable Background color to select the background color to display when:</p> <ul style="list-style-type: none"> ▪ Borders are required around the stream ▪ A stream is lost, or ▪ A video stream is not defined in a panel.
<p>Logs</p>	<ul style="list-style-type: none"> ▪ Download device logs – Download the log files. This file contains information on your Maevox devices. This information is useful for troubleshooting purposes. ▪ Erase device logs – Erase the log files created for your Maevox devices.
<p>Audits</p>	<p>Download the audit file. This file contains information on the user interactions with your Maevox devices. This information is used by your Maevox environment administrator.</p>

<p>Security</p>	<p>Only a Maevox 6152 decoder with the Enable copy protection (HDCP) support option enabled will decode protected content from a Maevox 6100 Series encoder. It will also receive and decode non-protected content from a Maevox 6100 Series encoder with the Enable copy protection (HDCP) support option disabled, or from any other third-party encoder source.</p> <ul style="list-style-type: none"> ▪ The decoder will only provide HDMI signal and content to HDCP-capable devices. ▪ Protected content streamed by a Maevox 6100 Series encoder can only be decoded by a Maevox 6100 Series decoder. ▪ The decoder will support and enable HDCP over ALL of its HDMI outputs irrespective of the decoded content, protected or unprotected. All decoded streams can only be displayed through HDMI outputs that are connected to a device with HDCP support; non-HDCP displays or devices will not receive any content or signal from such a protected decoder (displays will remain black). ▪ When a protected source content is already displayed on a maximum of 32 displays (could be across multiple Maevox 6152 decoders), mapping the protected source content to be displayed on the 33rd remote display will have the effect for this last decoder to block this content from being displayed through ANY of its 4 outputs (and therefore any displays directly or indirectly connected to this decoder). If failsafe is enabled on this decoder, the failsafe content will replace the protected content that can no longer be displayed through this decoder. Other decoders already displaying the same protected content will not be affected. ▪ The protocol used <i>must be</i> RTSP or RTP (MPEG-2 TS, HLS, RTMP, and SRT protocols don't support streaming of protected content). ▪ If a stream is secured but the device is not set for protected content support (the Enable copy protection (HDCP) support option is not enabled), the stream has a lock sign in the stream list and it cannot be used. In this case, you need to enable the Enable copy protection (HDCP) support option. <p>Note: When you select Enable copy protection (HDCP) support and click Apply, you will receive a confirmation message saying that you need to reboot the device for the change to take effect. Every output with a non-HDCP display or device connected will be automatically disabled.</p>
<p>Troubleshooting</p>	<ul style="list-style-type: none"> ▪ Debug configurations – Get help and troubleshooting information for your configuration. For more information, contact Matrox Technical Support.

7.9 Modify settings

To modify the settings for multiple devices at the same time:

- 1 From the PowerStream Plus main interface, press the [Ctrl] key, then select the tiles of the devices you want to modify. The device tiles you select must be of the same type.
- 2 From the PowerStream Plus main menu, click **Multi-device settings**.
- 3 Enable the **Modify settings** option.
- 4 Select your preferred device, then make your changes.
- 5 When you're done, click **Apply**. This applies the settings from the preferred device to the other selected devices.

7.10 Managing your Maevex 6152 Decoder configurations

For information on managing your Maevex 6152 Decoder configurations, see [“13 - Managing your configurations”](#), page 167.

7.11 Warning messages for a 6152 decoder

A warning sign () appears on the tile of the decoder when there is a warning or multiple warnings for the device. .



Note: The messages also appear in the decoding section under the **Other** option.

When you hover your cursor over the warning sign on the tile, one or more of the following warning messages will appear:

- Some of your monitors are not copy protection compliant.
- The device has exceeded its maximum video processing capability.
- The device has exceeded its maximum video decoding capability.
- A source is running under its target frame rate.
- A requested forced latency could not be enforced.
- The Messaging overlay text is too big to be fully displayed.
- The selected failsafe file could not be found.

7.11.1 Maximum video decoding and processing capabilities

When the device exceeds its maximum video decoding capability, a warning message “The device has exceeded its maximum video decoding capability” displays on the left when a device is selected.



Note: Make sure that you do not overload the processing capacity of the device. It is highly recommended to watch the **Video decoding** percentage and the **Video processing** percentage in the **Information dashboard** and maintain them under 100% at all times.

The processing capacity could get overloaded when decoding multiple streams, especially when using layouts to composite them onto a given output. When selecting the layouts, streams, and the settings, keep in mind that the maximum capabilities of the decoder are 2 x 4Kp60, 4 x 4Kp30, or 8 x HDp60, all at 4:2:0 8-bit. The same maximums apply for multi-region layouts with multi-stream compositing.

Try to limit or eliminate unnecessary scaling by setting the proper stream resolution on the encoder, or when generating or selecting the failsafe content. You could also avoid scaling due to display resolution by matching the stream resolution with the output resolution.

8 Maevex 6152 encoder settings

This enables you to view, configure, and manage settings specific to a Maevex 6152 Quad encoder.



Note: Don't change input or network connections while your Maevex device is turned on. If connections are changed while your Maevex device is turned on, your video sources or recordings will be lost.

8.1 Processing

8.1.1 Inputs/Outputs

An input box contains the following information about the video and audio signal detected by your encoder.

A	Input number	Identifies the input (1, 2, 3, and 4).
B	Input name	Lists the name of the input, as specified by the user.
C	Video signal	Detects the resolution and refresh rate of the video signal. If no signal is detected, this reads as (no video) .
D	Audio signal	Detects the HDMI audio signal. If no signal is detected, this reads as (no audio) . If audio is disabled, this reads as (audio disabled) .
E	Status	Indicates if the input is enabled or disabled for capture.
F	Pixel format	Defines the quality of the image captured.
G	EDID pass through	Outputs the video and audio signals of your source directly to your monitor and audio output device.
H	Connection status	Detects if an analog audio device is connected. If no device is connected, this reads as (no connection detected) .
I	Sample rate	Lists the sample rate of the analog audio signal.
J	Volume	Detects the volume level of your device.

You can configure the following settings for your inputs and outputs.

Enable input	To use an input as a source, you need to enable it. HDMI inputs are enabled by default.
Assign button	Assign a module (HDMI input , Streams , Local preview , or Recordings) to a button on your MaeveX 6152 device (Button 1 , Button 2 , Button 3 , or Button 4). Note: Before assigning a module, make sure that module is set to Enable . If you don't want to assign a button, select None .
Input name	Enter a name for each input.
Pixel format	The pixel format defines the quality of the image captured. YUV refers to the color format used to receive each block of bits in the video signal. The format is followed by the pixel depth used for each color in the image format. A higher YUV format and pixel depth provides a higher quality image and requires more resources to process.
Continue streaming on signal loss	Enable this option if you would like streaming to continue when signal is lost. Select an option under Audio format for the audio quality expected for your stream after a signal loss. If the audio is missing, or not in the format you select here, silence is generated. Note: When enabling this option, make sure to also select Continue streaming on signal loss for your stream under Processing (see "8.1.2 - Processing", page 91).
Disable EDID pass through	Output the video and audio signals of your source directly to your monitor and audio output device. To disable this feature, enable the Disable EDID pass through option.
Sample format	Specify the sampling rate, in kHz, and bit depth for your analog audio device.
Gain	Increase or decrease the amplitude, in dB (decibels), of your microphone.
Continue streaming when microphone is inserted or removed	Enable this option if the microphone analog audio signal is selected for your stream and you would like to have continuous streaming irrespective of microphone signal interruptions or disconnects. You need to also make sure that the Continue streaming on signal loss option is selected under Inputs/Outputs as well as Processing .
Volume	Increase or decrease the volume, in dB (decibels), of your headphones.

8.1.2 Processing



Note: To view and edit the settings of a processing module, click that module. The information appears on the right side of the panel.



Note: Depending on your configuration (for example, if you're using a single source layout), certain settings may not be available.

Select a processing to configure its source.

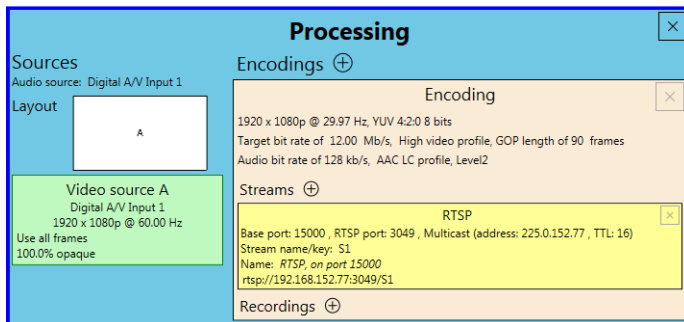

Audio source	The source of the audio signal to use.
Layout	The layout (picture in picture or picture by picture) and the number of sources to use.
Synchronize framelocked video input signal	Enable this to maintain frame synchronization when compositing from multiple sources (inputs).
Continue streaming on signal loss	Enable this to make sure streaming isn't interrupted if the source signal is switched or the connection to the device is lost. You can also set a background fill color for your composite layout. Note: When enabling this option, make sure to also select the Continue streaming on signal loss option for your stream under Inputs/Outputs (see “8.1.1 - Inputs/Outputs”, page 89).
Frame size	The width and height, in pixels, of the source. If the layout of your sources uses a height or width that's smaller than your frame size, black borders may appear on both sides, or on the top and bottom, of the frame. The width ranges from 64 to 4096 and must be a multiple of 16. The height ranges from 64 to 4096 and must be an even number.
Frame rate	The frame rate, in FPS (frames per second), for the source.



Background color	The background color for your source. If the layout of your sources uses less height or width than your frame size, the borders will use the background color. If no video is captured for your source, the background color is shown instead.
Pixel format	The pixel format to define the quality of your image, and the pixel depth for each color in the image format. A higher YUV format and pixel depth provides a higher quality image and requires more resources to process. Only certain pixel formats may be available.

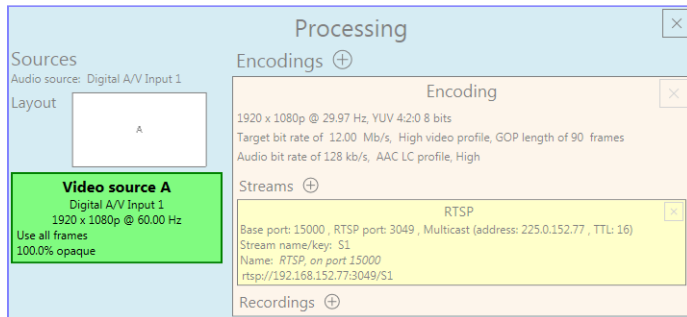

8.1.3 Source



Note: Depending on your configuration (for example, if you're using a single source layout), certain settings may not be available.

Input	Select the input to use for your source.
Capture rate	Select the frame rate for video capture. Reducing the frame rate also reduces the frame rate of the stream or recording. Note: When the incoming signal is at 4K60, the maximum is 4:2:2 encoding on a MaeveX 6152 or 6122 encoder.

<p>Scaling</p>	<p>Select how to scale your video:</p> <ul style="list-style-type: none"> ▪ Unscaled from top left – The video is unscaled and positioned in the top left corner of the display area. If the display resolution of the video is bigger than the display area, the video will be cropped. ▪ Unscaled centered – The video is unscaled and centered in the display area. If the display resolution of the video is bigger than the display area, the video will be cropped. ▪ Stretched to all edges – The video is stretched to fit the entire display area without respecting the aspect ratio of the original video. If the aspect ratio of the video and the display area don't match, the video may be distorted. ▪ Scaled to all edges – The video is scaled to fit the entire display area while respecting the aspect ratio of the original video. The video is centered in the display area. If the aspect ratio of the video and the display area don't match, the video will be cropped. ▪ Scaled to nearest edge – The video is scaled to fit to the display area while respecting the aspect ratio of the original video. The video is centered in the display area. If the aspect ratio of the video and the display area, black borders will appear on both sides of the video or above and below. The video isn't cropped.
<p>Pivot</p>	<p>Change the orientation of your source:</p> <ul style="list-style-type: none"> ▪ 0 degrees – No pivot is applied. ▪ 90 degrees clockwise – The source is rotated 90 degrees clockwise. ▪ 180 degrees – The source is rotated 180 degrees. ▪ 90 degrees counterclockwise – The source is rotated 90 degrees counterclockwise.
<p>Flip</p>	<p>Select the plane along which the source is flipped:</p> <ul style="list-style-type: none"> ▪ None – No flip is applied. ▪ Vertically – The source is flipped along the vertical plane. The top becomes the bottom. ▪ Horizontally – The source is flipped along the horizontal plane. The right side becomes the left. ▪ On both axes – The source is flipped along the vertical plane and the horizontal plane. This is visually similar to rotating 180 degrees.
<p>Opacity</p>	<p>Increase or decrease how opaque the source video appears. The default is 100%. </p>
<p>Brightness</p>	<p>Increase or decrease how light or dark the colors appear. The default is 500. </p>

Contrast	Change the difference in brightness between the lightest and darkest colors. The default is 500. 
Hue	Increase or decrease the tint or tone of colors. The default is 0. 
Saturation	Increase or decrease the depth of the colors. The default is 500. 

8.1.4 Encodings

These settings determine how your processor encodes, transmits, or records the video and audio signals.

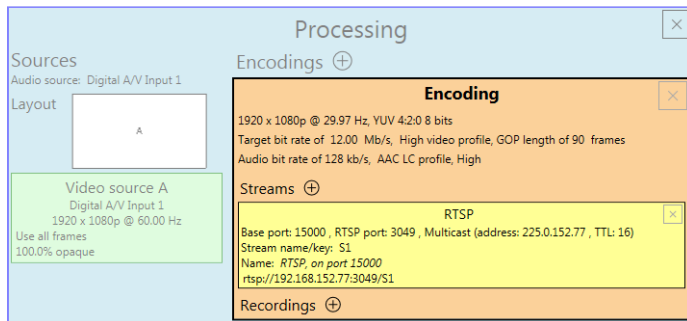

8.1.4.1 Adding an encoding

To add an encoding:

- **Custom encoding** – Click the **Add** (⊕) icon, then click **To Custom**. Enter the information for the selected protocol. The default is **RTMP**.
- **Content delivery network (CDN)** – Click the **Add** (⊕) icon, then click a preset (**Facebook Live**, **YouTube**, **Restream**, **Twitch**, **IBM Video Streaming**, **Vimeo**, or **Wowza Cloud**). Enter the information for the selected protocol.

8.1.4.2 Include

Select the signals to include (**Audio only**, **Video only**, or **Audio and video**) in your encoding.

8.1.4.3 Force encoding size

Enable this to have PowerStream Plus increase or reduce the captured video size before it's encoded.

Frame size	Specify the width and height, in pixels, of the video up to the width and height of the original video input. If your video source uses a different size, your encoder scales the video to the specified size (image may be distorted). The width ranges from 64 to 4096 and must be a multiple of 16. The height ranges from 64 to 4096 and must be an even number.
Scaling	Select how to scale your video: <ul style="list-style-type: none">▪ Unscaled from top left – The video is unscaled and positioned in the top left corner of the display area. If the display resolution of the video is bigger than the display area, the video will be cropped.▪ Unscaled centered – The video is unscaled and centered in the display area. If the display resolution of the video is bigger than the display area, the video will be cropped.▪ Stretched to all edges – The video is stretched to fit the entire display area without respecting the aspect ratio of the original video. If the aspect ratio of the video and the display area don't match, the video may be distorted.▪ Scaled to all edges – The video is scaled to fit the entire display area while respecting the aspect ratio of the original video. The video is centered in the display area. If the aspect ratio of the video and the display area don't match, the video will be cropped.▪ Scaled to nearest edge – The video is scaled to fit to the display area while respecting the aspect ratio of the original video. The video is centered in the display area. If the aspect ratio of the video and the display area, black borders will appear on both sides of the video or above and below. The video isn't cropped.
Pivot	Change the orientation of your source: <ul style="list-style-type: none">▪ 0 degrees – No pivot is applied.▪ 90 degrees clockwise – The source is rotated 90 degrees clockwise.▪ 180 degrees – The source is rotated 180 degrees.▪ 90 degrees counterclockwise – The source is rotated 90 degrees counterclockwise.

Flip	<p>Select the plane along which the source is flipped:</p> <ul style="list-style-type: none"> ▪ None – No flip is applied. ▪ Vertically – The source is flipped along the vertical plane. The top becomes the bottom. ▪ Horizontally – The source is flipped along the horizontal plane. The right side becomes the left. ▪ On both axes – The source is flipped along the vertical plane and the horizontal plane. This is visually similar to rotating 180 degrees.
-------------	---

8.1.4.4 Force pixel format

The pixel format defines the quality of the image encoded. YUV refers to the color format used to receive each block of bits in the video signal. The format is followed by the pixel depth used for each color in the image format. A higher YUV format and pixel depth provides a higher quality image and requires more resources to process.

8.1.4.5 Encoding profile

Encoding profile	<p>Select an encoding profile for your signal. Changing the encoding profile may prevent your decoder from streaming. Select one of the following:</p> <ul style="list-style-type: none"> ▪ Baseline ▪ Main ▪ High ▪ High, 10-bit ▪ High, YUV 4:2:2 ▪ High, YUV 4:4:4 Predictive ▪ High, YUV 4:4:4 CAVLC + Intra
Target bit rate	<p>The target bit rate, in Mb/s (Megabits per second), for encoding. The actual bandwidth used by your encoder varies according to your source and encoding method. The default is 15 Mb/s. A lower target bit rate may result in lower image quality. A higher target bit rate limit may result in lower performance, a higher bandwidth when streamed, and a larger file size when recorded.</p>
Bit rate control	<p>Select one of the following:</p> <ul style="list-style-type: none"> ▪ Use a variable bit rate ▪ Use a constant bit rate
Maximum bit rate	<p>The maximum bit rate for encoding. When encoding, the processor attempts to use the target bit rate but may use up to the maximum bit rate specified. The default is 22.5 Mb/s. The maximum bit rate is 120 Mb/s.</p>

Estimated H.264 level	The estimated level of support for a profile required from the decoder. For compatibility with the MaeveX 5150 decoder, ensure that the stream is H.264 level 4.2 or below.
Quantization parameters	The range used to compress the various frames in your GOP. A high maximum increases the level of compression of the frame and should decrease the bit rate but may decrease the image quality.

8.1.4.6 Encoding mode

Optimized for low latency	Reduces the delay between the time the video is captured on the encoder and the time it's shown on a monitor connected to a decoder.
Optimized for desktop	Provides a better image quality for static images (such as a computer desktop). Note: It is recommended to use the Optimized for desktop mode with the Use a variable bit rate option, with the Maximum bit rate set to at least twice the Target bit rate .
Favor image quality	Favors image quality over latency, but may require more delay.

8.1.4.7 Force CAVLC entropy encoding

Enable this to force the use of context adaptive variable length coding (CAVLC) entropy encoding. Enabling this option overrides the default entropy encoding selection (CABAC).

8.1.4.8 Group of pictures (GOP)

GOP length	The number of frames from one complete frame (I-frame) to another. A higher GOP length increases the compression level but may result in a lower quality image. The default is 90.
Insert P-frames every X frames	<p>Enter the interval at which a P-frame needs to be inserted. A P-frame (Predicted picture) contains only the changes from the previous frame. The frames between P-frames are B-frames. B-frames (Bidirectional predicted picture) contain the differences between the current frame and the previous frame as well as the subsequent frame.</p> <p>A higher number of B-frames before inserting a P-frame increases the quality of the image but may result in a loss of performance. The minimum and the default value in PowerStream Plus is 1 which represents zero B-frames between P-frames. The maximum value is 4 which inserts three B-frames between P-frames.</p> <p>Having a higher number of B-frames increases the motion distance between the P-frame and its references, hence the number of B-frames should be reduced for sports action sequences, and for very high resolution (UHD) or low frame rate requirements. You can use a higher number of B-frames for SD or HD resolutions.</p>

8.1.5 Audio

Bit rate	Select the audio bit rate, in kbps, for your audio transmission. A higher bit rate produces a sound quality closer to the source quality, but requires more bandwidth. The value ranges from 32 to 576. The default is 128.
AAC encoder	<p>Select one of the following:</p> <ul style="list-style-type: none"> ▪ AAC LC – Allowed bit rate range is 32 to 576 kbps. ▪ AAC HEv1 – Allowed bit rate range is 32 to 288 kbps. ▪ AAC HEv2 – Allowed bit rate range is 32 to 144 kbps.
AAC quality	<p>Force the use of encoding complexity (low to high) to improve the quality of compressed audio. Adjusting these settings doesn't affect the audio sample rate, target bit rate, or latency.</p> <ul style="list-style-type: none"> ▪ Low ▪ Medium ▪ High

Use temporal noise shaping	This reshapes the quantization noise over time to improve the quality of the audio signal. This option is enabled by default.
AAC format	Select one of the following: <ul style="list-style-type: none"> ▪ ADTS ▪ No container format

8.1.6 Streams

To add a stream (**RTP**, **RTMP**, **RTSP**, **SRT**, **MPEG-2 TS**, or **HLS**), click the **Add** (+) icon.

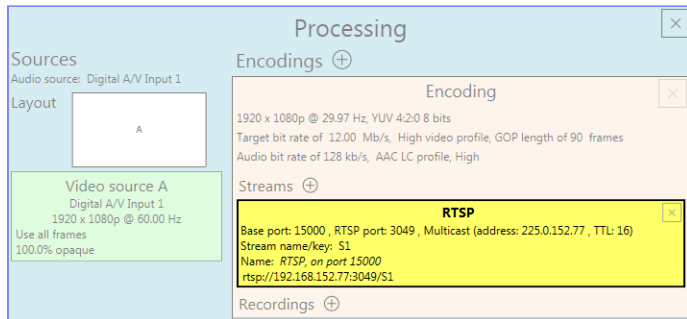

Note: If you configured your encoder to use **IPv4 and IPv6**, you must enable one stream for IPv4 and one stream for IPv6.

Note: To receive an RTP stream, you need to create an SDP file. For more information, contact Matrox Technical Support.

Note: When applying settings to multiple devices, make sure static IP addresses and multicast addresses aren't being duplicated. For more information, contact your network administrator.

Note: Depending on the stream selected, certain options aren't available.

Enable stream	Enable or disable your stream.
Assign button	Assign a module (HDMI input , Streams , Local preview , or Recordings) to a button on your Maevex 6152 device (Button 1 , Button 2 , Button 3 , or Button 4). Note: Before assigning a module, make sure it's set to Enable . If you don't want to assign a button, select None .

Stream address	RTSP only – The URL (or stream address) of your RTSP stream.
Base port	The port number used to transmit your stream.
Destination location	RTMP only – The path of your RTMP stream.
Playlist file name	HLS only – Enter the name of your playlist file.
Name	Enter a name for your stream.
Network interface	The network interface (LAN1 or LAN2) to use for the stream. To use the first IP address the device finds, select Automatic IPv4 to use an IPv4 address or Automatic IPv6 to use an IPv6 address.
Encoding ladder configuration	HLS only – Select how to configure the encoding ladder: <ul style="list-style-type: none"> ▪ Manual – Specify the bit rate and FPS (frames per second) decimation, then select the ladder to Enable for the HLS stream. To show resolutions that are automatically generated, enable Show auto-generated resolutions from video signal. ▪ Automatic – Specify the Number of steps (1 to 6, with 1 being the highest bit rate) in the encoding ladder.
RTSP port	RTSP only – The RTSP port number used to transmit your stream.
Stream name/key	RTMP and RTSP only – Enter a suffix as part of your stream address. If you're using a media player to decode your stream, the media player may require this as part of the stream address to connect to a stream.
Use authentication	RTMP and RTSP only – Enable this if you're using an authentication server, then enter your credentials (User name and Password).
Encryption	SRT only – The encryption level to secure your stream. Options include: Unencrypted , AES-128 , AES-192 , or AES-256 .
Passphrase	The passphrase used to generate the encryption key. We recommend a passphrase length of 16 characters (AES-128), 24 characters (AES-192), and 32 characters (AES-256). If Unencrypted is selected, there's no passphrase to enter.
Connection type	SRT only – Run SRT in Caller , Listener , or Rendezvous mode.
Latency	SRT only – The target latency, in milliseconds (ms), for transmission. The default is 40 ms.
Time to live (TTL)	The number of hops or network nodes (such as network switches or routers) through which a multicast signal can travel. Once the TTL number is reached, the receiving network node prevents the signal broadcast further down the network. The value ranges from 1 to 255. The default is 16.

Type of service	Set a value between 0 and 255 for the type of service (priority level) for outgoing network packets (except for the RTMP and HLS protocols). The default value is 0.
Routing scheme	<ul style="list-style-type: none"> ▪ Unicast – When selecting unicast, you need to specify the destination IP address of the stream. You can enter a valid IP address or host name. ▪ Multicast – Enter a Multicast address. Using multicast may require additional network configuration to support the transmission protocol (some network switches and routers can block multicast signals). For more information, contact your network administrator. To also allow unicast connections, enable the Allow unicast connections option.

8.1.7 Recordings

Use this option to record your video files on a network attached storage (NAS) device or an external storage device. The video files created are encoded with an H.264 video and AAC audio codec.

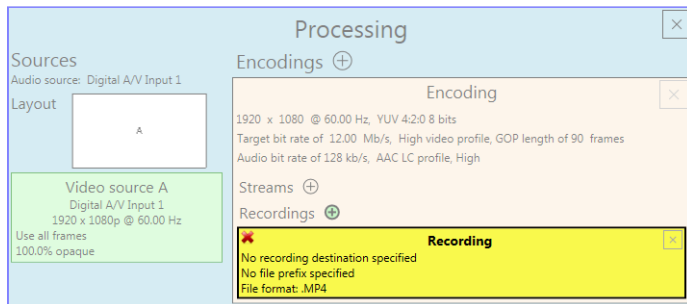

Note: When HDCP protection is enabled on a Matrox MaeveX 6152 or 6122 encoder, the recording option is disabled.



Note: When starting a recording manually or through a scheduled recording, it may take a few seconds for your encoder to actually record video. When scheduling a recording, we recommend you start the recording earlier than the actual time required.



Note: If your network is slow, congested, or experiencing high traffic, your recording may fail. For more information, contact your network administrator.

8.1.7.1 Enable recording

Enable this to be able to record from your device.

If **Scheduled recording** is enabled, this option isn't available.

8.1.7.2 Assign button

Assign a module (**HDMI input**, **Streams**, **Local preview**, or **Recordings**) to a button on your Maevox 6152 device (**Button 1**, **Button 2**, **Button 3**, or **Button 4**).



Note: Before assigning a module, make sure it's set to **Enable**.

If you don't want to assign a button, select **None**.

8.1.7.3 File name prefix

The video file name is made up of two parts:

- **First part** – The name, which you enter.
- **Second part** – The timestamp of when the video file started, which your encoder defines.

The resulting file name is *Prefix[YYYY-MM-DD_HH-MM-SS].mp4*, where YYYY is the year, MM the month, DD the day, HH the hour (in a 24-hour format), MM the minutes, and SS the seconds.

A file name prefix can be up to 19 characters long.

8.1.7.4 File format

Select the format for your recording (MP4 or MOV).

To use fragmented MP4, enable the **Use fragmented MP4 (fMP4)** option. This option ensures your recorded file won't be corrupted in the event your network connection is disrupted.

8.1.7.5 Maximum file block duration

Enter the recording time for each video file recorded. Once the recording time for a file is reached, PowerStream Plus creates a new file. A file can hold up to 8 hours of recording.

If the sampling rate (audio or video) changes, a new file is created, regardless of the file duration.

8.1.7.6 Recording location

Under **Record to**, provide the path to the existing network shared folder or select the external storage device where your video files will be stored.



Note: To make sure the network path is properly recognized by your device, we recommend you provide the full computer name or the IP address of the system where the shared folder is located. The full computer name is part of the Windows properties of the system. For example, the full computer name of networkserver may be *networkserver.domain.com*. For more information, contact your network administrator.

8.1.7.6.1 Add network shared folder

Enter the path to the existing network shared folder, then select how to connect to the shared folder:

- **Connect as guest** – If your network drive doesn't require user identification, use this. When you're done, click **OK**.
- **Connect with credentials** – If your network drive requires user identification, enter a **User name** and **Password**. **Note:** Include the domain in the **User name** field in one of the following formats: PCNAME\USER, USER@PCNAME, or USER@DOMAIN. When you're done, click **OK**.

8.1.7.6.2 Manage network shared folders

Use this to review your list of credentials, and to remove user names and passwords that are no longer required.

8.1.7.6.3 Eject device

To safely remove an external storage device from your system, select the device you want to remove, then click the **Eject** () button.

8.1.7.7 Scheduled recording

Enable this to schedule a date, time, and duration for your encoder to record a video file.

Start recording at	Enter the date and time to start recording.
Stop recording at	Enter the date and time to stop recording.

8.2 Network

This contains the network settings for the connection and IP address of your encoder.

	LAN1	LAN2
Configuration	IPv4 and IPv6	IPv4 and IPv6
IPv4 address	<input checked="" type="radio"/> Dynamic IP address (DHCP) <input type="radio"/> Static IP address	<input checked="" type="radio"/> Dynamic IP address (DHCP) <input type="radio"/> Static IP address
IPv4 address	192.168.178.43	192.168.2.107
IPv4 netmask	255.255.240.0	255.255.255.0
IPv4 gateway	N/A	192.168.2.1
DNS servers	192.168.225.20 192.168.225.21	
IPv6 address	<input checked="" type="radio"/> Dynamic IP address (DHCP) <input type="radio"/> Static IP address	<input checked="" type="radio"/> Dynamic IP address (DHCP) <input type="radio"/> Static IP address
IPv6 address	fdabcdbeefdead176:3588	
IPv6 prefix length	128	0
IPv6 gateway	N/A	N/A
DNS servers	fdabcdbeefdead145:20	
IEEE 802.1X	<input checked="" type="checkbox"/> This feature requires a certificate to be deployed on the device. To use this feature, install the certificate using the firmware updater.	
Enable EAP-TLS	<input type="checkbox"/>	
EAPOL Version	1	

8.2.1 Configuration

Select if you want to configure your device to support **IPv4**, **IPv6**, or **IPv4 and IPv6**.

8.2.2 IP address

Select how to assign an IP address to your encoder.

By default, **Dynamic IP address (DHCP)** is used. For information on manually assigning a **Static IP address**, see “3.1 - Network discovery”, page 20.

8.2.3 IEEE 802.1X EAP-TLS

The 802.1X is a standard used to control access to a network for devices and PCs. Maevex uses the EAP-TLS protocol used by 802.1X to securely identify a device prior to its authorization to join the network.

The **IEEE 802.1X** sub-section becomes available only after the certificates necessary for 802.1X are uploaded via the firmware updater. For more information, refer to the *Store a certificate file on the device for IEEE 802.1X EAP-TLS* topic in your Matrox Maevex Series Firmware Updater document.

IEEE 802.1X
<input checked="" type="checkbox"/> This feature requires a certificate to be deployed on the device. To use this feature, install the certificate using the firmware updater.
Enable EAP-TLS <input type="checkbox"/>
EAPOL Version 1

When you enable the **Enable EAP-TLS** option, you need to choose the **EAPOL version** from the drop-down list.



Note: The EAPOL version information will be provided along with the certificates by your IT department (in charge of the network where 802.1X is used).

8.2.3.1 Configure a device for deployment on a 802.1X EAP-TLS network

The EAP-TLS protocol requires the deployment of a certificate file on the device. **Note:** Each device must be configured individually. The certificate file contains the public server certificate authority, the client certificate, and the client private key associated with the device certificate.

Prior to joining the 802.1X network, the device has no IP address assigned to it. PowerStream Plus allows the administrator to configure a device to use 802.1X EAP-TLS for its network on-boarding. You can deploy this certificate file to the device using the Maevox firmware updater on a regular network first.

- 1 Deploy the Maevox device on a regular network without any 802.1X authentication.
- 2 Using the firmware updater, store the certificate file on the device (done by the administrator). **Note:** During the firmware updating process, the firmware updater will display the following progress status message: *Updating “EAP TLS certificate.”*

The certificate file should contain the following information:

- A certificate to identify the device. This certificate is used by the 802.1X authentication server to authenticate the device.
- The private key associated with the device certificate.
- The public certificate identifying the certificate authority (CA) used to sign the 802.1X authentication server (for example, the Radius server). This certificate is used by the device to verify the authenticity of the 802.1X authentication server, preventing hostile attacks.



Note: The certificate file has to be named *eaptls_cert.pem* and placed in the update package. The updater program will verify and deploy it to the right location.



Note: To uninstall the certificates from the device, you need to do a factory reset on the device.

- From PowerStream Plus, enable 802.1X EAP-TLS and configure the appropriate settings in the **Network** page of the device settings. That is, select the **Enable EAP-TLS** option and choose the **EAPOL version** from the drop-down list (these have to be done by the administrator).

Note: The **Enable EAP-TLS** option will not be available if the necessary certificates are not stored on the device.

- You can then disconnect the device from the normal network and connect it to an 802.1x network. Once connected, it will obtain an IP address.

Note: A device not properly configured for 802.1X EAP-TLS will be unable to obtain an IP address when it is connected to a 802.1X EAP-TLS network and hence will not be visible on the network. When the feature is disabled, the device will disappear from the network. In this case, you must connect the device to a network without 802.1X authentication, correctly configure the device as described above, then re-connect the device to the 802.1X network.

8.3 RS232

Enable this to virtualize an RS232 (or serial) connection.

RS232 virtualization

Disabled

Decoder
Select a decoder...

TCP port 11999

RS232 settings

Baud rate 115200

Data bits 8

Parity None

Stop bits 1

Flow control None

8.3.1 Enabling RS232 virtualization

To enable RS232 virtualization, select the type of RS232 connection to use.

Disabled	Disable RS232 to close the TCP port used for virtualization.
Relayed serial over IP	In a relayed connection, the physical RS232 controller must be connected to your encoder to send commands to an RS232 device that's connected to a decoder. The RS232 connection is independent of any other connection between an encoder and a decoder. When using this option, the RS232 settings of your encoder are sent to the decoder. To establish a relayed connection, the encoder and the decoder must both use Relayed serial over IP .

Direct serial over IP	In a direct connection, an IP-based RS232 controller application can send commands directly to the RS232 device connected to your encoder. The RS232 controller isn't physically connected to a device. Any encoder that uses direct serial over IP receives the RS232 commands through an opened TCP port (for example, from a telnet session) and sends these commands to the RS232 device connected to it.
Local control	Select this to add local encoder device control through the RS232 interface.

8.3.2 Configuring RS232

Select decoder	If Relayed serial over IP is selected, select the decoder that's connected to the RS232 device you want to communicate with. The RS232 connection is virtualized only between your encoder and this decoder. This setting isn't available if Direct serial over IP is selected.
TCP port	If Direct serial over IP is selected, select which port will receive the RS232 commands. (Make sure the port number is available and not used by another service on your network.) The default is 11999. This setting isn't available if Relayed serial over IP is selected.
RS232 settings	If Relayed serial over IP is selected, the following settings are used by the encoder and the selected decoder. If Direct serial over IP is selected, the following settings are used only for the device connected to your encoder. <ul style="list-style-type: none"> ▪ Baud rate – The speed, in bits per seconds (or baud), used for the RS232 connection. The default is 115200. ▪ Data bits – The number of bits per block of data transmitted. The default is 8. ▪ Parity – The type of parity bits (None, Odd, or Even) used for the data transmitted. The default is None. ▪ Stop bits – The number of bits used to identify the end of a data block. The default is 1. ▪ Flow control – The signal type (None or RTS/CTS) used to pause and resume data transmission. The default is None.

8.4 Date and time

Use this to update the date, time, and time zone of your Maevox device. For more information on these settings, see “14 - Adjusting the date and time of your device”, page 169.

8.5 Other

This contains the settings for protected content support (security), local preview, power recovery policy, power button control, reboot control, Wake-on-LAN control, DNS update, audits, logs, and troubleshooting.

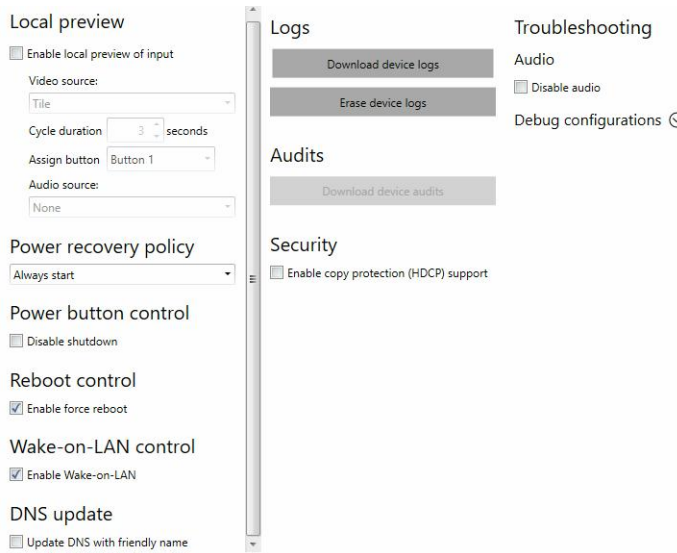

<p>Local preview</p>	<p>To preview your sources on your console display, enable the Enable local preview of input option, then select a Video source:</p> <ul style="list-style-type: none"> ▪ Input – Input stream appears full-screen. ▪ Tile – Input streams appear as a tile view. ▪ Cycle – Input streams cycle. Specify the Cycle duration, in seconds. <p>To assign the local preview to a button on your Maevex 6152 device (Button 1, Button 2, Button 3, or Button 4). If you don't want to assign a button, select None.</p> <p>If the option is enabled, select an Audio source from the list. If no input is available, None appears.</p>
<p>Power recovery policy</p>	<p>Set up your Maevex device to start up after a power loss.</p> <ul style="list-style-type: none"> ▪ Never start – Never start your Maevex device after a power loss. ▪ Always start – Always start your Maevex device after a power loss. ▪ Restore last state – Always start and restore the last state of your Maevex device after a power loss.

Power button control	To prevent your device from shutting down, enable the Disable shutdown option.
Recording control	To disable the recording module for a specific Maevox device, enable the Disable recording option. Your device will reboot for this change to take effect.
Reboot control	To remotely force a reboot of your device if it stops responding, enable the Enable force reboot option.
Wake-on-LAN control	6152 / 6122 encoder only – To remotely reboot an unresponsive Maevox device, enable the Enable Wake-on-LAN option.
DNS update	To update your DNS (Domain Name System) to use a friendly name instead of the device serial number, enable the Update DNS with friendly name option.
Logs	<ul style="list-style-type: none"> ▪ Download device logs – Download the log files. This file contains information on your Maevox devices. This information is useful for troubleshooting purposes. ▪ Erase device logs – Erase the log files created for your Maevox devices.
Audits	Download the audit file. When you click Download device audits , you'll be prompted to enter a password. The password entered encrypts the audit file. This file contains information on the user interactions with your Maevox devices. This information is used by your Maevox environment administrator.
Troubleshooting	<ul style="list-style-type: none"> ▪ Audio – To disable the audio on all of your Maevox 6100 Series devices, enable the Disable audio option. Your device will reboot for this change to take effect. ▪ Debug configurations – Get help and troubleshooting information for your configuration. For more information, contact Matrox Technical Support.

<p>Security</p>	<p>The Enable copy protection (HDCP) support option is applicable to the Maevox 6152 encoder. Select the checkbox to capture protected content over any of the HDMI inputs and decode it with the Maevox 6152 decoder.</p> <ul style="list-style-type: none"> ▪ When the Enable copy protection (HDCP) support option is enabled, the DisplayPort console output as well as the recording function are not supported. ▪ RTSP or RTP protocol must be used (HLS, SRT, RTMP, and MPEG-2 TS protocols are not supported for streaming of protected content). Note: If the DisplayPort console output, an unsupported streaming protocol, or the recording function is currently in use, you will not be able to enable the Enable copy protection (HDCP) support option and the following error message will display “<i>There is a streaming protocol or a recording in the processing section that is not compatible with HDCP.</i>” ▪ All local displays connected must be HDCP capable, otherwise the sources will not send protected content to the Maevox device. ▪ Any source content can be displayed on a maximum of 32 remote displays with HDCP support. Note: Third party HDMI / HDCP splitters connected to a Maevox 6152 decoder output will count as multiple display destinations, depending on the nature of the device and the number of displays connected to it. The use of such devices could quickly reduce the number of decoder outputs allowed to carry any given content originating from any encoder that is enabled for protected content support (with the Enable copy protection (HDCP) support option selected). ▪ Any content streamed by a Maevox 6152 (or Maevox 6122) encoder with copy protection (HDCP) support enabled, including non-HDCP-protected content received from HDMI sources, can only be decoded by a Maevox 6152 decoder which also has the Enable copy protection (HDCP) support option enabled. <p>A Maevox 6152 encoder with the Enable copy protection (HDCP) support option disabled will not capture and process any protected content from any source. Note: When you select Enable copy protection (HDCP) support and click Apply, you will receive a confirmation message saying that you need to reboot the device for the change to take effect. Every output with a non-HDCP device connected will be disabled.</p>
------------------------	--

9 Maevex 6122 encoder settings

This enables you to view, configure, and manage settings specific to a Maevex 6122 Dual encoder.



Note: Don't change input or network connections while your Maevex device is turned on. If connections are changed while your Maevex device is turned on, your video sources or recordings will be lost.

9.1 Processing

9.1.1 Inputs/Outputs

An input box contains the following information about the video and audio signal detected by your encoder.

The screenshot shows a grid of input settings for the encoder. Each input has a lettered icon (A-J) and a status indicator (I, H, J). The settings are as follows:

- HDMI 1 (A):** Digital A/V Input 1, 1920 x 1080p @ 59.99 Hz, Audio @ 44.1 kHz, 16 bits Stereo, Enabled (needs signal), YUV 4:2:0 8 bits, EDID pass through: Enabled.
- HDMI 2:** Digital A/V Input 2, 1920 x 1080p @ 59.99 Hz, Audio @ 44.1 kHz, 16 bits Stereo, Enabled (needs signal), YUV 4:2:0 8 bits, EDID pass through: Enabled.
- Line In 1 (H):** Analog Audio Input 1, no connection detected, Enabled (needs signal).
- Line In 2:** Analog Audio Input 2, no connection detected, Enabled (needs signal).
- Microphone (I):** no connection detected, Enabled (needs signal), 44.1 kHz, 16-bit stereo.
- Headphone (J):** Volume: 0 dB.

A	Input number	Identifies the input (1 and 2).
B	Input name	Lists the name of the input, as specified by the user.
C	Video signal	Detects the resolution and refresh rate of the video signal. If no signal is detected, this reads as (no video) .
D	Audio signal	Detects the HDMI audio signal. If no signal is detected, this reads as (no audio) . If audio is disabled, this reads as (audio disabled) .
E	Status	Indicates if the input is enabled or disabled for capture.
F	Pixel format	Defines the quality of the image captured.
G	EDID pass through	Outputs the video and audio signals of your source directly to your monitor and audio output device.
H	Connection status	Detects if an analog audio device is connected. If no device is connected, this reads as (no connection detected) .
I	Sample rate	Lists the sample rate of the analog audio signal.
J	Volume	Detects the volume level of your device.

You can configure the following settings for your inputs and outputs.

Enable input	To use an input as a source, you need to enable it. HDMI inputs are enabled by default.
Assign button	Assign a module (HDMI input, Streams, Local preview, or Recordings) to a button on your MaeveX 6122 device (Button 1, Button 2, Button 3, or Button 4). Note: Before assigning a module, make sure that module is set to Enable . If you don't want to assign a button, select None .
Input name	Enter a name for each input.
Pixel format	The pixel format defines the quality of the image captured. YUV refers to the color format used to receive each block of bits in the video signal. The format is followed by the pixel depth used for each color in the image format. A higher YUV format and pixel depth provides a higher quality image and requires more resources to process.
Continue streaming on signal loss	Enable this option if you would like streaming to continue when signal is lost. Select an option under Audio format for the audio quality expected for your stream after a signal loss. If the audio is missing, or not in the format you select here, silence is generated. Note: When enabling this option, make sure to also select Continue streaming on signal loss for your stream under Processing (see "9.1.2 - Processing", page 113).
Disable EDID pass through	Output the video and audio signals of your source directly to your monitor and audio output device. To disable this feature, enable the Disable EDID pass through option.
Sample format	Specify the sampling rate, in kHz, and bit depth for your analog audio device.
Gain	Increase or decrease the amplitude, in dB (decibels), of your microphone.
Continue streaming when microphone is inserted or removed	Enable this option if the microphone analog audio signal is selected for your stream and you would like to have continuous streaming irrespective of microphone signal interruptions or disconnects. You need to also make sure that the Continue streaming on signal loss option is selected under Processing as well as Inputs/Outputs .
Volume	Increase or decrease the volume, in dB (decibels), of your headphones.

9.1.2 Processing

 **Note:** To view and edit the settings of a processing module, click that module. The information appears on the right side of the panel.

 **Note:** Depending on your configuration (for example, if you're using a single source layout), certain settings may not be available.

Select a processing to configure its source.

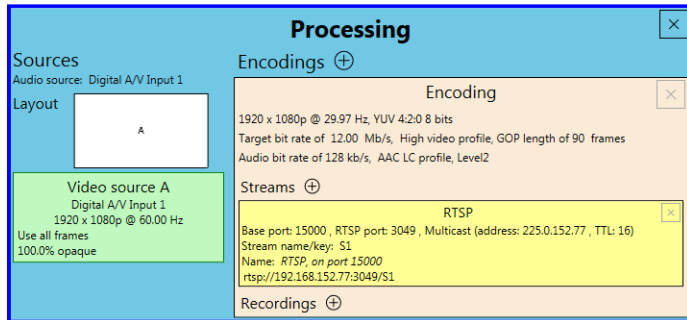

Audio source	The source of the audio signal to use.
Layout	The layout (picture in picture or picture by picture) and the number of sources to use.
Synchronize framelocked video input signal	Enable this to maintain frame synchronization when compositing from multiple sources (inputs).
Continue streaming on signal loss	Enable this to make sure streaming isn't interrupted if the source signal is switched or the connection to the device is lost. You can also set a background fill color for your composite layout. Note: When enabling this option, make sure to also select the Continue streaming on signal loss option for your stream under Inputs/Outputs (see "9.1.1 - Inputs/Outputs", page 111).
Frame size	The width and height, in pixels, of the source. If the layout of your sources uses a height or width that's smaller than your frame size, black borders may appear on both sides, or on the top and bottom, of the frame. The width ranges from 64 to 4096 and must be a multiple of 16. The height ranges from 64 to 4096 and must be an even number.
Frame rate	The frame rate, in FPS (frames per second), for the source.



Background color	The background color for your source. If the layout of your sources uses less height or width than your frame size, the borders will use the background color. If no video is captured for your source, the background color is shown instead.
Pixel format	The pixel format to define the quality of your image, and the pixel depth for each color in the image format. A higher YUV format and pixel depth provides a higher quality image and requires more resources to process. Only certain pixel formats may be available.

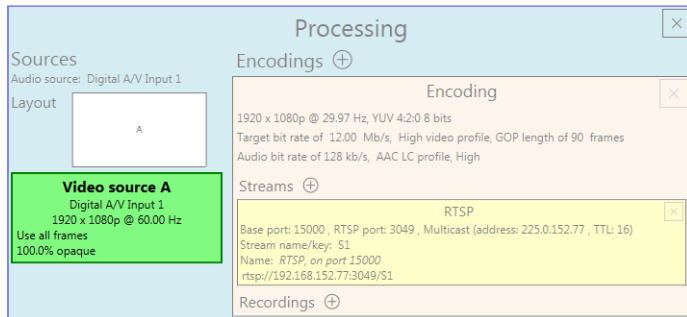

9.1.3 Source



Note: Depending on your configuration (for example, if you're using a single source layout), certain settings may not be available.

Input	Select the input to use for your source.
Capture rate	Select the frame rate for video capture. Reducing the frame rate also reduces the frame rate of the stream or recording. Note: When the incoming signal is at 4K60, the maximum is 4:2:2 encoding on a Maevex 6122 encoder.

<p>Scaling</p>	<p>Select how to scale your video:</p> <ul style="list-style-type: none"> ▪ Unscaled from top left – The video is unscaled and positioned in the top left corner of the display area. If the display resolution of the video is bigger than the display area, the video will be cropped. ▪ Unscaled centered – The video is unscaled and centered in the display area. If the display resolution of the video is bigger than the display area, the video will be cropped. ▪ Stretched to all edges – The video is stretched to fit the entire display area without respecting the aspect ratio of the original video. If the aspect ratio of the video and the display area don't match, the video may be distorted. ▪ Scaled to all edges – The video is scaled to fit the entire display area while respecting the aspect ratio of the original video. The video is centered in the display area. If the aspect ratio of the video and the display area don't match, the video will be cropped. ▪ Scaled to nearest edge – The video is scaled to fit to the display area while respecting the aspect ratio of the original video. The video is centered in the display area. If the aspect ratio of the video and the display area, black borders will appear on both sides of the video or above and below. The video isn't cropped.
<p>Pivot</p>	<p>Change the orientation of your source:</p> <ul style="list-style-type: none"> ▪ 0 degrees – No pivot is applied. ▪ 90 degrees clockwise – The source is rotated 90 degrees clockwise. ▪ 180 degrees – The source is rotated 180 degrees. ▪ 90 degrees counterclockwise – The source is rotated 90 degrees counterclockwise.
<p>Flip</p>	<p>Select the plane along which the source is flipped:</p> <ul style="list-style-type: none"> ▪ None – No flip is applied. ▪ Vertically – The source is flipped along the vertical plane. The top becomes the bottom. ▪ Horizontally – The source is flipped along the horizontal plane. The right side becomes the left. ▪ On both axes – The source is flipped along the vertical plane and the horizontal plane. This is visually similar to rotating 180 degrees.
<p>Opacity</p>	<p>Increase or decrease how opaque the source video appears. The default is 100%. </p>
<p>Brightness</p>	<p>Increase or decrease how light or dark the colors appear. The default is 500. </p>

Contrast	Change the difference in brightness between the lightest and darkest colors. The default is 500. 
Hue	Increase or decrease the tint or tone of colors. The default is 0. 
Saturation	Increase or decrease the depth of the colors. The default is 500. 

9.1.4 Encodings

These settings determine how your processor encodes, transmits, or records the video and audio signals.

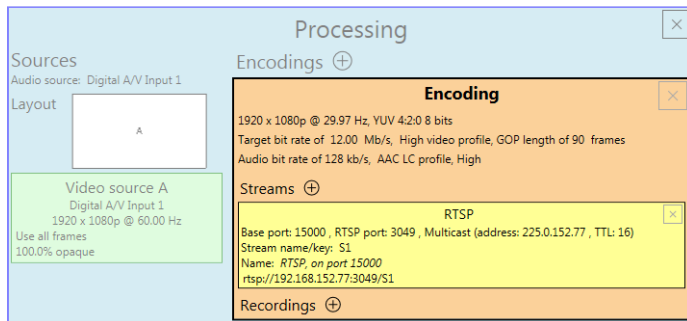

9.1.4.1 Adding an encoding

To add an encoding:

- **Custom encoding** – Click the **Add** (⊕) icon, then click **To Custom**. Enter the information for the selected protocol. The default is **RTMP**.
- **Content delivery network (CDN)** – Click the **Add** (⊕) icon, then click a preset (**Facebook Live**, **YouTube**, **Restream**, **Twitch**, **IBM Video Streaming**, **Vimeo**, or **Wowza Cloud**). Enter the information for the selected protocol.

9.1.4.2 Include

Select the signals to include (**Audio only**, **Video only**, or **Audio and video**) in your encoding.

9.1.4.3 Force encoding size

Enable this to have PowerStream Plus increase or reduce the captured video size before it's encoded.

Frame size	Specify the width and height, in pixels, of the video up to the width and height of the original video input. If your video source uses a different size, your encoder scales the video to the specified size (image may be distorted). The width ranges from 64 to 4096 and must be a multiple of 16. The height ranges from 64 to 4096 and must be an even number.
Scaling	Select how to scale your video: <ul style="list-style-type: none">▪ Unscaled from top left – The video is unscaled and positioned in the top left corner of the display area. If the display resolution of the video is bigger than the display area, the video will be cropped.▪ Unscaled centered – The video is unscaled and centered in the display area. If the display resolution of the video is bigger than the display area, the video will be cropped.▪ Stretched to all edges – The video is stretched to fit the entire display area without respecting the aspect ratio of the original video. If the aspect ratio of the video and the display area don't match, the video may be distorted.▪ Scaled to all edges – The video is scaled to fit the entire display area while respecting the aspect ratio of the original video. The video is centered in the display area. If the aspect ratio of the video and the display area don't match, the video will be cropped.▪ Scaled to nearest edge – The video is scaled to fit to the display area while respecting the aspect ratio of the original video. The video is centered in the display area. If the aspect ratio of the video and the display area, black borders will appear on both sides of the video or above and below. The video isn't cropped.
Pivot	Change the orientation of your source: <ul style="list-style-type: none">▪ 0 degrees – No pivot is applied.▪ 90 degrees clockwise – The source is rotated 90 degrees clockwise.▪ 180 degrees – The source is rotated 180 degrees.▪ 90 degrees counterclockwise – The source is rotated 90 degrees counterclockwise.

Flip	<p>Select the plane along which the source is flipped:</p> <ul style="list-style-type: none"> ▪ None – No flip is applied. ▪ Vertically – The source is flipped along the vertical plane. The top becomes the bottom. ▪ Horizontally – The source is flipped along the horizontal plane. The right side becomes the left. ▪ On both axes – The source is flipped along the vertical plane and the horizontal plane. This is visually similar to rotating 180 degrees.
-------------	---

9.1.4.4 Force pixel format

The pixel format defines the quality of the image encoded. YUV refers to the color format used to receive each block of bits in the video signal. The format is followed by the pixel depth used for each color in the image format. A higher YUV format and pixel depth provides a higher quality image and requires more resources to process.

9.1.4.5 Encoding profile

Encoding profile	<p>Select an encoding profile for your signal. Changing the encoding profile may prevent your decoder from streaming. Select one of the following:</p> <ul style="list-style-type: none"> ▪ Baseline ▪ Main ▪ High ▪ High, 10-bit ▪ High, YUV 4:2:2 ▪ High, YUV 4:4:4 Predictive ▪ High, YUV 4:4:4 CAVLC + Intra
Target bit rate	<p>The target bit rate, in Mb/s (Megabits per second), for encoding. The actual bandwidth used by your encoder varies according to your source and encoding method. The default is 15 Mb/s. A lower target bit rate may result in lower image quality. A higher target bit rate limit may result in lower performance, a higher bandwidth when streamed, and a larger file size when recorded.</p>
Bit rate control	<p>Select one of the following:</p> <ul style="list-style-type: none"> ▪ Use a variable bit rate ▪ Use a constant bit rate
Maximum bit rate	<p>The maximum bit rate for encoding. When encoding, the processor attempts to use the target bit rate but may use up to the maximum bit rate specified. The default is 22.5 Mb/s. The maximum bit rate is 120 Mb/s.</p>

Estimated H.264 level	The estimated level of support for a profile required from the decoder.
Quantization parameters	The range used to compress the various frames in your GOP. A high maximum increases the level of compression of the frame and should decrease the bit rate but may decrease the image quality.

9.1.4.6 Encoding mode

Optimized for low latency	Reduces the delay between the time the video is captured on the encoder and the time it's shown on a monitor connected to a decoder.
Optimized for desktop	Provides a better image quality for static images (such as a computer desktop). Note: It is recommended to use the Optimized for desktop mode with the Use a variable bit rate option, with the Maximum bit rate set to at least twice the Target bit rate .
Favor image quality	Favors image quality over latency, but may require more delay.

9.1.4.7 Force CAVLC entropy encoding

Enable this to force the use of context adaptive variable length coding (CAVLC) entropy encoding. Enabling this option overrides the default entropy encoding selection (CABAC).

9.1.4.8 Group of pictures (GOP)

GOP length	The number of frames from one complete frame (I-frame) to another. A higher GOP length increases the compression level but may result in a lower quality image. The default is 90.
Insert P-frames every X frames	Enter the number of frames before a P-frame is inserted. All other frames are B-frames. A higher number of frames before inserting a P-frame increases the quality of the image but may result in a loss of performance. The minimum and default value is 1. The maximum value is 4.

9.1.5 Audio

Bit rate	Select the audio bit rate, in kbps, for your audio transmission. A higher bit rate produces a sound quality closer to the source quality, but requires more bandwidth. The value ranges from 32 to 576. The default is 128.
AAC encoder	Select one of the following: <ul style="list-style-type: none">▪ AAC LC – Allowed bit rate range is 32 to 576 kbps.▪ AAC HEv1 – Allowed bit rate range is 32 to 288 kbps.▪ AAC HEv2 – Allowed bit rate range is 32 to 144 kbps.
AAC quality	Force the use of encoding complexity (low to high) to improve the quality of compressed audio. Adjusting these settings doesn't affect the audio sample rate, target bit rate, or latency. <ul style="list-style-type: none">▪ Low▪ Medium▪ High
Use temporal noise shaping	This reshapes the quantization noise over time to improve the quality of the audio signal. This option is enabled by default.
AAC format	Select one of the following: <ul style="list-style-type: none">▪ ADTS▪ No container format

9.1.6 Streams

To add a stream (**RTP**, **RTMP**, **RTSP**, **SRT**, **MPEG-2 TS**, or **HLS**), click the **Add** (+) icon.

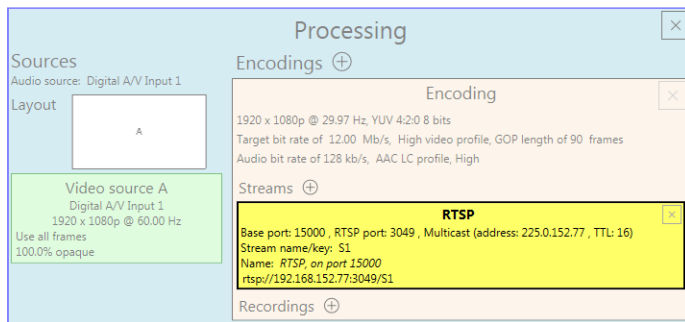

Note: If you configured your encoder to use **IPv4 and IPv6**, you must enable one stream for IPv4 and one stream for IPv6.



Note: To receive an RTP stream, you need to create an SDP file. For more information, contact Matrox Technical Support.



Note: When applying settings to multiple devices, make sure static IP addresses and multicast addresses aren't being duplicated. For more information, contact your network administrator.



Note: Depending on the stream selected, certain options aren't available.

Enable stream	Enable or disable your stream.
Assign button	Assign a module (HDMI input, Streams , Local preview , or Recordings) to a button on your MaeveX 6122 device (Button 1 , Button 2 , Button 3 , or Button 4). Note: Before assigning a module, make sure it's set to Enable . If you don't want to assign a button, select None .
Stream address	RTSP only – The URL (or stream address) of your RTSP stream.
Base port	The port number used to transmit your stream.
Destination location	RTMP only – The path of your RTMP stream.
Playlist file name	HLS only – Enter the name of your playlist file.
Name	Enter a name for your stream.
Network interface	The network interface (LAN1 or LAN2) to use for the stream. To use the first IP address the device finds, select Automatic IPv4 to use an IPv4 address or Automatic IPv6 to use an IPv6 address.
Encoding ladder configuration	HLS only – Select how to configure the encoding ladder: <ul style="list-style-type: none"> ▪ Manual – Specify the bit rate and FPS (frames per second) decimation, then select the ladder to Enable for the HLS stream. To show resolutions that are automatically generated, enable Show auto-generated resolutions from video signal. ▪ Automatic – Specify the Number of steps (1 to 6, with 1 being the highest bit rate) in the encoding ladder.
RTSP port	RTSP only – The RTSP port number used to transmit your stream.
Stream name/key	RTMP and RTSP only – Enter a suffix as part of your stream address. If you're using a media player to decode your stream, the media player may require this as part of the stream address to connect to a stream.
Use authentication	RTMP and RTSP only – Enable this if you're using an authentication server, then enter your credentials (User name and Password).

Encryption	SRT only – The encryption level to secure your stream. Options include: Unencrypted , AES-128 , AES-192 , or AES-256 .
Passphrase	The passphrase used to generate the encryption key. We recommend a passphrase length of 16 characters (AES-128), 24 characters (AES-192), and 32 characters (AES-256). If Unencrypted is selected, there's no passphrase to enter.
Connection type	SRT only – Run SRT in Caller , Listener , or Rendezvous mode.
Latency	SRT only – The target latency, in milliseconds (ms), for transmission. The default is 40 ms.
Time to live (TTL)	The number of hops or network nodes (such as network switches or routers) through which a multicast signal can travel. Once the TTL number is reached, the receiving network node prevents the signal broadcast further down the network. The value ranges from 1 to 255. The default is 16.
Type of service	Set a value between 0 and 255 for the type of service (priority level) for outgoing network packets (except for the RTMP and HLS protocols). The default value is 0.
Routing scheme	<ul style="list-style-type: none"> ▪ Unicast – When selecting unicast, you need to specify the destination IP address of the stream. You can enter a valid IP address or host name. ▪ Multicast – Enter a Multicast address. Using multicast may require additional network configuration to support the transmission protocol (some network switches and routers can block multicast signals). For more information, contact your network administrator. To also allow unicast connections, enable the Allow unicast connections option.

9.1.7 Recordings

Use this option to record your video files on a network attached storage (NAS) device or an external storage device. The video files created are encoded with an H.264 video and AAC audio codec.

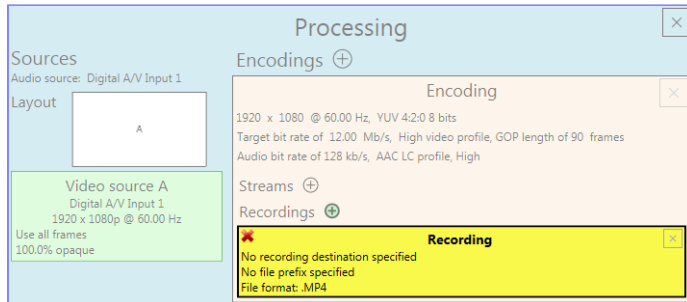

Note: When starting a recording manually or through a scheduled recording, it may take a few seconds for your encoder to actually record video. When scheduling a recording, we recommend you start the recording earlier than the actual time required.

Note: If your network is slow, congested, or experiencing high traffic, your recording may fail. For more information, contact your network administrator.

9.1.7.1 Enable recording

Enable this to be able to record from your device.

If **Scheduled recording** is enabled, this option isn't available.

9.1.7.2 Assign button

Assign a module (**HDMI input**, **Streams**, **Local preview**, or **Recordings**) to a button on your MaeveX 6122 device (**Button 1**, **Button 2**, **Button 3**, or **Button 4**).

Note: Before assigning a module, make sure it's set to **Enable**.

If you don't want to assign a button, select **None**.

9.1.7.3 File name prefix

The video file name is made up of two parts:

- **First part** – The name, which you enter.
- **Second part** – The timestamp of when the video file started, which your encoder defines.

The resulting file name is *Prefix[YYYY-MM-DD_HH-MM-SS].mp4*, where YYYY is the year, MM the month, DD the day, HH the hour (in a 24-hour format), MM the minutes, and SS the seconds.

A file name prefix can be up to 19 characters long.

9.1.7.4 File format

Select the format for your recording (MP4 or MOV).

To use fragmented MP4, enable the **Use fragmented MP4 (fMP4)** option. This option ensures your recorded file won't be corrupted in the event your network connection is disrupted.

9.1.7.5 Maximum file block duration

Enter the recording time for each video file recorded. Once the recording time for a file is reached, PowerStream Plus creates a new file. A file can hold up to 8 hours of recording.

If the sampling rate (audio or video) changes, a new file is created, regardless of the file duration.

9.1.7.6 Recording location

Under **Record to**, provide the path to the existing network shared folder or select the external storage device where your video files will be stored.



Note: To make sure the network path is properly recognized by your device, we recommend you provide the full computer name or the IP address of the system where the shared folder is located. The full computer name is part of the Windows properties of the system. For example, the full computer name of network server may be *networkserver.domain.com*. For more information, contact your network administrator.

9.1.7.6.1 Add network shared folder

Enter the path to the existing network shared folder, then select how to connect to the shared folder:

- **Connect as guest** – If your network drive doesn't require user identification, use this. When you're done, click **OK**.
- **Connect with credentials** – If your network drive requires user identification, enter a **User name** and **Password**. **Note:** Include the domain in the **User name** field in one of the following formats: PCNAME\USER, USER@PCNAME, or USER@DOMAIN. When you're done, click **OK**.

9.1.7.6.2 Manage network shared folders

Use this to review your list of credentials, and to remove user names and passwords that are no longer required.

9.1.7.6.3 Eject device

To safely remove an external storage device from your system, select the device you want to remove, then click the **Eject** () button.

9.1.7.7 Scheduled recording

Enable this to schedule a date, time, and duration for your encoder to record a video file.

Start recording at	Enter the date and time to start recording.
Stop recording at	Enter the date and time to stop recording.

9.2 Network

This contains the network settings for the connection and IP address of your encoder.

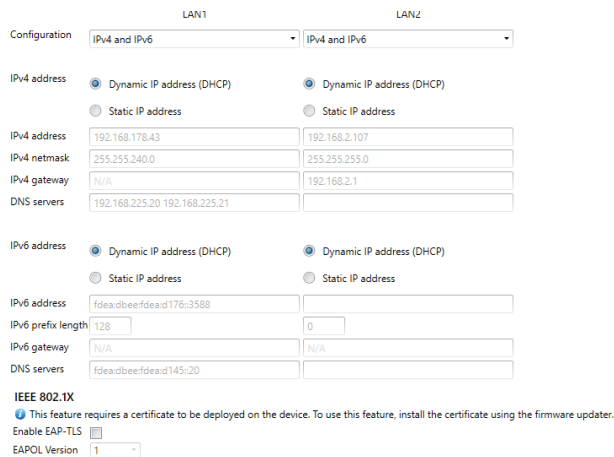

The screenshot shows the Network Configuration page with two columns for LAN1 and LAN2. Each column has a dropdown for 'Configuration' set to 'IPv4 and IPv6'. Under 'IPv4 address', both are set to 'Dynamic IP address (DHCP)'. For LAN1, the IPv4 address is 192.168.178.43, netmask is 255.255.240.0, gateway is N/A, and DNS servers are 192.168.225.20 and 192.168.225.21. For LAN2, the IPv4 address is 192.168.2.107, netmask is 255.255.255.0, gateway is 192.168.2.1, and DNS servers are empty. Under 'IPv6 address', both are set to 'Dynamic IP address (DHCP)'. For LAN1, the IPv6 address is fdeadbeefdead176:3588, prefix length is 128, gateway is N/A, and DNS servers are fdeadbeefdead145:20. For LAN2, the IPv6 address is empty, prefix length is 0, gateway is N/A, and DNS servers are empty. At the bottom, there is a section for 'IEEE 802.1X' with a note that it requires a certificate, and 'Enable EAP-TLS' is unchecked with 'EAPOL Version' set to 1.

9.2.1 Configuration

Select if you want to configure your device to support **IPv4**, **IPv6**, or **IPv4 and IPv6**.

9.2.2 IP address

Select how to assign an IP address to your encoder.

By default, **Dynamic IP address (DHCP)** is used. For information on manually assigning a **Static IP address**, see “3.1 - Network discovery”, page 20.

9.2.3 IEEE 802.1X EAP-TLS

The 802.1X is a standard used to control access to a network for devices and PCs. Maevex uses the EAP-TLS protocol used by 802.1X to securely identify a device prior to its authorization to join the network.

The **IEEE 802.1X** sub-section becomes available only after the certificates necessary for 802.1X are uploaded via the firmware updater. For more information, refer to the *Store a certificate file on the device for IEEE 802.1X EAP-TLS* topic in your Matrox Maevex Series Firmware Updater document.

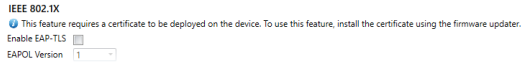

When you enable the **Enable EAP-TLS** option, you need to choose the **EAPOL version** from the drop-down list.



Note: The EAPOL version information will be provided along with the certificates by your IT department (in charge of the network where 802.1X is used).

For more information, see [“8.2.3.1 - Configure a device for deployment on a 802.1X EAP-TLS network”](#), page 105.

9.3 RS232

Enable this to virtualize an RS232 (or serial) connection.

9.3.1 Enabling RS232 virtualization

To enable RS232 virtualization, select the type of RS232 connection to use.

Disabled	Disable RS232 to close the TCP port used for virtualization.
-----------------	--

Relayed serial over IP	In a relayed connection, the physical RS232 controller must be connected to your encoder to send commands to an RS232 device that's connected to a decoder. The RS232 connection is independent of any other connection between an encoder and a decoder. When using this option, the RS232 settings of your encoder are sent to the decoder. To establish a relayed connection, the encoder and the decoder must both use Relayed serial over IP .
Direct serial over IP	In a direct connection, an IP-based RS232 controller application can send commands directly to the RS232 device connected to your encoder. The RS232 controller isn't physically connected to a device. Any encoder that uses direct serial over IP receives the RS232 commands through an opened TCP port (for example, from a telnet session) and sends these commands to the third-party RS232 device connected to it.
Local control	Select this to add local encoder device control through the RS232 interface.

9.3.2 Configuring RS232

Select decoder	If Relayed serial over IP is selected, select the decoder that's connected to the RS232 device you want to communicate with. The RS232 connection is virtualized only between your encoder and this decoder. This setting isn't available if Direct serial over IP is selected.
TCP port	If Direct serial over IP is selected, select which port will receive the RS232 commands. (Make sure the port number is available and not used by another service on your network.) The default is 11999. This setting isn't available if Relayed serial over IP is selected.
RS232 settings	If Relayed serial over IP is selected, the following settings are used by the encoder and the selected decoder. If Direct serial over IP is selected, the following settings are used only for the device connected to your encoder. <ul style="list-style-type: none"> ▪ Baud rate – The speed, in bits per seconds (or baud), used for the RS232 connection. The default is 115200. ▪ Data bits – The number of bits per block of data transmitted. The default is 8. ▪ Parity – The type of parity bits (None, Odd, or Even) used for the data transmitted. The default is None. ▪ Stop bits – The number of bits used to identify the end of a data block. The default is 1. ▪ Flow control – The signal type (None or RTS/CTS) used to pause and resume data transmission. The default is None.

9.4 Date and time

Use this to update the date, time, and time zone of your Maevox device. For more information on these settings, see “14 - Adjusting the date and time of your device”, page 169.

9.5 Other

This contains the settings for protected content support (security), local preview, power recovery policy, power button control, reboot control, Wake-on-LAN control, DNS update, audits, logs, and troubleshooting.

The screenshot displays the 'Other' settings page for a Maevox device. The settings are organized into several sections:

- Local preview:** Includes a checkbox for 'Enable local preview of input', a 'Video source' dropdown menu, a 'Title' input field, a 'Cycle duration' spinner set to 3 seconds, an 'Assign button' dropdown set to 'Button 1', and an 'Audio source' dropdown set to 'None'.
- Power recovery policy:** A dropdown menu set to 'Always start'.
- Power button control:** A checkbox for 'Disable shutdown'.
- Reboot control:** A checked checkbox for 'Enable force reboot'.
- Wake-on-LAN control:** A checked checkbox for 'Enable Wake-on-LAN'.
- DNS update:** A checkbox for 'Update DNS with friendly name'.
- Logs:** Contains two buttons: 'Download device logs' and 'Erase device logs'.
- Audits:** Contains one button: 'Download device audits'.
- Security:** A checkbox for 'Enable copy protection (HDCP) support'.
- Troubleshooting:** Includes a section for 'Audio' with a 'Disable audio' checkbox, and a 'Debug configurations' link with a dropdown arrow.

Local preview	<p>To preview your sources on your console display, enable the Enable local preview of input option, then select your Video source:</p> <ul style="list-style-type: none"> ▪ Input – Input stream appears full-screen. ▪ Tile – Input streams appear as a tile view. ▪ Cycle – Input streams cycle. Specify the Cycle duration, in seconds. <p>To assign the local preview to a button on your Maevox 6122 device (Button 1, Button 2, Button 3, or Button 4). If you don't want to assign a button, select None.</p> <p>If the option is enabled, select an Audio source from the list. If no input is available, None appears.</p>
Power recovery policy	<p>Set up your Maevox device to start up after a power loss.</p> <ul style="list-style-type: none"> ▪ Never start – Never start your Maevox device after a power loss. ▪ Always start – Always start your Maevox device after a power loss. ▪ Restore last state – Always start and restore the last state of your Maevox device after a power loss.
Power button control	<p>To prevent your device from shutting down, enable the Disable shutdown option.</p>
Recording control	<p>To disable the recording module for a specific Maevox device, enable the Disable recording option. Your device will reboot for this change to take effect.</p>
Reboot control	<p>To remotely force a reboot of your device if it stops responding, enable the Enable force reboot option.</p>
Wake-on-LAN control	<p>To remotely reboot an unresponsive Maevox device, enable the Enable Wake-on-LAN option.</p>
DNS update	<p>To update your DNS (Domain Name System) to use a friendly name instead of the device serial number, enable the Update DNS with friendly name option.</p>
Logs	<ul style="list-style-type: none"> ▪ Download device logs – Download the log files. This file contains information on your Maevox devices. This information is useful for troubleshooting purposes. ▪ Erase device logs – Erase the log files created for your Maevox devices.
Audits	<p>Download the audit file. When you click Download device audits, you'll be prompted to enter a password. The password entered encrypts the audit file.</p> <p>This file contains information on the user interactions with your Maevox devices. This information is used by your Maevox environment administrator.</p>

<p>Troubleshooting</p>	<ul style="list-style-type: none"> ▪ Audio – To disable the audio on all of your MaeveX 6100 Series devices, enable the Disable audio option. Your device will reboot for this change to take effect. ▪ Debug configurations – Get help and troubleshooting information for your configuration. For more information, contact Matrox Technical Support.
<p>Security</p>	<p>The Enable copy protection (HDCP) support option is applicable to the MaeveX 6122 encoder. Select the checkbox to capture protected content over any of the HDMI inputs and decode it with the MaeveX 6152 decoder.</p> <ul style="list-style-type: none"> ▪ All local HDMI outputs must use HDCP-capable displays, otherwise they are blank. ▪ When the Enable copy protection (HDCP) support option is enabled, the DisplayPort console output as well as the recording function are not supported. ▪ RTSP or RTP protocol must be used (HLS, SRT, RTMP, and MPEG-2 TS protocols are not supported for streaming of protected content). Note: If the DisplayPort console output, an unsupported streaming protocol, or the recording function is currently in use, you will not be able to enable the Enable copy protection (HDCP) support option and the following error message will display “<i>There is a streaming protocol or a recording in the processing section that is not compatible with HDCP.</i>” ▪ Any source content can be displayed on a maximum of 32 remote displays with HDCP support. Note: Third party HDMI / HDCP splitters connected to a MaeveX 6122 decoder output will count as multiple display destinations, depending on the nature of the device and the number of displays connected to it. The use of such devices could quickly reduce the number of decoder outputs allowed to carry any given content originating from any encoder that is enabled for protected content support (Enable copy protection (HDCP) support option is enabled). ▪ Any content streamed by a MaeveX 6122 (or MaeveX 6152) encoder with copy protection (HDCP) support enabled, including non-HDCP-protected content received from HDMI sources, can only be decoded by a MaeveX 6152 decoder which also has the Enable copy protection (HDCP) support option enabled and the protocol used is RTSP or RTP (MPEG-2 TS, HLS, RTMP, and SRT protocols don't support streaming of protected content).

	<p>A Maevox 6122 encoder with the Enable copy protection (HDCP) support option disabled will not capture and process any protected content from any source.</p> <p>Note: When you select Enable copy protection (HDCP) support and click Apply, you will receive a confirmation message saying that you need to reboot the device for the change to take effect. Every output with a non-HDCP device connected will be disabled.</p>
--	--

10 Maevox 6100 encoder settings

This enables you to view, configure, and manage settings specific to a Maevox 6100 Quad encoder.



Note: Don't change input or network connections while your Maevox device is turned on. If connections are changed while your Maevox device is turned on, your video sources or recordings will be lost.

10.1 Processing

10.1.1 Inputs

An input box contains the following information about the video and audio signal detected by your encoder.

HDMI 1	HDMI 2	HDMI 3	HDMI 4
A HDMI 1	HDMI 2	HDMI 3	HDMI 4
B Digital A/V Input 1	Digital A/V Input 2	Digital A/V Input 3	Digital A/V Input 4
C 1920 x 1080p @ 60.01 Hz Audio @ 48.0 kHz, 16 bits Stereo	D 3840 x 2160p @ 60.01 Hz Audio @ 48.0 kHz, 16 bits Stereo	1920 x 1080i @ 30.00 Hz Audio @ 48.0 kHz, 16 bits Stereo	720 x 480p @ 59.94 Hz (no audio)
Enabled YUV 4:2:0 8 bits	Enabled YUV 4:2:0 8 bits	E Enabled YUV 4:2:0 8 bits	Enabled YUV 4:2:0 8 bits F

A	Input number	Identifies the input (1, 2, 3, and 4).
B	Input name	Lists the name of the input, as specified by the user.
C	Video signal	Detects the resolution and refresh rate of the video signal. If no signal is detected, this reads as (no video) .
D	Audio signal	Detects the audio signal. If no signal is detected, this reads as (no audio) . If audio is disabled, this reads as (audio disabled) .
E	Status	Indicates if the input is enabled or disabled for capture.
F	Pixel format	Defines the quality of the image captured.

You can configure the following settings for each input.

Enable input	To use an input as a source, you need to enable it. Inputs are enabled by default.
Input name	Enter a name for each input.

Pixel format	The pixel format defines the quality of the image captured. YUV refers to the color format used to receive each block of bits in the video signal. The format is followed by the pixel depth used for each color in the image format. A higher YUV format and pixel depth provides a higher quality image and requires more resources to process.
Expected audio quality	The audio quality expected for your stream. Note: When enabling this option, make sure to also select Continue streaming on signal loss for your stream (see “10.1.2 - Processing”, page 133).

10.1.2 Processing



Note: To view and edit the settings of a processing module, click that module. The information appears on the right side of the panel.



Note: Depending on your configuration (for example, if you’re using a single source layout), certain settings may not be available.

Select a processing to configure its source.

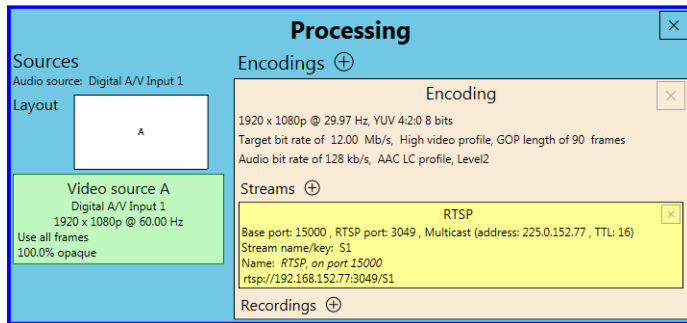

Audio source	The source of the audio signal to use.
Layout	The layout (picture in picture or picture by picture) and the number of sources to use.
Synchronize framelocked video input signal	Enable this to maintain frame synchronization when compositing from multiple sources (inputs).



Continue streaming on signal loss	Enable this to make sure streaming isn't interrupted if the source signal is switched or the connection to the device is lost. You can also set a background fill color for your composite layout. Note: When enabling this option, make sure to also select Expected audio quality for your stream (see "10.1.1 - Inputs", page 132).
Frame size	The width and height, in pixels, of the source. If the layout of your sources uses a height or width that's smaller than your frame size, black borders may appear on both sides, or on the top and bottom, of the frame. The width ranges from 64 to 4096 and must be a multiple of 16. The height ranges from 64 to 4096 and must be an even number.
Frame rate	The frame rate, in FPS (frames per second), for the source.
Background color	The background color for your source. If the layout of your sources uses less height or width than your frame size, the borders will use the background color. If no video is captured for your source, the background color is shown instead.
Pixel format	The pixel format to define the quality of your image, and the pixel depth for each color in the image format. A higher YUV format and pixel depth provides a higher quality image and requires more resources to process. Only certain pixel formats may be available.

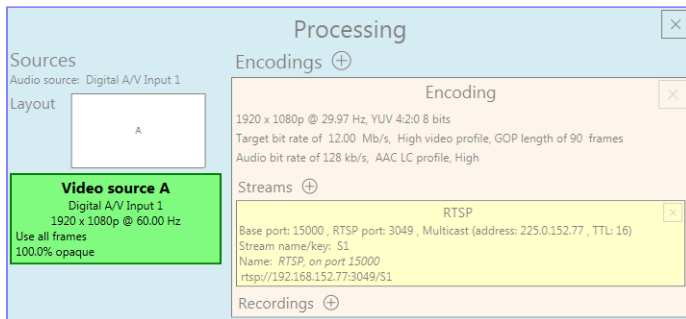

10.1.3 Source



Note: Depending on your configuration (for example, if you're using a single source layout), certain settings may not be available.

Input	Select the input to use for your source.
Capture rate	Select the frame rate for video capture. Reducing the frame rate also reduces the frame rate of the stream or recording.

<p>Scaling</p>	<p>Select how to scale your video:</p> <ul style="list-style-type: none"> ▪ Unscaled from top left – The video is unscaled and positioned in the top left corner of the display area. If the display resolution of the video is bigger than the display area, the video will be cropped. ▪ Unscaled centered – The video is unscaled and centered in the display area. If the display resolution of the video is bigger than the display area, the video will be cropped. ▪ Stretched to all edges – The video is stretched to fit the entire display area without respecting the aspect ratio of the original video. If the aspect ratio of the video and the display area don't match, the video may be distorted. ▪ Scaled to all edges – The video is scaled to fit the entire display area while respecting the aspect ratio of the original video. The video is centered in the display area. If the aspect ratio of the video and the display area don't match, the video will be cropped. ▪ Scaled to nearest edge – The video is scaled to fit to the display area while respecting the aspect ratio of the original video. The video is centered in the display area. If the aspect ratio of the video and the display area, black borders will appear on both sides of the video or above and below. The video isn't cropped.
<p>Pivot</p>	<p>Change the orientation of your source:</p> <ul style="list-style-type: none"> ▪ 0 degrees – No pivot is applied. ▪ 90 degrees clockwise – The source is rotated 90 degrees clockwise. ▪ 180 degrees – The source is rotated 180 degrees. ▪ 90 degrees counterclockwise – The source is rotated 90 degrees counterclockwise.
<p>Flip</p>	<p>Select the plane along which the source is flipped:</p> <ul style="list-style-type: none"> ▪ None – No flip is applied. ▪ Vertically – The source is flipped along the vertical plane. The top becomes the bottom. ▪ Horizontally – The source is flipped along the horizontal plane. The right side becomes the left. ▪ On both axes – The source is flipped along the vertical plane and the horizontal plane. This is visually similar to rotating 180 degrees.
<p>Opacity</p>	<p>Increase or decrease how opaque the source video appears. The default is 100%. </p>
<p>Brightness</p>	<p>Increase or decrease how light or dark the colors appear. The default is 500. </p>

Contrast	Change the difference in brightness between the lightest and darkest colors. The default is 500. 
Hue	Increase or decrease the tint or tone of colors. The default is 0. 
Saturation	Increase or decrease the depth of the colors. The default is 500. 

10.1.4 Encodings

These settings determine how your processor encodes, transmits, or records the video and audio signals.

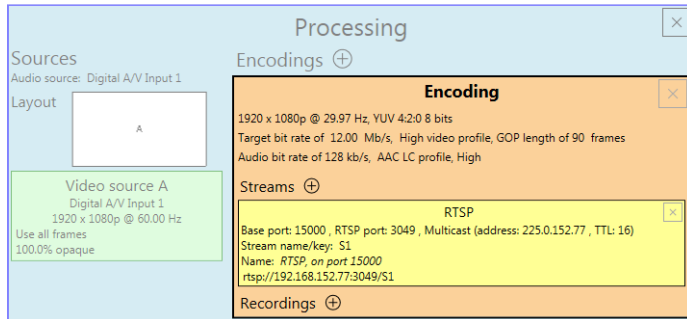

10.1.4.1 Adding an encoding

To add an encoding:

- **Custom encoding** – Click the **Add** (⊕) icon, then click **To Custom**. Enter the information for the selected protocol. The default is **RTMP**.
- **Content delivery network (CDN)** – Click the **Add** (⊕) icon, then click a preset (**Facebook Live**, **YouTube**, **Restream**, **Twitch**, **IBM Video Streaming**, **Vimeo**, or **Wowza Cloud**). Enter the information for the selected protocol.

10.1.4.2 Include

Select the signals to include (**Audio only**, **Video only**, or **Audio and video**) in your encoding.

10.1.4.3 Force encoding size

Enable this to have PowerStream Plus increase or reduce the captured video size before it's encoded.

Frame size	<p>Specify the width and height, in pixels, of the video up to the width and height of the original video input. If your video source uses a different size, your encoder scales the video to the specified size (image may be distorted).</p> <p>The width ranges from 64 to 4096 and must be a multiple of 16. The height ranges from 64 to 4096 and must be an even number.</p>
Scaling	<p>Select how to scale your video:</p> <ul style="list-style-type: none">▪ Unscaled from top left – The video is unscaled and positioned in the top left corner of the display area. If the display resolution of the video is bigger than the display area, the video will be cropped.▪ Unscaled centered – The video is unscaled and centered in the display area. If the display resolution of the video is bigger than the display area, the video will be cropped.▪ Stretched to all edges – The video is stretched to fit the entire display area without respecting the aspect ratio of the original video. If the aspect ratio of the video and the display area don't match, the video may be distorted.▪ Scaled to all edges – The video is scaled to fit the entire display area while respecting the aspect ratio of the original video. The video is centered in the display area. If the aspect ratio of the video and the display area don't match, the video will be cropped.▪ Scaled to nearest edge – The video is scaled to fit to the display area while respecting the aspect ratio of the original video. The video is centered in the display area. If the aspect ratio of the video and the display area, black borders will appear on both sides of the video or above and below. The video isn't cropped.
Pivot	<p>Change the orientation of your source:</p> <ul style="list-style-type: none">▪ 0 degrees – No pivot is applied.▪ 90 degrees clockwise – The source is rotated 90 degrees clockwise.▪ 180 degrees – The source is rotated 180 degrees.▪ 90 degrees counterclockwise – The source is rotated 90 degrees counterclockwise.

Flip	<p>Select the plane along which the source is flipped:</p> <ul style="list-style-type: none"> ▪ None – No flip is applied. ▪ Vertically – The source is flipped along the vertical plane. The top becomes the bottom. ▪ Horizontally – The source is flipped along the horizontal plane. The right side becomes the left. ▪ On both axes – The source is flipped along the vertical plane and the horizontal plane. This is visually similar to rotating 180 degrees.
-------------	---

10.1.4.4 Force pixel format

The pixel format defines the quality of the image encoded. YUV refers to the color format used to receive each block of bits in the video signal. The format is followed by the pixel depth used for each color in the image format. A higher YUV format and pixel depth provides a higher quality image and requires more resources to process.

10.1.4.5 Encoding profile

Encoding profile	<p>Select an encoding profile for your signal. Changing the encoding profile may prevent your decoder from streaming. Select one of the following:</p> <ul style="list-style-type: none"> ▪ Baseline ▪ Main ▪ High ▪ High, 10-bit ▪ High, YUV 4:2:2 ▪ High, YUV 4:4:4 Predictive ▪ High, YUV 4:4:4 CAVLC + Intra
Target bit rate	<p>The target bit rate, in Mb/s (Megabits per second), for encoding. The actual bandwidth used by your encoder varies according to your source and encoding method. The default is 15 Mb/s. A lower target bit rate may result in lower image quality. A higher target bit rate limit may result in lower performance, a higher bandwidth when streamed, and a larger file size when recorded.</p>
Bit rate control	<p>Select one of the following:</p> <ul style="list-style-type: none"> ▪ Use a variable bit rate ▪ Use a constant bit rate
Maximum bit rate	<p>The maximum bit rate for encoding. When encoding, the processor attempts to use the target bit rate but may use up to the maximum bit rate specified. The default is 22.5 Mb/s. The maximum bit rate is 120 Mb/s.</p>

Estimated H.264 level	The estimated level of support for a profile required from the decoder.
Quantization parameters	The range used to compress the various frames in your GOP. A high maximum increases the level of compression of the frame and should decrease the bit rate but may decrease the image quality.

10.1.4.6 Encoding mode

Optimized for low latency	Reduces the delay between the time the video is captured on the encoder and the time it's shown on a monitor connected to a decoder.
Optimized for desktop	Provides a better image quality for static images (such as a computer desktop). Note: It is recommended to use the Optimized for desktop mode with the Use a variable bit rate option, with the Maximum bit rate set to at least twice the Target bit rate .
Favor image quality	Favors image quality over latency, but may require more delay.

10.1.4.7 Force CAVLC entropy encoding

Enable this to force the use of context adaptive variable length coding (CAVLC) entropy encoding. Enabling this option overrides the default entropy encoding selection (CABAC).

10.1.4.8 Group of pictures (GOP)

GOP length	The number of frames from one complete frame (I-frame) to another. A higher GOP length increases the compression level but may result in a lower quality image. The default is 90.
Insert P-frames every X frames	Enter the number of frames before a P-frame is inserted. All other frames are B-frames. A higher number of frames before inserting a P-frame increases the quality of the image but may result in a loss of performance. The minimum and default value is 1. The maximum value is 4.

10.1.5 Audio

Bit rate	Select the audio bit rate, in kbps, for your audio transmission. A higher bit rate produces a sound quality closer to the source quality, but requires more bandwidth. The value ranges from 32 to 576. The default is 128.
AAC encoder	Select one of the following: <ul style="list-style-type: none"> ▪ AAC LC – Allowed bit rate range is 32 to 576 kbps. ▪ AAC HEv1 – Allowed bit rate range is 32 to 288 kbps. ▪ AAC HEv2 – Allowed bit rate range is 32 to 144 kbps.
AAC quality	Force the use of encoding complexity (low to high) to improve the quality of compressed audio. Adjusting these settings doesn't affect the audio sample rate, target bit rate, or latency. <ul style="list-style-type: none"> ▪ Low ▪ Medium ▪ High
Use temporal noise shaping	This reshapes the quantization noise over time to improve the quality of the audio signal. This option is enabled by default.
AAC format	Select one of the following: <ul style="list-style-type: none"> ▪ ADTS ▪ No container format

10.1.6 Streams

To add a stream (**RTP**, **RTMP**, **RTSP**, **SRT**, **MPEG-2 TS**, or **HLS**), click the **Add** (+) icon.

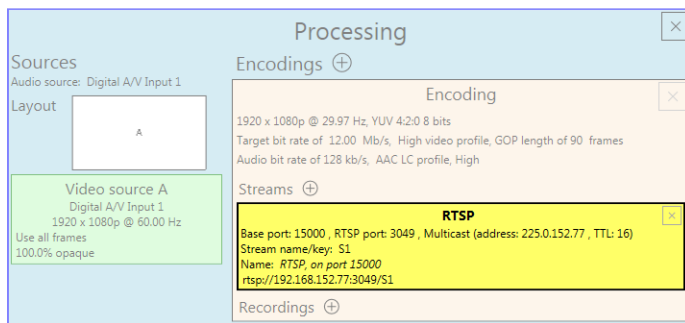

Note: If you configured your encoder to use **IPv4 and IPv6**, you must enable one stream for IPv4 and one stream for IPv6.



Note: To receive an RTP stream, you need to create an SDP file. For more information, contact Matrox Technical Support.



Note: When applying settings to multiple devices, make sure static IP addresses and multicast addresses aren't being duplicated. For more information, contact your network administrator.



Note: Depending on the stream selected, certain options aren't available.

Enable stream	Enable or disable your stream.
Stream address	RTSP only – The URL (or stream address) of your RTSP stream.
Base port	The port number used to transmit your stream.
Destination location	RTMP only – The path of your RTMP stream.
Playlist file name	HLS only – Enter the name of your playlist file.
Name	Enter a name for your stream.
Network interface	The network interface (LAN) to use for the stream. To use the first IP address the device finds, select Automatic IPv4 to use an IPv4 address, or Automatic IPv6 to use an IPv6 address.
Encoding ladder configuration	<p>HLS only – Select how to configure the encoding ladder:</p> <ul style="list-style-type: none"> ▪ Manual – Specify the bit rate and FPS (frames per second) decimation, then select the ladder to Enable for the HLS stream. To show resolutions that are automatically generated, enable Show auto-generated resolutions from video signal. ▪ Automatic – Specify the Number of steps (1 to 6, with 1 being the highest bit rate) in the encoding ladder.
RTSP port	RTSP only – The RTSP port number used to transmit your stream.
Stream name/key	RTMP and RTSP only – Enter a suffix as part of your stream address. If you're using a media player to decode your stream, the media player may require this as part of the stream address to connect to a stream.
Use authentication	RTMP and RTSP only – Enable this if you're using an authentication server, then enter your credentials (User name and Password).
Encryption	SRT only – The encryption level to secure your stream. Options include: Unencrypted , AES-128 , AES-192 , or AES-256 .

Passphrase	The passphrase used to generate the encryption key. We recommend a passphrase length of 16 characters (AES-128), 24 characters (AES-192), and 32 characters (AES-256). If Unencrypted is selected, there's no passphrase to enter.
Connection type	SRT only – Run SRT in Caller , Listener , or Rendezvous mode.
Latency	SRT only – The target latency, in milliseconds (ms), for transmission. The default is 40 ms.
Time to live (TTL)	The number of hops or network nodes (such as network switches or routers) through which a multicast signal can travel. Once the TTL number is reached, the receiving network node prevents the signal broadcast further down the network. The value ranges from 1 to 255. The default is 16.
Routing scheme	<ul style="list-style-type: none"> ▪ Unicast – When selecting unicast, you need to specify the destination IP address of the stream. You can enter a valid IP address or host name. ▪ Multicast – Enter a Multicast address. Using multicast may require additional network configuration to support the transmission protocol (some network switches and routers can block multicast signals). For more information, contact your network administrator. To also allow unicast connections, enable the Allow unicast connections option.

10.1.7 Recordings

Use this option to record your video files on a network attached storage (NAS) device. The video files created are encoded with an H.264 video and AAC audio codec.

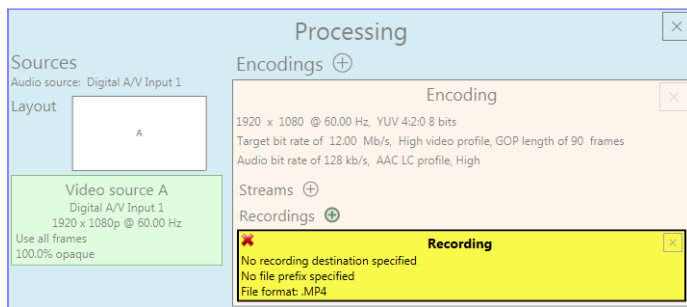

Note: When starting a recording manually or through a scheduled recording, it may take a few seconds for your encoder to actually record video. When scheduling a recording, we recommend you start the recording earlier than the actual time required.



Note: If your network is slow, congested, or experiencing high traffic, your recording may fail. For more information, contact your network administrator.

10.1.7.1 Enable recording

Enable this to be able to record from your device.

If **Scheduled recording** is enabled, this option isn't available.

10.1.7.2 File name prefix

The video file name is made up of two parts:

- **First part** – The name, which you enter.
- **Second part** – The timestamp of when the video file started, which your encoder defines.

The resulting file name is *Prefix[YYYY-MM-DD_HH-MM-SS].mp4*, where YYYY is the year, MM the month, DD the day, HH the hour (in a 24-hour format), MM the minutes, and SS the seconds.

A file name prefix can be up to 19 characters long.

10.1.7.3 File format

Select the format for your recording (MP4 or MOV).

To use fragmented MP4, enable the **Use fragmented MP4 (fMP4)** option. This option ensures your recorded file won't be corrupted in the event your network connection is disrupted.

10.1.7.4 Maximum file block duration

Enter the recording time for each video file recorded. Once the recording time for a file is reached, PowerStream Plus creates a new file. A file can hold up to 8 hours of recording.

If the sampling rate (audio or video) changes, a new file is created, regardless of the file duration.

10.1.7.5 Recording location

Under **Record to**, provide the path to the existing network shared folder or select the external storage device where your video files will be stored.



Note: To make sure the network path is properly recognized by your device, we recommend you provide the full computer name or the IP address of the system where the shared folder is located. The full computer name is part of the Windows properties of the system. For example, the full computer name of network server may be *networkserver.domain.com*. For more information, contact your network administrator.

10.1.7.5.1 Add network shared folder

Enter the path to the existing network shared folder, then select how to connect to the shared folder:

- **Connect as guest** – If your network drive doesn't require user identification, use this. When you're done, click **OK**.
- **Connect with credentials** – If your network drive requires user identification, enter a **User name** and **Password**. When you're done, click **OK**.

10.1.7.5.2 Manage network shared folders

Use this to review your list of credentials, and to remove user names and passwords that are no longer required.

10.1.7.6 Scheduled recording

Enable this to schedule a date, time, and duration for your encoder to record a video file.

Start recording at	Enter the date and time to start recording.
Stop recording at	Enter the date and time to stop recording.

10.2 Network

This contains the network settings for the connection and IP address of your encoder.

Configuration

IPv4 address Dynamic IP address (DHCP)
 Static IP address

IPv4 address
IPv4 netmask
IPv4 gateway
DNS servers

IPv6 address Dynamic IP address (DHCP)
 Static IP address

IPv6 address
IPv6 prefix length
IPv6 gateway

10.2.1 Configuration

Select if you want to configure your device to support **IPv4**, **IPv6**, or **IPv4 and IPv6**.

10.2.2 IP address

Select how to assign an IP address to your encoder.

By default, **Dynamic IP address (DHCP)** is used. For information on manually assigning a **Static IP address**, see “3.1 - Network discovery”, page 20.

10.3 Date and time

Use this to update the date, time, and time zone of your Maevox device. For more information on these settings, see “14 - Adjusting the date and time of your device”, page 169.

10.4 Other

Reboot control	To remotely force a reboot of your device if it stops responding, enable the Enable force reboot option.
Logs	<ul style="list-style-type: none">▪ Download device logs – Download the log files. This file contains information on your Maevox devices. This information is useful for troubleshooting purposes.▪ Erase device logs – Erase the log files created for your Maevox devices.
Audits	Download the audit file. When you click Download device audits , you’ll be prompted to enter a password. The password entered encrypts the audit file. This file contains information on the user interactions with your Maevox devices. This information is used by your Maevox environment administrator.
Troubleshooting	<ul style="list-style-type: none">▪ Audio – To disable the audio on all of your Maevox 6100 Series devices, enable the Disable audio option. Your device will reboot for this change to take effect.▪ Debug configurations – Get help and troubleshooting information for your configuration. For more information, contact Matrox Technical Support.

11 Maevox 5150 encoder settings

This enables you to view, configure, and manage settings specific to a Maevox 5150 encoder.

11.1 Processing

Enable processing

Capture

Stop capture if no HDMI input after seconds

Video

Input 1920 x 1080, 59.99 Hz
Use all frames

Audio

From HDMI
Sampling rate 48.0 kHz

Encoding

Video

Use specific video size x

Target bit rate Mb/s
Strategy Favor speed

Group of pictures (GOP)

GOP length

Use constant bit rate (CBR)
 Allow filling bits to sustain bit rate
 Use variable bit rate (VBR)

Insert P-frame every frames

Quantization parameters

Audio

Bit rate 192 kbps

Streaming / Recording

Stream to network

Stream address (Unicast and Multicast)
rtsp://192.168.154.184:3049/50
Port 3049
Folder 50

Multicast

Group address 224.2.0.1
Time to live 16

Record to network storage

Network shared folder

File name prefix
File duration 0 h 2 m 0 s
 Schedule recording
Start recording 2018.06.22 11:00
Total duration 0 h 1 m 0 s

11.1.1 Modify settings

To modify the settings for multiple devices at the same time:

- 1 From the PowerStream Plus main interface, press the [Ctrl] key, select the tiles of the devices you want to modify, then click **Multi-device settings**. The device tiles you select must be of the same type.
- 2 Enable the **Modify settings** option.
- 3 Select your preferred device, then make your changes.
- 4 When you're done, click **Apply**. This applies the settings from the preferred device to the other selected devices.

11.1.2 Enable processing

Click this to start or stop processing on your encoder.

11.1.3 Capture

These settings provide information for the video and audio signal received by your encoder and determine how these signals are processed for encoding.

11.1.3.1 Stop capture if no HDMI input

Enable this to stop capturing if a HDMI signal is no longer detected on the **HDMI In** connector of your encoder. When this feature is enabled, enter the minimum amount of time, in seconds, before the capture stops. Capture may take up to five (5) more seconds to stop once the HDMI signal is lost.

When capture stops, your encoder also stops streaming. The decoder connected to this encoder no longer receives a stream. The decoder can use the failsafe option (if enabled), or it can stop outputting to allow a monitor to enter power saving mode.

If this feature is disabled and the HDMI signal is lost, your encoder transmits a blank screen (blue) while no HDMI signal is received. The decoder connected to this encoder continues to receive a stream. In this case, the decoder can't use the failsafe option, so it will show a blank screen (blue), preventing a monitor from entering power saving mode.

Capture and streaming resume once the HDMI input is re-established.

11.1.3.2 Video

Input source display mode	The display mode received by the encoder. A display mode is a combination of display resolution and vertical refresh.
Capture rate	Select the frame rate for video capture. Reducing the frame rate also reduces the frame rate of the stream or recording. For interlaced input source display modes, your encoder captures all frames, regardless of the specified Capture rate .

11.1.3.3 Audio

Select the audio source to use for audio capture (**From HDMI** or **From analog input**). You can also disable audio capture. By default, audio capture is set to **From HDMI**.

If you select analog audio, you also need to select the **Sampling rate** used to receive audio. By default, the audio sampling rate is 48.0 kHz.

11.1.4 Encoding

These settings determine how your encoder compresses and transmits the video and audio signals.

11.1.4.1 Use specific video size

Enable this to have PowerStream Plus reduce the size of the captured video before the video is encoded.

Specify the width and height, in pixels, of the video up to the width and height of the original video input. If your video source uses a different size, your encoder scales the video to the specified size (image may be distorted).

The width ranges from 128 to 1920 and must be a multiple of 16. The height ranges from 96 to 1200 and must be an even number.

11.1.4.2 Target bit rate

The bit rate in Mb/s (Megabits per second) at which your encoder should transmit the streaming signal. The actual bandwidth used by your encoder varies according to your source and encoding method.

The default is 15 Mb/s. The maximum bit rate is 25 Mb/s. A lower target bit rate may result in lower image quality. A higher target bit rate limit may result in lower performance.



11.1.4.3 Strategy

To determine the proper compression method, select if you want to favor speed or quality.

Favor speed	Minimizes the bandwidth required. This is the default setting.
Favor quality	Maximizes the quality of the image transmitted.

11.1.4.4 Group of pictures (GOP)

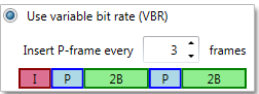
GOP length	The number of frames from one complete frame (I-frame) to another. A higher GOP length increases the compression level but may result in a lower quality image. The default is 90.
Use constant bit rate (CBR)	Enable this to limit the bit rate used to the target bit rate. Using a constant bit rate may result in dropped frames if the complexity of the source is high. When using constant bit rate, your actual bit rate may be lower than the target bit rate. Enable Allow filling bits to sustain bit rate to maintain the target bit rate even if the simplicity of the source image would reduce the bit rate.

<p>Use variable bit rate (VBR)</p>	<p>Enable this to use a variable bit rate. When using a variable bit rate, the actual bit rate may be significantly different from the target bit rate. Using a variable bit rate may result in a high bit rate if the complexity of the source is high.</p> <p>In Insert P-frame every X frames, enter the number of frames before a P-frame is inserted. All other frames are B-frames. A higher number of frames before inserting a P-frame increases the quality of the image but may result in a loss of performance. The minimum and default value is 1. The maximum value is 6. When selecting the number of P-frames, a preview of the GOP format is shown.</p> 
<p>Quantization parameters (For advanced users)</p>	<p>The range used to compress the various frames in your GOP. A high maximum increases the level of compression of the frame and should decrease the bit rate but may decrease the image quality. We recommend increasing the maximum values from I-frames to B-frames. The default values are between 10 and 36 for I-frames, 10 and 40 for P-frames, and 10 and 44 for B-frames.</p> 

11.1.4.5 Audio bit rate

Select the audio bit rate, in kbps, for your audio transmission (96, 128, 192, or 256 kbps). A higher bit rate produces a sound quality closer to the source quality, but requires more bandwidth. The default is 192 kbps.

11.1.5 Streaming/Recording

These settings determine if the stream is transmitted on the network or saved to a file.

11.1.5.1 Stream to network

Enable this option to transmit the stream of your encoder on the network.

11.1.5.1.1 Stream address (Unicast and Multicast)

The URL of the stream for this encoder. This stream address is used for unicast and multicast connections.

<p>Port</p>	<p>The port number used to transmit your stream. The default is 8554. For more information, see your network administrator.</p>
<p>Folder</p>	<p>Enter a subfolder as part of your stream address. If you're using a media player to decode your stream, the media player may require this to connect to a stream.</p>

11.1.5.1.2 Multicast



Note: When applying settings to multiple devices, make sure static IP addresses and multicast addresses aren't being duplicated. For more information, contact your network administrator.

Multicast address	<p>The IP address used to transmit the multicast stream. The IP address and corresponding port are transmitted by the encoder to a decoder requesting a multicast stream and any network switches or routers between the encoder and any connected decoder.</p> <p>To ensure that each decoder receives a single stream, each encoder should have a unique multicast address. IP addresses may range from 224.0.0.0 to 239.255.255.255. We recommend using an IP address between 224.2.0.1 and 224.2.255.255. The default is 224.2.0.1.</p>
Time to live (TTL)	<p>The number of network nodes (such as network switches or routers) through which a multicast signal can travel. Once the TTL number is reached, the receiving network node prevents the signal broadcast further down the network. The value ranges from 1 to 255. The default is 16.</p>



Note: Multicast may require additional network configuration to support the transmission protocol (some network switches and routers can block multicast signals). For more information, see your network administrator.

11.1.5.2 Record to network storage

Use this to record your capture to video files on a network drive. The video files created are encoded with an H.264 video and AAC audio codec in MP4 container format.



Note: When starting a recording manually or through a scheduled recording, it may take a few seconds before your encoder actually starts recording the video. When scheduling a recording, we recommend you start the recording earlier than the actual time required.



Note: If your network is slow, congested, or experiencing high traffic, your recording may fail. For more information, contact your network administrator.

11.1.5.2.1 Network shared folder

Provide the path to the existing network shared folder where your video files will be stored.



Note: To make sure the network path is properly recognized by your device, we recommend you provide the full computer name or the IP address of the system where the shared folder is located. The full computer name is part of the Windows properties of the system. For example, the full computer name of 'networkserver' may be *networkserver.domain.com*. For more information, see your network administrator.

If your network drive requires user identification, click **Change credentials** to provide a user name and password. You can also use this to remove user names and passwords that are no longer required.

11.1.5.2.2 File name prefix

The video file name is made up of two parts:

- **First part** – The name of the file, which you enter.
- **Second part** – The timestamp of when the video file started, which your encoder defines.

The resulting file name is *Prefix[YYYY-MM-DD_HH-MM-SS].mp4*, where YYYY is the year, MM the month, DD the day, HH the hour (in a 24-hour format), MM the minutes, and SS the seconds.

11.1.5.2.3 File duration

Enter the recording time for each video file recorded. Once the recording time for a file is reached, the encoder creates a new file.

If the sampling rate (audio or video) changes, a new file is created, regardless of the file duration.

11.1.5.2.4 Schedule recording

Enable this to schedule a date, time, and duration for your video recording.

Start recording	Enter the date and time to start recording.
Total duration	Enter the length of time to record video files.

When the recording starts, the encoder is listed as **Recording** for the total duration of the recording. When the recording ends, the encoder changes back to **Ready**.

11.2 Local output (for encoder)

This tab contains the local output settings of your encoder.

Local output

Use pass through

Use confidence preview

Video

HDMI + VGA

Size and transformations

Force display mode

1920 x 1080, 60 Hz

Scaling

Center in display

Image appearance

Brightness 750

Contrast 10000

Hue 0

Saturation 10000

Audio

HDMI channel

Mute 50

Analog channel

Mute 50

11.2.1 Selecting an output method

11.2.1.1 Use pass through

Output the video and audio signals of your source directly to your monitor and audio output device. You can use this option to see how your source video looks at the preferred display mode for your monitor and without transformations by the encoder.

While this is enabled:

- The source uses the EDID of the DVI or HDMI digital monitor connected to the **HDMI OUT** connector of your encoder to determine which display mode to use. If no EDID is detected, the source may disable its video output and capture is impossible.
- The encoder must support the display mode used by the source for capture, encoding, streaming, or recording to work.
- The output settings (such as **Size and transformations** and **Image appearance**) for your encoder have no effect and are disabled.
- If capture isn't working on your encoder, the source video still plays on your monitor.
- No analog video signal is received, so there's no video output on the VGA connector (analog video output).
- If the HDMI output device connected to your encoder doesn't support audio output, your HDMI source may disable its audio output. Because no audio is received at input, there's no audio for the encoder and all decoders connected to this encoder.

11.2.1.2 Use confidence preview (default)

Output the video signal as it's captured and transformed using the **Capture** and **Local output** (video and audio) settings of the encoder to your monitor and audio output device. Use confidence preview if no monitor is connected to your encoder. You can use this option to see the transformations configured through the output settings of your encoder.

While this is enabled:

- No monitor needs to be connected to your encoder. The source uses the EDID of the encoder to determine which display mode to use. The preferred display mode of the encoder is 1920 × 1080 @ 60 Hz.
- The output settings (such as **Size and transformation** and **Image appearance**) are used to output the video to the monitors.
- The transformations are done directly to the display mode received from the source, which may be different from the display mode of the encoded stream. For more information, see “11.1.4 - Encoding”, page 147.
- Your encoder can output to a DVI or HDMI digital monitor connected to the **HDMI Out** connector, to an analog monitor connected to the **VGA** connector, or to both.
- Your encoder outputs the same display mode to both the **HDMI Out** and **VGA** connector.
- For its output display mode, you can force a display mode, or you can let the encoder use the EDID of the monitor detected to determine which display mode to use. For more information, see “11.2.2.2.1 - Force display mode”, page 153.

11.2.2 Video

11.2.2.1 Video output type

Select the video type for your output (**HDMI + VGA**, **HDMI**, **VGA**, or **No outputs**). By default, video output is set to **HDMI + VGA**.

Selecting **No outputs** or **VGA** disables HDMI audio.

11.2.2.2 Size and transformations

This defines how the local output displays video.

11.2.2.2.1 Force display mode

When this option is enabled, the encoder uses the selected display mode for your monitor. The display mode is the combination of display resolution and refresh rate. Depending on your monitor and the display mode selected, black borders may appear above and below, on each side of, or around your video.







When this option is disabled:

- If a DVI or HDMI monitor is connected to the **HDMI Out** connector of your encoder, the encoder uses the EDID of that monitor to output. Each monitor has a preferred display mode defined in its EDID. If your device supports that display mode, both the encoder and the monitor use that mode. If the encoder doesn't support that display mode, the encoder selects a display mode that both devices support. For more information, see your monitor documentation or contact your monitor manufacturer.
- If no monitor is connected to the **HDMI Out** connector, or if **Video output type** is set to **VGA**, the encoder uses its preferred display mode of 1920 × 1080 @ 60 Hz. If your analog monitor doesn't support 1920 × 1080 @ 60 Hz, we recommend you enable **Force a display mode** and select a display mode your analog monitor supports.

This option is disabled by default.

11.2.2.2.2 Scaling



Select how the video appears in your display area.

<p>Center in display</p>	<p>The video appears in the center of the display area. If the video resolution is smaller than the output resolution, the video isn't scaled. If the video resolution is larger than the output resolution, the video is scaled as if it was set to Fit in display. Black borders may appear around your video. By default, scaling is set to Center in display.</p> <div style="display: flex; align-items: center;">   </div>
<p>Stretch to display</p>	<p>The video is scaled to fit the entire display area. If the display area has a different aspect ratio than the display area, the image may be distorted.</p> <div style="display: flex; align-items: center;">   </div>
<p>Fit in display</p>	<p>The video is scaled to fit the display area without distorting the image. If the display area has a different aspect ratio than the display area, black borders appear either above and below or on each side of your video.</p> <div style="display: flex; align-items: center;">   </div>

11.2.2.3 Image appearance

This enables you to adjust the color settings of your video output.

<p>Brightness</p>	<p>Increase or decrease how light or dark the colors appear. The default is 750.</p> <div style="display: flex; align-items: center;">  </div>
--------------------------	--

Contrast	Change the difference in brightness between the lightest and darkest colors. The default is 10000. 
Hue	Increase or decrease the tint or tone of colors. The default is 0. 
Saturation	Increase or decrease the depth of the colors. The default is 10000. 

11.2.3 Audio

The volume for the **HDMI channel** and **Analog channel** of your device. The default is 50.

Click **Mute** to disable audio output.

11.3 Network

This contains the network settings for the connection and IP address of your device.

Network

Connection settings

IP address

Dynamic IP address (DHCP)

Static IP address

IPv4 address

IPv4 netmask

IPv4 gateway

For this change to take effect, the device will be rebooted.

11.3.1 Connection settings

Select the link speed and duplex mode used by your device. The connection settings you select depend on your network configuration. For more information, see your network administrator.

Up to 1 Gbps / Full duplex	Device establishes the maximum link speed and the duplex mode to use on your network. This is the default setting.
100 Mbps / Full duplex	Device uses a link speed of 100 Mbps (Megabits per second) and a full-duplex mode. Some network configurations only support this setting.
100 Mbps / Half duplex	Device uses a link speed of 100 Mbps (Megabits per second) and a half-duplex mode. Some network configurations support only this setting.

11.3.2 IP address



Note: When the IP address or the method of assigning an IP address to a device changes, you need to reboot the device for the changes to take effect.

Select how to assign an IP address to your device.

By default, **Use a dynamic IP address (DHCP)** is used. For information on manually assigning a **Static IP address**, see “3.1 - Network discovery”, page 20.

11.4 RS232

Enable this to virtualize an RS232 (or serial) connection.

RS232 virtualization

Disabled

Decoder
Select a decoder...

TCP port
11999

RS232 settings

Baud rate
115200

Data bits
8

Parity
None

Stop bits
1

Flow control
None

11.4.1 Enabling RS232 virtualization

To enable RS232 virtualization, select the type of RS232 connection to use.

Disabled	Disable RS232 to close the TCP port used for virtualization.
Relayed serial over IP	In a relayed connection, the RS232 controller must be connected to your encoder to send commands to an RS232 device that's connected to a decoder. The RS232 connection is independent of any other connection between an encoder and a decoder. When using this option, the RS232 settings of your encoder are sent to the decoder. To establish a relayed connection, the encoder and the decoder must both use Relayed serial over IP .
Direct serial over IP	In a direct connection, an RS232 controller can send commands directly to the RS232 device connected to your encoder. The RS232 controller isn't physically connected to a device. Any encoder that uses direct serial over IP receives the RS232 commands through an opened TCP port (for example, from a telnet session) and sends these commands to the RS232 device connected to it.

11.4.2 Configuring RS232

Select decoder	If Relayed serial over IP is selected, select the decoder that's connected to the RS232 device you want to communicate with. The RS232 connection is virtualized only between your encoder and this decoder. This setting isn't available if Direct serial over IP is selected.
TCP port	If Direct serial over IP is selected, select which port will receive the RS232 commands. (Make sure the port number is available and not used by another service on your network.) The default is 11999. This setting isn't available if Relayed serial over IP is selected.
RS232 settings	If Relayed serial over IP is selected, the following settings are used by the encoder and the selected decoder. If Direct serial over IP is selected, the following settings are used only for the device connected to your encoder. <ul style="list-style-type: none">▪ Baud rate – The speed, in bits per seconds (or baud), used for the RS232 connection. The default is 115200.▪ Data bits – The number of bits per block of data transmitted. The default is 8.▪ Parity – The type of parity bits (None, Odd, or Even) used for the data transmitted. The default is None.▪ Stop bits – The number of bits used to identify the end of a data block. The default is 1.▪ Flow control – The signal type (None or RTS/CTS) used to pause and resume data transmission. The default is None.

11.5 Date and time

Use this to update the date, time, and time zone of your Maevox device. For more information on these settings, see “14 - Adjusting the date and time of your device”, page 169.

12 Maevox 5150 decoder settings

This enables you to view, configure, and manage settings specific to a Maevox 5150 decoder.

12.1 Decoding

These settings define how the streaming signal is processed by your decoder.

The screenshot shows the 'Decoding' settings panel. On the left, there is an 'Enable' toggle switch set to '1'. Below it is a 'Source' dropdown menu set to 'Manual'. The 'Stream address' field contains the text 'rtsp://192.168.154.50:3049/S22'. Underneath, the 'Stream display mode' is set to 'Not available'. At the bottom left, there is a 'Crop video' checkbox which is unchecked, followed by four input fields for 'Left', 'Top', 'Width', and 'Height', all set to '0'. On the right side, the 'Routing scheme' is set to 'UDP unicast'. Below that, there are two sliders: 'Network latency' and 'Maximum decoding lateness', both set to '160 ms'. At the bottom right, the 'Extra delay' is set to '0 ms'.

12.1.1 Modify settings

To modify the settings for multiple devices at the same time:





- 1 From the PowerStream Plus main interface, press the [Ctrl] key, select the tiles of the devices you want to modify, then click **Multi-device settings**. The device tiles you select must be of the same type.
- 2 Enable the **Modify settings** option.
- 3 Select your preferred device, then make your changes.
- 4 When you're done, click **Apply**. This applies the settings from the preferred device to the other selected devices.

12.1.2 Enable decoding

Click this to start or stop decoding the streaming signal. This button is disabled until a **Stream address** is entered. If the **Stream address** is invalid, or if the stream isn't transmitted, clicking **Enable** results in an error.

When you start decoding, it may take a few seconds before the video appears on your monitor.

12.1.3 Source

Select an encoder to use as a source. The icon next to the encoder name represents its current status. You can only select encoders listed as **Ready** (), **Awaiting connection** (), **Recording** (), or **Encoding** ().

When a stream is selected, PowerStream Plus uses the current URL as the stream address. When the source is set to **Manual**, PowerStream Plus uses the URL in **Stream address** to connect to a stream. If a stream isn't compatible with your device, an () icon appears.

To connect to a stream outside the subnet and not listed as a source, you need to manually enter the stream address for the encoder stream.

12.1.3.1 Maevox 6152 encoder streams for Maevox 5150 decoder

The following is a list of Maevox 6152 encoder configurations that is required for compatibility with a Maevox 5150 decoder.

- Protocol - RTSP only
- Audio encoding - AAC-LC only
- Maximum resolution - 1920 x 1080p60
- Maximum bit rate - 25 Mbps
- Color space - YUV 4:2:0, 8-bit only



Note: For the Maevox 6152 encoded stream to be compatible with the Maevox 5150 decoder, the **Estimated H.264 Level** should be **4.2** or below.

12.1.4 Stream address

This is the URL of the stream to be decoded. When you select a **Source**, PowerStream Plus automatically adds the stream address.

This control is disabled when the decoder is decoding.

12.1.5 Stream display mode

This is the display mode of the stream received by the decoder. A display mode is a combination of display resolution and vertical refresh rate.

12.1.6 Crop video

Enable this to define which area of the video is visible after decoding. To define the video area, adjust the following:

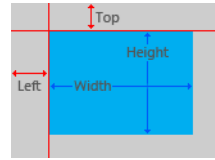

Left	The number of pixels removed from the left side of the original video area. The value must be an even number. The default is 0.
Top	The number of pixels removed from the top of the original video area. The default is 0.
Width	The width, in pixels, of the resulting video area. The value must be an even number. The default is 64.
Height	The height, in pixels, of the resulting video area. The default is 64.

12.1.7 Routing scheme

Select the type of signal received by your decoder:



Note: When applying settings to multiple devices, make sure static IP addresses and multicast addresses aren't being duplicated. For more information, contact your network administrator.

UDP unicast	A stream is created for each decoder connected to an encoder. No additional network configuration is required, because unicast establishes a direct connection between an encoder and a decoder. Since each decoder connected to an encoder increases the bandwidth used by that encoder, unicast may use more bandwidth. This is the default.
UDP multicast	A single stream is created by the encoder and all decoders connected to the same multicast group as the encoder receive that stream. When transmitting to multiple decoders, an encoder that's properly configured for multicast transmission uses less bandwidth.



Note: The stream address for the encoder is the same, regardless of the routing scheme.

12.1.8 Network latency

Network latency is the number of milliseconds (ms) before your decoder discards an improperly received frame and moves on to the next frame. With slow networks or high-traffic networks, a high network latency is recommended to reduce the possibility of dropping frames.

Latency and lateness are the delay between the time a frame is received and the time it's ready to be shown.

The default is 160 ms.

12.1.9 Maximum decoding lateness

Maximum decoding lateness is the number of milliseconds (ms) your decoder has to decode a frame before it discards that frame. Lateness varies depending on how difficult a frame is to decode. When setting this value, consider that a stream with only audio is easier to decode than one with only video, and a stream with only video is easier to decode than one with both video and audio.

Latency and lateness are the delay between the time a frame is received and the time it's ready to be shown.

The default is 160 ms.

12.1.10 Extra delay

Extra delay is the number of milliseconds (ms) between the moment a frame is ready to be shown and the moment it's actually shown on screen. For example, extra delay enables you to configure multiple decoders connected to the same encoder to display a video at the same time regardless of their location.

The maximum value is 60000 ms. The default is 0 ms.

12.2 Local output (for decoder)

Decoders use the local output settings to output to a monitor.

Your decoder follows these guidelines:

- It uses the display mode of the video stream received by an encoder as its input.
- The display resolution of the video stream can be reduced by using the **Crop video** option in PowerStream Plus.
- The **Output settings** (such as **Size and transformation** and **Image appearance**) are used to send the video signal to the monitor connected to the decoder.

- It can force a display mode, or it can use the EDID of the monitor detected to determine which display mode to use.

12.2.1 Video

12.2.1.1 Video output type

Select the video type for your output (**HDMI** or **No outputs**).

Selecting **No outputs** disables HDMI audio.

12.2.1.2 Size and transformations

This defines how the local output displays video.

12.2.1.2.1 Force display mode

Enable this option to have the decoder use the selected display mode to output the video signal. A display mode is the combination of display resolution and refresh rate.

If this option is disabled, your decoder uses the EDID of the digital monitor (DVI or HDMI) connected to its HDMI connector to determine which display mode to use to output the video signal. To determine the best display mode to use, each monitor has a preferred display mode defined in its EDID. If your decoder supports that display mode, both the decoder and the monitor use that mode. If the decoder doesn't support that display mode, the decoder selects a display mode that both the decoder and the monitor support. For more information, see your monitor documentation or contact your monitor manufacturer.

Depending on your monitor and the display mode used, black borders may appear (on the top and bottom of, on the right and left of, or around your video).



This option is disabled by default.

12.2.1.2.2 Scaling

Select how the video appears in your display area.

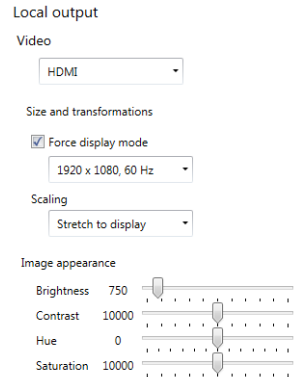



<p>Center in display</p>	<p>The video appears in the center of the display area. If the video resolution is smaller than the output resolution, the video isn't scaled. If the video resolution is larger than the output resolution, the video is scaled as if it was set to Fit in display. Black borders may appear around your video. By default, scaling is set to Center in display.</p> <div style="display: flex; align-items: center; justify-content: center;">  </div>
---------------------------------	--



Stretch to display	The video is scaled to fit the entire display area. If the video stream has a different aspect ratio than the display area, the image may be distorted.	
Fit in display	The video is scaled to fit the display area without distorting the image. If the video stream has a different aspect ratio than the display area, black borders appear either above and below or on each side of your video.	

12.2.1.3 Image appearance

This enables you to adjust the color settings of your video output.

Brightness	Increase or decrease how light or dark the colors appear. The default is 750.	
Contrast	Change the difference in brightness between the lightest and darkest colors. The default is 10000.	
Hue	Increase or decrease the tint or tone of colors. The default is 0.	
Saturation	Increase or decrease the depth of the colors. The default is 10000.	

12.2.2 Audio

The volume for the **HDMI channel** and **Analog channel** of your device. The default is 50.

Click **Mute** to disable an audio output.

12.3 Network

This contains the network settings for the connection and IP address of your device.

Network

Connection settings

IP address
 Dynamic IP address (DHCP)
 Static IP address

IPv4 address
 IPv4 netmask
 IPv4 gateway

For this change to take effect, the device will be rebooted.

12.3.1 Connection settings

Select the link speed and duplex mode used by your device. The connection settings selected depend on your network configuration. For more information, see your network administrator.

Up to 1 Gbps / Full duplex	Device establishes the maximum link speed and the duplex mode to use on your network. This is the default setting.
100 Mbps / Full duplex	Device uses a link speed of 100 Mbps (Megabits per second) and a full-duplex mode. Some network configurations only support this setting.
100 Mbps / Half duplex	Device uses a link speed of 100 Mbps (Megabits per second) and a half-duplex mode. Some network configurations support only this setting.

12.3.2 IP address



Note: When the IP address or the method of assigning an IP address to a device changes, you need to reboot the device for the changes to take effect.

Select how to assign an IP address to your device.

By default, **Use a dynamic IP address (DHCP)** is used. For information on manually assigning a **Static IP address**, see “3.1 - Network discovery”, page 20.

12.4 RS232

Enable this to virtualize an RS232 (or serial) connection.

RS232 virtualization

Disabled ▾

Decoder

Select a decoder... ▾

TCP port 11999 ▾

RS232 settings

Baud rate 115200 ▾

Data bits 8 ▾

Parity None ▾

Stop bits 1 ▾

Flow control None ▾

12.4.1 Enabling RS232 virtualization

To enable RS232 virtualization, select the type of RS232 connection to use.

Disabled	Disable RS232 to close the TCP port used for virtualization.
-----------------	--

Relayed serial over IP	<p>A relayed connection requires the RS232 controller to be connected to your Maevox 5150 encoder to send commands to an RS232 device connected to a decoder. The RS232 connection is independent of any other connection between an encoder and a decoder. When using relayed serial over IP, the RS232 settings of your encoder are sent to the decoder. To establish a relayed connection, the encoder and the decoder must both use relayed serial over IP.</p> <p>While using Relayed serial over IP, the TCP port setting isn't available.</p>
Direct serial over IP	<p>A direct connection allows an RS232 controller to send commands directly to the RS232 device connected to your decoder. The RS232 controller isn't physically connected to a decoder. A decoder that uses direct serial over IP receives the RS232 commands through an opened TCP port (for example, from a telnet session) and sends these commands to the RS232 device connected to it.</p> <p>While using Direct serial over IP, select the TCP port that will receive the RS232 commands. When selecting a port, make sure the port number is available and not used by another service on your network.</p>

12.4.2 Configuring RS232

For more information on the RS232 settings to use, see the documentation for your RS232 devices.

TCP port	<p>While using Direct serial over IP, select which port will receive the RS232 commands. When selecting a port, make sure the port number is available and not used by another service on your network. The default is 11999.</p> <p>While using Relayed serial over IP, this setting isn't available.</p>
RS232 settings	<p>While using Relayed serial over IP, these settings are used by the Maevox 5150 encoder and the selected decoder. While using Direct serial over IP, these settings are used only for the device connected to your encoder.</p> <ul style="list-style-type: none"> ▪ Baud rate – The speed in bits per seconds (or baud) used for the RS232 connection. The default is 115200. ▪ Data bits – The number of bits per block of data transmitted. The default is 8. ▪ Parity – The type of parity bits (None, Odd, or Even) used for the data transmitted. The default is None. ▪ Stop bits – The number of bits used to identify the end of a data block. The default is 1. ▪ Flow control – The signal type (None or RTS/CTS) used to pause and resume data transmission. The default is None.

12.5 Date and time

Use this to update the date, time, and time zone of your Maevox device. For more information on these settings, see “14 - Adjusting the date and time of your device”, page 169.

12.6 Failsafe

This feature enables you to show an image or a video file stored on your decoder when the decoder isn't receiving a stream.

Local failsafe file	The name of your failsafe file.
Disable failsafe	This disables failsafe on your decoder. To delete an image or a video file currently on your decoder, enable Remove failsafe file from decoder . If your decoder doesn't have a failsafe file, this option is disabled.
Enable failsafe	This enables failsafe on your decoder. <ul style="list-style-type: none">▪ Activate failsafe – Adjust the amount of time, in seconds (up to 300), it will take to display the failsafe file on your decoder <i>after</i> the decoder stops receiving a stream.▪ Upload the failsafe file – Browse to the video (mp4) or image (jpg) file you want to upload to your decoder. This failsafe file is stored on your decoder and appears when the decoder isn't receiving a stream. For more information, see “12.6.1 - Failsafe requirements”, page 166.

12.6.1 Failsafe requirements

The video or image files supported require the following:

- The width ranges from 128 to 1920 and must be a multiple of 16.
- The height ranges from 96 to 1200 and must be an even number.
- A video file must be encoded with the H.264 video codec and the AAC audio codec in MP4 container format.
- A video file can only use mono or stereo audio format.
- The maximum size for the failsafe file is 3.4 GB.

13 Managing your configurations

Maevox 6100 Series Encoders and Maevox 6152 Decoder only – To save, export, and edit the configurations of your Maevox 6100 Series Encoders and Maevox 6152 Decoder devices, select a device, then click **Manage Configurations**.



Note: This option is available only with all the Maevox 6100 Series Encoders and the Maevox 6152 Decoder products.

13.0.1 Saving a configuration

To save a configuration:

- 1 Click **Manage Configurations**, then click **Save**.
- 2 Enter a **Name** and **Description** for your configuration, then click **Save**.



Note: For naming the file, use alphabets and numbers avoiding special characters as some special characters are not supported.

13.0.2 Selecting a configuration

To select a configuration:

- 1 Click **Manage Configurations**, then click **Select**.
- 2 From the list select the **Default** configuration or a **User Defined** configuration.
- 3 Choose how to affect the settings (**Processing**, **Decoding**, **Network**, and **Date and time**).
- 4 When you're done, click **Select**.

13.0.3 Editing a saved configuration

13.0.3.1 Renaming

To rename a configuration:

- 1 Click **Manage Configurations**, then click **Edit**.
- 2 From the list, select a configuration, then click **Rename**.
- 3 Enter a new **Name** or **Description**, then click **Save** → **Close**.

13.0.3.2 Deleting

To delete a configuration:

- 1 Click **Manage Configurations**, then click **Edit**.
- 2 From the list, select a configuration, then click **Delete**.

13.0.3.3 Opening file location

To open the configuration file (.fav) in Explorer:

- 1 Click **Manage Configurations**, then click **Edit**.
- 2 From the list, select a configuration, then click **Open file location**.

13.0.4 Importing and exporting configurations

13.0.4.1 Importing

To import a configuration:

- 1 Click **Manage Configurations**, then click **Import** → **Select folder**.
- 2 When prompted, browse to the folder where your .fav file was saved, select that folder, then click **Select Folder**.
- 3 From the list, select the configuration, then click **Import**.

13.0.4.2 Exporting

To export a configuration:

- 1 Click **Manage Configurations**, then click **Export** → **Folder**.
- 2 When prompted, browse to the folder where you want to save your .fav file, then click **Select Folder**.
- 3 From the list, select the configuration, then click **Export**.

14 Adjusting the date and time of your device

Use this to update the date, time, and time zone of your Maevox device.

The screenshot shows a configuration page with the following sections:

- NTP server:** Enabled
- NTP server URL:** time.nrc.ca
- Time zone:** (GMT-5:00) Eastern Time (US and Canada)
- Date and time**
 - Use current date and time settings of the device
 - Use date and time of the current system
 - Use the following date and time
 - Input field: Friday, June 22, 2018 10:50:32
 - Enable synchronization with an NTP (Network Time Protocol) server
 - NTP server URL input field: time.nrc.ca
 - Disable synchronization with an NTP server
- Time zone**
 - Use current time zone of the device
 - Use the following time zone

The current time settings are listed in the grey box. PowerStream Plus updates this information every two (2) seconds.



Note: After applying new settings, it may take some time for the changes to take effect.

14.1 Setting the date and time

Select how to set the date and time for your device.

Use current date and time settings of the device	Keep the current date, time, and NTP (Network Time Protocol) synchronization settings for your devices. This is the default.
Use date and time of the current system	Use the date and time of your controller system to update your devices. This setting uses the time zone of the controller system. If your controller system and your device are using different time zones, the date and time will differ. This setting disables synchronization with an NTP server.
Use the following date and time	Use the date and time specified to update your devices. This setting doesn't use the time zone of your controller system. You can use the arrow keys to change the date and time specified. This setting disables synchronization with an NTP server.

Enable synchronization with an NTP server	Use an NTP server to update the date and time for your device at regular intervals. When used in IPv6 only mode, the time server has to use an IPv6 address. You must provide the NTP server URL , even if one is already stored on your device. For more information on using NTP, contact your network administrator.
Disable synchronization with an NTP server	Stop using an NTP server to update the date and time for your device. Disabling NTP keeps the current date and time of the device, but it won't update the devices at regular intervals.

14.2 Setting the time zone

Select the time zone to use for your device. When using an NTP server, we recommend setting the time zone of your device.

Use current time zone of the device	Use the time zone currently set for your devices. This is the default.
Use the following time zone	Change the time zone for your devices to the one selected. Changing the time zone may adjust the date and time for a device.

15 Troubleshooting

15.1 What to do if you have a problem

If you experience problems with your Matrox product:

- Make sure you're using the correct connectors, and that all connectors are properly fastened. For more information on the connection setup of your product, see the user guide for your Matrox hardware.
- Review the documentation provided with your Matrox product, including the information in this section, to see if your problem is already addressed. For information on Matrox PowerStream Plus software features and options, see the help file included with your PowerStream Plus software.

If your problem persists, contact Matrox. For more information, see [“18 - Customer support”](#), page 194.

15.2 Common problems and solutions

This section addresses common problems that could prevent you from using your devices.

Problem MaeveX device not discovered on the network

Cause You may not be using the latest version of Matrox PowerStream Plus software, or your Matrox firmware may be out of date.

Solution For your MaeveX devices to be properly detected, make sure all Matrox software is up to date.

Cause Your Matrox product may not be properly connected or may be on a different subnet.

Solution Verify the connection and status LEDs on your Matrox product. Also, make sure your Matrox product is properly connected and that all connectors are properly fastened. For more information, see your Matrox MaeveX Series User Guide.

Cause **Windows Server 2022 and 2019 only** – The Windows SSDP Discovery service may be disabled on your system.

Solution Make sure the SSDP Discovery service is enabled on your system.

1 **Windows Server 2022/2019** – Click **Start** → **Administrative tools** → **Services***. (* You may need administrator rights to access Windows services.)

2 Double-click **SSDP Discovery**.

3 Next to **Startup type**, select **Manual** or **Automatic**.

4 Click **OK**.

Cause Network discovery and file sharing may not be enabled on your system.

Solution Enable network discovery and file sharing on your system.

Windows 10

1 Windows 10 – Click **Start** → **Settings** → **Network & Internet** → **Ethernet**.

2 Click **Network and Sharing Center** → **Change advanced sharing settings**. (* Depending on your version and configuration of Windows, this part of the step may not be necessary.)

3 Under your current profile, make sure the following options are selected:

- **Turn on network discovery**
- **Turn on file and printer sharing**

4 If you make changes to your current profile settings, click **Save changes**.

Windows 11

1 Type **control panel** from the search box and click on **Control Panel** to open it.

2 Select **Network & Internet** → then select **Network and Sharing Center**.

3 Select **Change advanced sharing settings**.

4 Turn on file sharing by doing the following:

- Under **Private** (current profile), select **Turn on network discovery**. Also check **Turn on automatic setup of network connected devices**.
- Expand **Private** (current profile) and check **Turn on file and printer sharing** under **File and printer sharing**.
- Scroll down and expand **All networks**. Check **Turn on sharing so that everyone with network access can read and write files in the Public folders** under **Public folder sharing**.

5 Save your changes.

Cause The firewall for your controller system or for your network may be enabled and may prevent communication with your Maevex devices.

Solution Make sure your firewall is properly configured to allow the necessary communication between your controller system and your Maevex devices. For more information, see “[17 - Appendix – Firewall requirements](#)”, page 190.

Problem Can't access Maevox device through PowerStream Plus
(listed as 'View only')

Cause The device may be a recent addition to your environment and has no password.

Solution Try changing the password for that device (see "4 - Managing users and passwords", page 23).

Cause **Maevox 5150 encoder or 5150 decoder** – The device password doesn't match your environment password.

Solution Try a configuration reset of your Maevox device. For more information, see your Matrox Maevox Series User Guide.

Solution Contact your Maevox environment administrator to obtain your device password, then change the device password to match your environment password in PowerStream Plus. For more information, see "4 - Managing users and passwords", page 23.

Problem No picture or output at all

Cause The device may not have started encoding or decoding.

Solution In PowerStream Plus, make sure the encoding or decoding process has started:

- **Maevox 6152/6122/6100 encoder** – Listed as **Active**. The stream you're trying to connect to needs to be enabled.
- **Maevox 5150 encoder** – Listed as **Awaiting connection** or **Encoding**.
- **Maevox 5150 decoder** – Listed as **Decoding**. If the decoder isn't decoding, verify that the correct URL is being used in the **Stream address** box. If the URL in **Stream address** doesn't match the URL of an encoder, or if the encoder isn't encoding, attempting to start decoding results in an error.

For more information, see "2.8 - Understanding the status of your devices", page 18.

Cause **Maevox 7112 encoder** – The HDMI source is sending HDCP-protected content, resulting in black or blue video stream (no video).

Solution Maevox 7112 encoders do not support streaming of HDCP-protected content. Use non-protected content from your source and/or disable HDCP content protection on your source device.

Cause **Maevox 5150 encoder** – The **Use pass through** option is enabled, but your monitor is connected to the **VGA** connector on your encoder.

Solution If the **Use pass through** option is enabled, make sure your monitor is connected to the **HDMI Out** connector.

Solution In PowerStream Plus, change the local output of your encoder to **Use confidence preview**.

Cause Maevox 5150 encoder – The local output settings of your device may be improperly set.

Solution If the **Use confidence preview** option is enabled, adjust the following settings under the **Output** tab in PowerStream Plus:

- Make sure the video output type selected is valid (**HDMI + VGA, HDMI, or VGA**).
- Disable the **Force display mode** option.
- Check your **Image appearance** settings (brightness, contrast, and so on). Image appearance values that are too high or too low may cause the image to disappear.

Solution **Decoder** – In PowerStream Plus, adjust your local output settings:

- Disable the **Force display mode** option.
- Check your **Image appearance** settings (brightness, contrast, and so on). Image appearance values that are too high or too low may cause the image to disappear.

Cause Your monitor video controls may be improperly set.

Solution Adjust your monitor controls (brightness, contrast, and so on). For more information, see your monitor manual.

Cause Your monitor may not be properly connected (the connectors aren't properly fastened or the monitor power cable isn't firmly in place) or may have been disconnected.

Solution Make sure you're using the correct connectors, that all connectors are properly fastened, and that all power cables are firmly in place.

Cause If your monitor supports multiple input sources (analog/digital), it may be configured to use the wrong source.

Solution Make sure your monitor is using the correct input source. For more information on selecting the input source for your monitor, see your monitor documentation.

Cause The HDMI cable may have been connected to your encoder or decoder output *after* the encoding or decoding process started.

Solution Stop, then start the encoding or decoding process again.

Problem Recording starts, then stops
(red dot blinks and then disappears)

Cause The path to the recording destination may be incorrect (for example, the network path is incorrect or unrecognized).

Solution Make sure the network path is correct and the full computer name is specified.

Problem Storage path error message when specifying a network shared folder for recording

Cause The path for the network shared folder may be incorrect.

Solution Make sure you're using the full computer name of the system where the shared folder is located. The full computer name is part of the Windows properties of the system. For example, the full computer name of *networkserver* may be *networkserver.domain.com*. For more information, contact your network administrator.

Cause The file sharing configuration for the system hosting the shared folder may prevent writing operations.

Solution Make sure file sharing is enabled on your host system and that writing is permitted on that folder.

Cause The credentials provided to your encoder may not have writing permissions on the system hosting the shared folder.

Solution Make sure you're using the proper user credentials (user name and password) for your encoder.

Solution Make sure the permissions of the shared folder allow writing.

Cause The firewall may be enabled on the system that hosts the shared folder.

Solution Add rules to your Windows Firewall settings. For more information, see [“17.5 - Adding rules to your Windows Firewall settings”](#), page 192.

Problem Wrong color balance

Cause The local output settings of your encoder or decoder may be improperly set.

Solution Adjust your PowerStream Plus settings. Check your **Image appearance** settings (brightness, contrast, and so on).

Cause Your monitor video controls may be improperly set.

Solution Adjust your monitor controls (brightness, contrast, and so on). For more information, see your monitor manual.

Cause Your monitor may not be properly connected (the connectors aren't properly fastened or the monitor power cable isn't firmly in place) or may have been disconnected.

Solution Make sure you're using the correct connectors, that all connectors are properly fastened, and that all power cables are firmly in place.

Problem **Screen image is cropped, appears off-center, or uses a portion of the screen**

Cause You may be using a lower display resolution than what your monitor supports. If your monitor supports display scaling, the image on your screen may appear blurry. If display scaling isn't supported, the display may use only a portion of your screen.

Solution In PowerStream Plus, adjust **Force display mode** to use the highest display resolution available. This generally results in better image quality.

Cause PowerStream Plus may be configured to modify the size of the video source.

Solution Adjust your PowerStream Plus settings:

- **Maevox 6152 decoder** - Make sure the settings for scaling and target display or sub-panel are set to properly show the video.
- **Maevox 6152/6122/6100 encoder** – Click the **Processing** tab, then make sure the width and height specified in the **Processing** or **Encoding** settings match the aspect ratio of your source.
- **Maevox 5150 encoder** – Click the **Processing** tab, enable the **Use specific video size** option, then specify the width and height of your video to match the aspect ratio of your source.
- **Maevox 5150 decoder** – Make sure the settings for **Crop video** are set to properly show the video.

Problem **Using 'pass through', the screen is unusable (Maevox 5150 encoder only)**
(blank or blinking screen)

Cause Your monitor may be incompatible with the display mode used by your source.

Solution Make sure your monitor and your source support similar display modes. To validate the quality of your source, see your Matrox Maevox Series User Guide.

Solution Change the display mode used by your source.

Solution Try using a different monitor.

Cause If your monitor and source aren't properly synching, your screen may go blank for a few seconds.

Solution In PowerStream Plus, change the local output of your encoder to **Use confidence preview**.

Solution Try using a different monitor.

Solution Make sure all Matrox software is up to date.

Problem Decoder loses connection to the encoder

Cause The encoder's settings may have changed (for example, the streaming address or IP address). A change may occur dynamically or after a power failure.

Solution Adjust your PowerStream Plus settings:

- **Maevox encoder** – Manually change the IP address to the previous address used by your encoder.
- **Maevox 5150 decoder** – Reselect the encoder in your **Source** box.
- **Maevox 5150 decoder** – If **Source** is set to **Manual**, make sure the URL used in the **Stream address** box matches the stream address used by the encoder.

For more information, see [“2.8 - Understanding the status of your devices”](#), page 18.

Cause The encoder may have stopped transmitting.

Solution Make sure your encoder is transmitting.

Problem PowerStream Plus may be slow to start (several minutes)

Cause Your controller system may not have access to a DNS (Domain Name System) server.

Solution Configure your system to use a fixed IP address (such as local host – 127.0.0.1) as the DNS server.

Windows 11/10

- 1** Windows 11/10 – Click **Start** → **Settings** → **Network & Internet** → **Ethernet**.
- 2** Click **Change adapter settings**.

- 3 Double-click the icon for your network adapter (such as **Local Area Connection** or **Ethernet**).
- 4 Click **Properties** → **Yes***. (* Depending on your version and configuration of Windows, this part of the step may not be necessary.)
- 5 Double-click **Internet Protocol Version 4 (TCP/IPv4)**.
- 6 Select **Use the following DNS server addresses**.
- 7 Next to **Preferred DNS server**, enter **127.0.0.1**.
- 8 Click **OK** → **OK** → **Close**.

Problem PowerStream Plus stops responding

Cause Your PowerStream Plus software or Maevox device may have encountered an error.

Solution Try closing, then restarting Matrox PowerStream Plus software.

Solution Restart your controller system.

Problem Maevox device tile is listed as unresponsive (yellow device tile)

Cause Your network may be slow, causing a delay in the response time from your Maevox device.

Solution Wait a few minutes, then make sure the status of the device was properly updated.

Cause Your PowerStream Plus software or device may have encountered an error.

Solution Try closing, then restarting Matrox PowerStream Plus software.

Solution If your device status is still listed as initializing, click **Reboot** to reboot your device.

Solution Try a configuration reset of your device. For more information, see your Matrox Maevox Series User Guide.

Problem 'Web services fails' message appears after attempting to change decoder settings

Cause The decoding process may take all the decoder's resources.

Solution Stop the decoding process, make your changes, and restart the decoding process.

Solution When making changes to multiple decoders connected to the same encoder, stop the encoder, make the changes on your decoders, then restart the encoder.

Problem Black border appears around the video

Cause The aspect ratio of your video source may not match the aspect ratio of your monitor.

Solution Use PowerStream Plus software to adjust your **Video** settings (such as enabling **Force display mode** and selecting a **Scaling** option).

Cause The border may be part of your video.

Solution Crop your video source:

- 1** Under your decoder settings, enable the **Crop video** option.
- 2** Enter values to remove the borders.
- 3** Click **Apply** for your changes to take effect.

Cause Your source uses a display resolution that's higher than the resolution used to show the video.

Solution Try configuring your source to use a different display resolution.

Cause Your monitor doesn't support display scaling.

Solution Adjust your video settings:

- 1** Under **Size and Transformation** of the **Local output** settings of your Maevox device, try selecting **Stretch to display** for scaling.
- 2** Click **Apply** for your changes to take effect.

Problem Video appears stretched or squished

Cause There may be a problem with your video source.

Solution Verify the quality of your source. For more information, see your Matrox Maevox Series User Guide.

Cause You may be encoding at a resolution that has a different aspect ratio than what your source or output is using.

Solution Try selecting a video size with the same aspect ratio as your source.

Solution

- Maevox 6152/6122/6100 encoder – Make sure **Force encoding size** is disabled.
- Maevox 5150 encoder – Make sure **Use specific video size** is disabled.

Cause The aspect ratio of your source may not match the aspect ratio of your monitor.

Solution Adjust your video settings:

- 1 Under **Size and Transformation** of the local output settings of your Maevox device, try selecting **Stretch to display** for scaling.
- 2 Click **Apply** for your changes to take effect.

Solution If possible, set the display resolution of your source to match the aspect ratio of your monitor.

Cause You may be using a lower display resolution than what your monitor supports.

Solution In PowerStream Plus, make sure **Force display mode** is disabled to use the highest display resolution supported by your monitor. This generally results in better image quality.

Cause PowerStream Plus may be configured to modify the size of the video source.

Solution Adjust your PowerStream Plus settings:

- **Maevox 6152/6122/6100 encoder** – Enable the **Force encoding size** option, then specify the width and height of your video to match the aspect ratio of your source.
- **Maevox 5150 encoder** – Enable the **Use specific video size** option, then specify the width and height of your video to match the aspect ratio of your source.
- **Maevox 5150 decoder** – Make sure the settings for **Crop video** are set to properly show the video.

Problem Image appears blurry

Cause You may be encoding at a different resolution than what your source is using.

Solution Try selecting a video size with the same aspect ratio as your source.

Solution If **Use specific video size** is enabled, try disabling it to avoid scaling by the encoder.

Cause You may be using a lower display resolution than what your monitor supports, or your monitor supports display scaling.

Solution In PowerStream Plus, adjust **Force display mode** to use the highest display resolution available. This generally results in better image quality.

Problem **Poor video quality or video is jerky**
(skipping or dropping frames)



Note: Jerky video may be the result of slow recording. Slow recording causes frames to be dropped (frames aren't recorded). If jerky video is caused by frames that were dropped during recording, the problem can only be fixed by recapturing the video under better conditions or with different video settings. For more information, see your Matrox MaeveX Series User Guide.

Cause PowerStream Plus may not be configured to optimize video or audio quality.

Solution When adjusting your encoder or decoder settings, we recommend starting with the default values for all of your settings and modifying the settings as necessary.

Cause High network traffic may be degrading the quality of your stream.

Solution Make sure your network equipment supports the bandwidth required.

Solution Try using a dedicated network for your MaeveX environment. For more information, contact your network administrator.

Solution Try using Matrox PowerStream Plus to increase the **Network latency** of your decoder.

Cause There may be too many video devices between your video source and destination, or one or more of the video devices may be degrading the quality of the stream. Adapters, long cables, cable extensions, and improper connections can all affect video signal quality.

Solution If possible, use fewer connections. For example, don't use cable extensions.

Problem **Unstable audio detection**
(audio signal undetected or unstable)

Cause Your audio driver may not be enabled to pass through HDMI.

Solution Test your playback devices:

- 1 In your Windows taskbar, right-click **Playback devices**.
- 2 Right-click each MaeveX device listed, then click **Test**.

Problem **No sound or sound is distorted or too loud**

Cause Your capture settings may not match your audio input.

Solution Make sure your capture settings are set to capture the proper audio source.

Cause Audio cables may be loose, or the audio output device may not be properly connected.

Solution Make sure you're using the correct connectors, all connectors are properly fastened, and that all power cables are firmly in place.

Cause There may be a problem with your audio source.

Solution Verify the quality of your source. For more information, see your Matrox Maevox Series User Guide.

Cause The PowerStream Plus **Audio** setting of your Maevox device may be too low, too high, or muted.

Solution Adjust your audio settings for the best performance.

Cause Maevox 6152/6122/6100 encoder – You may not be using an audio source, or your audio source may not be included in your encoding process.

Solution Adjust your audio settings:

- **Processing** – Make sure an **Audio source** is selected.
- **Encoding** – Make sure your signals is set to include audio (**Audio only** or **Audio and video**) in your encoding.

Cause Maevox 5150 encoder – If you're using pass through, your HDMI source may disable its audio output if the HDMI output device connected to your encoder doesn't support audio output. This disables the audio output for the encoder and all decoders connected to this encoder.

Solution Make sure the HDMI output device connected to your encoder supports audio output.

Solution In PowerStream Plus, change the local output of your encoder to **Use confidence preview**.

Cause Maevox 5150 encoder – If you're using pass through, your audio output device may be connected to a connector that has no corresponding input.

Solution Make sure your audio output device is connected to the proper corresponding audio input connector (for example, **HDMI** to **HDMI in**, and **Line out** to **Line in**).

Solution In PowerStream Plus, change the local output of your encoder to **Use confidence preview**.

Cause Maevox 5150 encoder – Your source may disable its HDMI audio output when switching from confidence preview to pass through, or vice versa.

Solution To re-enable the audio signal, try disconnecting and reconnecting your HDMI connector.

Problem Inconsistent sound quality between video files

Cause The audio level for the original video sources differs.

Solution Resample the original video sources to normalize the audio output between sources.

Solution Your source may be able to normalize audio levels automatically. For more information, see your source documentation.

Problem Unable to record to LAN2

Cause A unique IP address may not be specified for the recording location.

Solution Create a unique IP address for the recording location. For more information, contact your network administrator.

Problem Unable to decode a multicast stream using VLC media player

Cause While using RTSP, the VLC media player defaults to using unicast.

Solution Change your VLC configuration to force multicast.

- 1** Open VLC media player.
- 2** Click **Tools** → **Preferences**, then select **Show settings for all**.
- 3** Under **Input/Codecs**, select **Demuxers settings**.
- 4** Select **RTP/RTSP**, then enable **Force multicast RTP via RTSP**.
- 5** When you're done, save your changes.

Problem Unable to record to network shared folder or Network Attached Storage (NAS)

Cause An incorrect network path or IP address was specified.

Solution To make sure the network path is properly recognized by your device, we recommend you provide the full computer name or the IP address of the system where the shared folder is located.

- The full computer name is part of the Windows properties of the system. For example, the full computer name of networkserver may be *networkserver.domain.com*.
- An IP address between 192.168.0.0 and 192.168.255.255 (recommended). Also, we recommend you assign an IP address within the subnet of your network.

For more information, contact your network administrator.

16 Notes and limitations

In this section you will find the notes and limitations for the Matrox PowerStream Plus software and the associated MaeveX devices. For more release-specific information, refer to the Matrox MaeveX Release Notes document.

16.1 General

- The MaeveX 6150 and 6120 devices have been superseded by the MaeveX 6152 and 6122 devices respectively. However, the MaeveX 6150 and 6120 devices are forward compatible and are supported by the latest PowerStream Plus software and MaeveX firmware.
- A maximum of ten (10) instances of Matrox PowerStream Plus software can be running simultaneously.
- **Windows 10** – If the settings window of a device is open when your controller system returns from sleep mode, you may receive an error message that a device is no longer active. Close and reopen the settings window of that device to view the device properties.
- **Windows Server 2022 and Server 2019** – Make sure the SSDP Discovery service, network discovery, and file sharing are enabled.

16.1.1 MaeveX 7112 encoder

- In local user mode, to control a MaeveX 7112 device through the PowerStream Plus software as well as the Web UI, the same local user credentials (user name and password) must be used in both.
- Ultra low-latency encoding requires the use of RTP streaming protocol as well as unencoded LPCM audio or the Opus audio codec.
- Only one unicast or multicast stream is supported at any given time – unicast and multicast streaming are exclusive.
- Simultaneous multi-protocol streaming is not supported (MaeveX 7112 is a single-channel / single-stream encoder). Recording the stream requires the use of simultaneous RTSP streaming.
- The **Logout** option on the device settings page has no effect when used from within the PowerStream Plus software since a PowerStream Plus user is automatically logged into all of his devices (considered as normal behavior). The **Logout** option is relevant when accessed from the Web UI directly over web browsers.

16.1.2 Maevox 6100 encoder

- While using a resolution of 3840×2160 at 60 Hz, capture and encoding are supported only in YUV 4:2:0.
- 10-bit capture is supported only with source resolutions up to 1920×1200p60.
- Capture, encoding, and streaming of High-Bandwidth Digital Content Protection (HDCP) content is not supported.

16.1.3 Maevox 6152 decoder

- 4Kp60 in YUV 4:4:4 pixel format selected in PowerStream Plus at the compositing or layout stage can only be transferred to HDMI Outputs 1 and 3 (HDMI Outputs 2 and 4 cannot be used in this case).
- Frame synchronization between multiple streams is maintained by the decoder only if the streams are displayed within the same layout (could be on one output, or across multiple joined outputs), and only if the source signals connected to the Maevox encoder are frame-synchronous. A private communications channel with a Maevox 6100 series encoder enables this synchronization between multiple streams.
- If protected content support is enabled in PowerStream Plus, the respective devices will protect all their outgoing streams, which can only be decoded and displayed by Maevox 6152 decoders that are also enabled for protected content support. Protocols that can carry protected content are restricted to RTSP and RTP only. Other streaming protocols are not supported in this mode. The local DisplayPort monitoring output, as well as the recording function will be inaccessible (unsupported) in this mode. A warning message will be displayed if any of these options are in use and have to be disabled before enabling protected content support.
- For low latency, the Maevox 6100 Series encoder must be set up to encode the captured stream without video scaling, composition, or modification in the color procAmps, and the **Encoding mode** should be set to either **Optimized for low latency**, or **Optimized for desktop** in the PowerStream Plus software. The decoder has to be set up to decode the video stream without video scaling, composition, or modification in the color procAmps, and display it directly onto the monitor, which has to be set at the same resolution and refresh rate as the stream. The decoder must have a single stream, single output configuration, and the audio and video should be from the same stream. The **Overlay** options (**Enable to display the media names over the screen** and **Enable to display the audio icons over the screen**) should not be selected.
- Custom streams with credentials (RTSP with authentication or SRT with a passphrase) cannot be reused by a different user, or from a PowerStream Plus that runs on another PC. The other PowerStream Plus users must create their own custom stream pointing to the same source with the appropriate stream credentials.

- For 4k60 resolution, a certified premium high-speed HDMI cable is highly recommended.
- If a Maevox 6152 decoder is configured with four (4) times the same output resolution, for example, 1920 x 1080 or 3840 x 2160, and the failsafe feature is used, it is recommended to select a failsafe video file that has the same resolution as the outputs, that is, 1920 x 1080 or 3840 x 2160. In the case of a resolution mismatch, scaling will occur, and depending on the output configuration, the failsafe content may have dropped frames or reduced frame rate. Alternatively, a still image can be used as a failsafe content.
- The maximum decoding, scaling, and compositing capability of the device is 4x 4k30 or 2x 4k60 (or equivalent). The **CPU**, **Video decoding**, and **Video processing** percentages are displayed in the **Telemetry** section of the device information dashboard in PowerStream Plus. In order to avoid potential frame drop and/or image stutter, it is highly recommended to maintain all processing under 100% at all times. This can be accomplished by defining configurations that are within the processing capabilities of the device. For example, unnecessary scaling can be avoided by trying to match the stream resolutions (including that of the failsafe content) to the resolutions of the various output surfaces.

16.1.4 Maevox 6100 Series (6152 / 6122 / 6100) encoders

- Interlaced video input is converted to progressive mode before encoding. Only the local pass through output will be interlaced (same as input signal).

16.1.5 Maevox 5150 encoder

- Decoding streams encoded by the Maevox 7112 encoders are currently not supported.
- Changing the display resolution of your monitors while your encoder or decoder are outputting to your monitors may cause your devices to fail.
- If an encoder isn't properly disconnected, decoders connected to this encoder device may still attempt to connect to it.
- The analog audio volume on the decoder device may be higher than on the encoder device, even though the volume on both devices is set to the same level.
- An encoder supports up to 8 simultaneous streams (1080p at 15Mb/s). When counting streams, a multicast stream is a unique stream (equivalent to an unicast stream) regardless of the number of decoders receiving that stream.

16.2 Protected content

- Video capture and streaming or decoding of protected content is only supported with the Maevox 6152 and 6122 encoders and the Maevox 6152 decoder.
- A decoder with the protected content support enabled will also decode non-protected content from a Maevox 6100 Series encoder with protected content unsupported or turned off, or from any other third-party encoder source. Such a decoder will only provide HDMI signal and content to HDCP-capable devices.

16.2.1 Maevox 6152 and 6122 encoders

- Protected content streamed by a Maevox 6100 Series encoder can only be decoded by a Maevox 6100 Series decoder and the protocol must be RTSP or RTP (MPEG-2 TS, HLS, RTMP, and SRT protocols don't support streaming of protected content).
- Streaming over WAN of HDCP protected content is not supported.

16.2.2 Maevox 6152 decoder

- If protected content support is enabled in PowerStream Plus on a given device:
 - All HDMI outputs will be HDCP protected and non-HDCP display devices will not receive any signal. Such a decoder will decode protected streams originating from Maevox 6152 and 6122 encoders enabled for protected content support, as well as unprotected streams from any Maevox or compatible third-party encoders.
 - If any protected source content is mapped to be displayed on a 33rd display device, the corresponding decoder will stop decoding this content and will replace it with a blank surface if used on any of its outputs (or with failsafe content if failsafe is enabled).
- If protected content support is disabled on a given device (turned Off in PowerStream Plus), the Maevox decoder will **not** decode any streams originating from Maevox 6152 or 6122 encoders with protected content support enabled.

16.3 Audio

- Maevox 6100 Series encoder appliances – Using analog and digital (HDMI) audio simultaneously from the same input channel isn't supported.
- Maevox 5150 encoder – Audio cuts out briefly when enabling or disabling the **Use pass through** option.

- Playback of content with different audio sampling rates may cause issues with third-party players (such as VLC).

16.4 Recording

- **All Maevox encoder appliances** – When recording, make sure there’s enough available space on the destination device (USB memory or network drive) before starting to record. If the recorded file becomes larger than the available space, the recording file won’t be able to close and the data won’t be readable.
- **Maevox 6152 and 6122 encoder appliances** – When the device is enabled for protected content (HDCP) support, the recording function will be inaccessible (not supported).

16.5 Date and time

- PowerStream Plus updates the date and time information of your device every two (2) seconds.
- **Maevox 6152 decoder** – It is strongly advised to have a valid NTP server. If a valid NTP server is not available, PowerStream Plus uses the clock on the PC to update the device, which may cause some features to not work properly.

16.6 Network

- If your network is slow, congested, or experiencing high traffic, your recording may fail. For more information, contact your network administrator.
- If a decoder uses a stream from an encoder located on a different subnet, the quality of the video output from the decoder may be degraded.
- When transmitting in multicast on a large network, we recommend using a router with multicast addressing support and switches with IGMP v2 support.
- Slow response from certain routers may cause a slow device detection in PowerStream Plus.
- **Windows 10** – If your controller system doesn’t have access to a DNS (Domain Name System) server, or if response from its DNS server is slow, PowerStream Plus may take a long time to start up (several minutes). To avoid this delay, configure your controller system to use a fixed IP address (such as local host 127.0.0.1) as its DNS server. For more information, see “PowerStream Plus may be slow to start”, [page 177](#).

17 Appendix – Firewall requirements

The following are the firewall requirements for your controller system and for a network with a Maevox environment.

17.1 PowerStream Plus software

The following are the firewall requirements for your controller system.

Network Ports	Type	Inbound	Outbound	Functionality
20, 21	TCP	—	✓	FTP: Failsafe file upload*
53	TCP	—	✓	DNS: DNS requests
443†	TCP	—	✓	HTTPS: PowerStream Plus commands
1900, 1910†	UDP	✓	✓	UPnP: Microsoft SSDP for discovery of UPnP devices

Note: ICMP must be enabled (ping)

* Maevox 6152 and 5150 decoders only.

† Minimum requirements.

17.2 Firmware updater

The following are the firewall requirement for a system running the Matrox Firmware Updater.

Network Ports	Type	Inbound	Outbound	Functionality
20, 21	TCP	—	✓	FTP: Firmware file transfer to devices
22*	TCP	✓	✓	SSH: Firmware update commands
443*	TCP	—	✓	HTTPS: Authentication and firmware update commands
1900, 1910*	UDP	✓	✓	UPnP: Microsoft SSDP for discovery of UPnP devices

* Minimum requirements.

Note: Ports 20, 21, and 22 are not required for Maevox 7112. Ports 443, 1900, and 1910 are necessary for Maevox 7112.

17.3 Maevox devices

The following are the requirements for a network firewall present on a network with a Maevox environment.

Network Ports	Type	Inbound	Outbound	Functionality
20, 21	TCP	✓	—	FTP: Failsafe file upload
22*	TCP	✓	✓	SSH: Firmware update commands
69	UDP	—	✓	DHCP: DHCP client
123	UDP	✓	✓	NTP: Network Time Protocol
161	UDP	✓	✓	SNMP: Network management (public community string)
443*	TCP	✓	—	HTTPS: PowerStream Plus commands, and authentication and firmware update
1900*	UDP	✓	✓	UPnP: Microsoft SSDP for discovery of UPnP devices
Ephemeral†	UDP	✓	✓	RTP/RTCP: Audio and video streams and control
8554 (Maevox 5150)	TCP	✓	✓	RTSP: Streaming (configurable)†
3049 (Maevox 6100)*				
554 (Maevox 7112)				
12000‡	TCP	✓	✓	RS232: RS232 virtualization§

* Minimum requirements for the 6100 and 5100 series only.

† For more information, see “11.1.5.1 - Stream to network”, page 149 for Maevox 5150, see “10.1.6 - Streams”, page 140 for Maevox 6100, and see “6.2.2.4 - RTSP streaming”, page 51 for Maevox 7112.

‡ Fixed value when using the **Relayed serial over IP** feature in PowerStream Plus. User defined when using the **Direct serial over IP** feature in PowerStream Plus.

§ Not applicable to the Maevox 6100 encoder card and the Maevox 7112 encoder.

17.4 Accessing your Windows Firewall settings



Note: You may need administrator rights to modify your Windows Firewall settings. For more information, see Windows documentation or contact your system administrator.

To access your Windows Firewall settings:

Windows 11/10

- 1 Windows 11 – Click **Start** → **Settings** → **Network & Internet** → **Ethernet** → **Configure Firewall and security settings**.
Windows 10 – Click **Start** → **Settings** → **Network & Internet** → **Ethernet** → **Windows Firewall**.
- 2 Windows 11/10 – In the left panel, click **Advanced Settings**.

17.5 Adding rules to your Windows Firewall settings



Note: You may need administrator rights to modify your Windows Firewall settings. For more information, see Windows documentation or contact your system administrator.

Windows 11/10

- 1 Windows 11 – Click **Start** → **Settings** → **Network & Internet** → **Ethernet** → **Configure Firewall and security settings**.
Windows 10 – Click **Start** → **Settings** → **Network & Internet** → **Ethernet** → **Windows Firewall**.
- 2 Windows 11/10 – In the left panel, click **Advanced Settings**.
- 3 Click **Inbound Rules**.
- 4 In the **Actions** panel, click **New Rule**. Configure the new rule with the following settings:
 - **Rule** – Select **Custom**.
 - **Program** – Select **All programs**.
 - **Protocol and Ports** – Next to **Protocol**, select **TCP**. Next to **Local port**, select **Specific ports**. For the port number, enter **445**. Next to **Remote port**, select **All Ports**.
 - **Scope** – Under the remote IP address, add the IP range you want to use for your encoders. You can use a range (such as *192.168.1.0/24*) or a single IP address (such as *192.152.168.62*).
 - **Action** – Select **Allow the connection**.

- **Profile** – Select the network location of your system (**Domain**, **Private**, or **Public**).
 - **Name** – Enter the name for your rule (such as *Maevex Encoder Recording – TCP rule*).
- 5** In the **Actions** panel, click **New Rule**. Configure the new rule with the following settings:
- **Rule type** – Select **Custom**.
 - **Program** – Select **All programs**.
 - **Protocol and Ports** – Under **Protocol type**, select **ICMPv4**.
 - **Scope** – Under the remote IP address, add the IP range you want to use for your encoders. You can use a range (such as *192.168.1.0/24*) or a single IP address (such as *192.152.168.62*).
 - **Action** – Select **Allow the connection**.
 - **Profile** – Select the network location of your system (**Domain**, **Private**, or **Public**).
 - **Name** – Enter the name for your rule (such as *Maevex Encoder Recording – ICMPv4 rule*).

For more information, see your network administrator.

18 Customer support

18.1 Matrox web

Our web site has product literature, press releases, technical material, a sales office list, trade show information, and other relevant material. Visit the Matrox Graphics Web site at video.matrox.com.

18.2 Technical support

Matrox values your business and offers professional support for your Matrox product.

If your product was purchased through a Matrox dealer, contact your dealer for product support. This is the quickest and most effective method of technical assistance. Your dealer is familiar with your complete system.

If your product was purchased through Matrox, contact your Matrox representative or visit our technical support Web site at video.matrox.com/support.

18.2.1 Information we need

Please give a complete description of the problem, and include:

- Matrox product serial number, model number, revision number, and firmware number.
- Source specifications.
- Controller system (system running PowerStream) specifications.
- Specific PowerStream Plus options and features used.
- Decoding software and/or hardware.

18.3 Firmware package

A more recent firmware package may support more features and may offer increased capabilities. To obtain the latest firmware package, see the Matrox Web site (video.matrox.com/maevexsw).

18.4 View your warranty information

Matrox makes warranty information available on the Matrox site (video.matrox.com/support/warranty/).

18.5 View the third party software notices

Matrox makes third party software notices and/or additional terms and conditions available on the Matrox site (<https://thirdpartylicenses.matrox.com>).

18.6 Register your Matrox product

Please register online (video.matrox.com/apps/registration) to be eligible for customer support, new product announcements, and information on special offers and upcoming events.

USA

FCC Compliance Statement

Remark for the Matrox hardware products supported by this guide This equipment has been tested and found to comply with the limits for a Class A digital device, pursuant to Part 15 of the FCC Rules. These limits are designed to provide reasonable protection against harmful interference when the equipment is operated in a commercial environment. This equipment generates, uses, and can radiate radio frequency energy and, if not installed and used in accordance with the instructions manual, may cause harmful interference to radio communications. Operation of this equipment in a residential area is likely to cause harmful interference in which case the user will be required to correct the interference at his own expense.

WARNING Changes or modifications to this unit not expressly approved by the party responsible for the compliance could void the user's authority to operate this equipment. The use of shielded cables for connection of the monitor to the card is required to meet FCC requirements.

CANADA

(English) Innovation, Science and Economic Development Canada

Remark for the Matrox hardware products supported by this guide These digital apparatus does not exceed the Class A limits for radio noise emission from digital devices set out in the Radio Interference Regulation of Innovation, Science and Economic Development Canada.

(Français) Innovation, Sciences et Développement économique Canada

Remarque sur les produits matériels Matrox couverts par ce guide Ce présent appareil numérique n'émet aucun bruit radioélectrique dépassant les limites applicables aux appareils numériques de Classe A prescrites dans le Règlement sur le brouillage radioélectrique édicté par Innovation, Sciences et Développement économique Canada.

UNITED KINGDOM

United Kingdom user's information – Declaration of Conformity

Remark for the Matrox hardware products supported by this guide These devices comply with Directive UK SI 2016 No. 1091 relating to electromagnetic compatibility for a Class A digital device. They have been tested and found to comply with EN55032/CISPR32 and EN55035/CISPR35. In a domestic environment these products may cause radio interference in which case the user may be required to take adequate measures. To meet UK requirements, shielded cables must be used to connect the monitor and other peripherals to the card. These products have been tested in a typical class A compliant host system. It is assumed that these products will also achieve compliance in any class A compliant system.

JAPAN

VCCI Compliance Statement

Remark for the Matrox hardware products supported by this guide This is a Class A product based on the standard of the Voluntary Control Council for Interference by Information Technology Equipment (VCCI). If this equipment is used in a domestic environment, radio disturbance may occur, in which case, the user may be required to take corrective actions.

この装置は、クラスA情報技術装置です。この装置を家庭環境で使用すると電波妨害を引き起こすことがあります。この場合には使用者が適切な対策を講ずるよう要求されることがあります。 VCCI-A

A 급 기기 (업무용 방송통신기자재)

이 기기는 업무용 (A 급) 전자파적합기기로서 판 매자 또는 사용자는 이 점을 주의하시기 바
라 며, 가정외의 지역에서 사용하는 것을 목 적 으 로 합 니 다 .

(English) European user's information – Declaration of Conformity

Remark for the Matrox hardware products supported by this guide These devices comply with EC Directive 2014/30/EU for a Class A digital device. They have been tested and found to comply with EN55032/CISPR32 and EN55035/CISPR35. In a domestic environment these products may cause radio interference in which case the user may be required to take adequate measures. To meet EC requirements, shielded cables must be used to connect the monitor and other peripherals to the card. These products have been tested in a typical class A compliant host system. It is assumed that these products will also achieve compliance in any class A compliant system.

(Français) Informations aux utilisateurs Européens – Déclaration de conformité

Remarque sur les produits matériels Matrox couverts par ce guide Ces unités sont conformes à la directive communautaire 2014/30/EU pour les unités numériques de classe A. Les tests effectués ont prouvé qu'elles sont conformes aux normes EN55032/CISPR32 et EN55035/CISPR35. Le fonctionnement de ces produits dans un environnement résidentiel peut causer des interférences radio, dans ce cas l'utilisateur peut être amené à prendre les mesures appropriées. Pour respecter les impératifs communautaires, les câbles de connexion entre le moniteur ou autres périphériques et la carte doivent être blindés. Ces produits ont été testés dans un système hôte typique compatible classe A. On suppose qu'ils présenteront la même compatibilité dans tout système compatible classe A.

(Deutsch) Information für europäische Anwender – Konformitätserklärung

Anmerkung für die Matrox Hardware-Produktunterstützung durch dieses Handbuch Diese Geräte entsprechen EC Direktive 2014/30/EU für ein digitales Gerät Klasse A. Sie wurden getestet und entsprechen demnach EN55032/CISPR32 und EN55035/CISPR35. In einer Wohnumgebung können diese Produkte Funkinterferenzen erzeugen, und der Benutzer kann genötigt sein, entsprechende Maßnahmen zu ergreifen. Um EG-Anforderungen zu entsprechen, müssen zum Anschließen des Monitors und anderer Peripheriegeräte an die Karte abgeschirmte Kabel verwendet werden. Diese Produkte wurden in einem typischen, der Klasse A entsprechenden, Host-System getestet. Es wird davon ausgegangen, daß diese Produkte auch in jedem Klasse A entsprechenden System entsprechend funktionieren.

(Italiano) Informazioni per gli utenti europei – Dichiarazione di conformità

Nota per i prodotti hardware Matrox supportati da questa guida Questi dispositivi sono conformi alla direttiva CEE 2014/30/EU relativamente ai dispositivi digitali di Classe A. Sono stati provati e sono risultati conformi alle norme EN55032/CISPR32 e EN55035/CISPR35. In un ambiente domestico, questi prodotti possono causare radiointerferenze, nel qual caso all'utente potrebbe venire richiesto di prendere le misure adeguate. Per soddisfare i requisiti CEE, il monitor e le altre periferiche vanno collegati alla scheda grafica con cavi schermati. Questi prodotti sono stati provati in un tipico sistema host conforme alla classe A. Inoltre, si dà per scontato che questi prodotti acquisiranno la conformità in qualsiasi sistema conforme alla classe A.

(Español) Información para usuarios europeos – Declaración de conformidad

Observación referente a los productos de hardware de Matrox apoyados por este manual Estos dispositivos cumplen con la directiva de la CE 2014/30/EU para dispositivos digitales de Clase A. Dichos dispositivos han sido sometidos a prueba y se ha comprobado que cumplen con las normas EN55032/CISPR32 y EN55035/CISPR35. En entornos residenciales, estos productos pueden causar interferencias en las comunicaciones por radio; en tal caso el usuario deberá adoptar las medidas adecuadas. Para satisfacer las disposiciones de la CE, deberán utilizarse cables apantallados para conectar el monitor y demás periféricos a la tarjeta. Estos productos han sido sometidos a prueba en un típico sistema anfitrión que responde a los requisitos de la clase A. Se supone que estos productos cumplirán también con las normas en cualquier sistema que responda a los requisitos de la clase A.

EUROPE

(English) European user's information – Directive on Waste Electrical and Electronic Equipment (WEEE)

Please refer to the Matrox Web site (www.matrox.com/environment/en/weee) for recycling information.



(Français) Informations aux utilisateurs Européens – Règlementation des déchets d'équipements électriques et électroniques (DEEE)

Se référer au site Web de Matrox (www.matrox.com/environment/en/weee) pour l'information concernant le recyclage.

(Deutsch) Information für europäische Anwender – Europäische Regelungen zu Elektro- und Elektronikgeräten (WEEE)

Bitte wenden Sie sich an der Matrox-Website (www.matrox.com/environment/en/weee) für Recycling-Informationen.

(Italiano) Informazioni per gli utenti europei – Direttiva sui rifiuti di apparecchiature elettriche ed elettroniche (RAEE)

Si prega di riferirsi al sito Web Matrox (www.matrox.com/environment/en/weee) per le informazioni di riciclaggio.

FRANCE

Avertissement sur l'épilepsie

À lire avant toute utilisation d'un jeu vidéo par vous-même ou votre enfant Certaines personnes sont susceptibles de faire des crises d'épilepsie ou d'avoir des pertes de conscience à la vue de certains types de lumières clignotantes ou d'éléments fréquents dans notre environnement quotidien. Ces personnes s'exposent à des crises lorsqu'elles regardent certaines images télévisées ou qu'elles jouent à certains jeux vidéo. Ces phénomènes peuvent apparaître alors même que le sujet n'a pas d'antécédent médical ou n'a jamais été confronté à une crise d'épilepsie.

Si vous-même ou un membre de votre famille avez déjà présenté des symptômes liés à l'épilepsie (crise ou perte de conscience) en présence de stimulations lumineuses, veuillez consulter votre médecin avant toute utilisation.

Nous conseillons aux parents d'être attentifs à leurs enfants lorsqu'ils jouent avec des jeux vidéo. Si vous-même ou votre enfant présentez un des symptômes suivants: vertige, trouble de la vision, contraction des yeux ou des muscles, perte de conscience, trouble de l'orientation, mouvement involontaire ou convulsion, veuillez immédiatement cesser de jouer et consultez un médecin.

Précautions à prendre dans tous les cas pour l'utilisation d'un jeu vidéo Ne vous tenez pas trop près de l'écran.

- Jouez à bonne distance de l'écran de TV et aussi loin que le permet le cordon de raccordement.
- Utilisez de préférence les jeux de vidéo sur un écran de petite taille.
- Évitez de jouer si vous êtes fatigué ou si vous manquez de sommeil.
- Assurez-vous que vous jouez dans une pièce bien éclairée.
- En cours d'utilisation, faites des pauses de dix à quinze minutes toutes les heures.

USA

FCC Compliance Statement



Remark for the Matrox hardware products supported by this guide This equipment has been tested and found to comply with the limits for a Class B digital device, pursuant to Part 15 of the FCC Rules. These limits are designed to provide reasonable protection against harmful interference in a residential installation. This equipment generates, uses and can radiate radio frequency energy and, if not installed and used in accordance with the instructions, may cause harmful interference to radio communications. However, there is no guarantee that interference will not occur in a particular installation. If this equipment causes harmful interference to radio or television reception, which can be determined by turning the equipment off and on, the user is encouraged to try to correct the interference by one or more of the following measures: • Reorient or relocate the receiving antenna • Increase the separation between the equipment and receiver • Connect the equipment into an outlet on a circuit different from that to which the receiver is connected • Consult the dealer or an experienced radio/TV technician for help.

WARNING Changes or modifications to this unit not expressly approved by the party responsible for the compliance could void the user's authority to operate this equipment.

Declaration of conformity of a Class B digital device according to the FCC rules

We, the Responsible Party Matrox, 2002 Ridge Road, Champlain, NY 12919 • Telephone: (514) 822-6000 (extension 2026) • Attention: Conformity Group Matrox

Declaration The Matrox hardware products supported by this guide comply with Part 15 of the FCC Rules. Operation is subject to the following two conditions: (1) these devices may not cause harmful interference, and (2) these devices must accept any interference received, including interference that may cause undesired operation. Any question regarding this declaration should be forwarded to the above coordinates.

CANADA

(English) Innovation, Science and Economic Development Canada

Remark for the Matrox hardware products supported by this guide These digital devices do not exceed the Class B limits for radio noise emission from digital devices set out in the Radio Interference Regulation of Innovation, Science and Economic Development Canada.

(Français) Innovation, Sciences et Développement économique Canada

Remarque sur les produits matériels Matrox couverts par ce guide Ces appareils numériques n'émettent aucun bruit radioélectrique dépassant les limites applicables aux appareils numériques de Classe B prescrites dans le Règlement sur le brouillage radioélectrique édicté par Innovation, Sciences et Développement économique Canada.

USA

FCC Compliance Statement

Remark for the Matrox hardware products supported by this guide This equipment has been tested and found to comply with the limits for a Class A digital device, pursuant to Part 15 of the FCC Rules. These limits are designed to provide reasonable protection against harmful interference when the equipment is operated in a commercial environment. This equipment generates, uses, and can radiate radio frequency energy and, if not installed and used in accordance with the instructions manual, may cause harmful interference to radio communications. Operation of this equipment in a residential area is likely to cause harmful interference in which case the user will be required to correct the interference at his own expense.

WARNING Changes or modifications to this unit not expressly approved by the party responsible for the compliance could void the user's authority to operate this equipment. The use of shielded cables for connection of the monitor to the card is required to meet FCC requirements.

CANADA

(English) Innovation, Science and Economic Development Canada

Remark for the Matrox hardware products supported by this guide These digital apparatus does not exceed the Class A limits for radio noise emission from digital devices set out in the Radio Interference Regulation of Innovation, Science and Economic Development Canada.

(Français) Innovation, Sciences et Développement économique Canada

Remarque sur les produits matériels Matrox couverts par ce guide Ce présent appareil numérique n'émet aucun bruit radioélectrique dépassant les limites applicables aux appareils numériques de Classe A prescrites dans le Règlement sur le brouillage radioélectrique édicté par Innovation, Sciences et Développement économique Canada.

UNITED KINGDOM

United Kingdom user's information – Declaration of Conformity

Remark for the Matrox hardware products supported by this guide These devices comply with Directive UK SI 2016 No. 1091 relating to electromagnetic compatibility for a Class A digital device. They have been tested and found to comply with EN55032/CISPR32 and EN55035/CISPR35. In a domestic environment these products may cause radio interference in which case the user may be required to take adequate measures. To meet UK requirements, shielded cables must be used to connect the monitor and other peripherals to the card. These products have been tested in a typical class A compliant host system. It is assumed that these products will also achieve compliance in any class A compliant system.

JAPAN

VCCI Compliance Statement

Remark for the Matrox hardware products supported by this guide This is a Class B product based on the standard of the Voluntary Control Council for Interference from Information Technology Equipment (VCCI). If this is used near a radio or television receiver in a domestic environment, it may cause radio interference. Install and use the equipment according to the instruction manual.



この装置は、クラスB情報技術装置です。この装置は、家庭環境で使用することを目的としていますが、この装置がラジオやテレビジョン受信機に近接して使用されると、受信障害を引き起こすことがあります。

取扱説明書に従って正しい取り扱いをして下さい。 VCCI-B

KOREA

B 급 기기 (가정용 방송통신기자재)

이 기기는 가정용 (B 급) 전자파적합기기로서 주로 가정에서 사용하는 것을 목적으로 하며, 모든 지역에서 사용할 수 있습니다.

EUROPE

(English) European user's information – Information on Conformity

Remark for the Matrox hardware products supported by this guide These devices comply with EC Directive 2014/30/EU for a Class B digital device. They have been tested and found to comply with EN55032/CISPR32 and EN55024/CISPR24. In a domestic environment these products may cause radio interference in which case the user may be required to take adequate measures. These products have been tested in a typical class B compliant host system. It is assumed that these products will also achieve compliance in any class B compliant system.



(Français) Informations aux utilisateurs Européens – Informations sur la conformité

Remarque sur les produits matériels Matrox couverts par ce guide Ces unités sont conformes à la directive communautaire 2014/30/EU pour les unités numériques de classe B. Les tests effectués ont prouvé qu'elles sont conformes aux normes EN55032/CISPR32 et EN55024/CISPR24. Le fonctionnement de ces produits dans un environnement résidentiel peut causer des interférences radio, dans ce cas l'utilisateur peut être amené à prendre les

mesures appropriées. Ces produits ont été testés dans un système hôte typique compatible classe B. On suppose qu'ils présenteront la même compatibilité dans tout système compatible classe B.

(Deutsch) Information für europäische Anwender – Konformitäts-Informationen

Anmerkung für die Matrox Hardware-Produktunterstützung durch dieses Handbuch Diese Geräte entsprechen EC Direktive 2014/30/EU für ein digitales Gerät Klasse B. Sie wurden getestet und entsprechen demnach EN55032/CISPR32 und EN55024/CISPR24. In einer Wohnumgebung können diese Produkte Funkinterferenzen erzeugen, und der Benutzer kann genötigt sein, entsprechende Maßnahmen zu ergreifen. Diese Produkt wurden in einem typischen, der Klasse B entsprechenden, Host-System getestet. Es wird davon ausgegangen, daß diese Produkte auch in jedem Klasse B entsprechenden System entsprechend funktionieren.

(Italiano) Informazioni per gli utenti europei – Informazioni sulla conformità

Nota per i prodotti hardware Matrox supportati da questa guida Questi dispositivi sono conformi alla direttiva CEE 2014/30/EU relativamente ai dispositivi digitali di Classe B. Sono stati provati e sono risultati conformi alle norme EN55032/CISPR32 e EN55024/CISPR24. In un ambiente domestico, questi prodotti possono causare radiointerferenze, nel qual caso all'utente potrebbe venire richiesto di prendere le misure adeguate. Questi prodotti sono stati provati in un tipico sistema host conforme alla classe B. Inoltre, si dà per scontato che questi prodotti acquisiranno la conformità in qualsiasi sistema conforme alla classe B.

(Español) Información para usuarios europeos – Información sobre la conformidad

Observación referente a los productos de hardware de Matrox apoyados por este manual Estos dispositivos cumplen con la directiva de la CE 2014/30/EU para dispositivos digitales de Clase B. Dichos dispositivos han sido sometidos a prueba y se ha comprobado que cumplen con las normas EN55032/CISPR32 y EN55024/CISPR24. En entornos residenciales, estos productos pueden causar interferencias en las comunicaciones por radio; en tal caso el usuario deberá adoptar las medidas adecuadas. Se supone que estos productos cumplirán también con las normas en cualquier sistema que responda a los requisitos de la clase B.

EUROPE

(English) European user's information – Directive on Waste Electrical and Electronic Equipment (WEEE)

Please refer to the Matrox Web site (www.matrox.com/environment/en/weee) for recycling information.



(Français) Informations aux utilisateurs Européens – Règlementation des déchets d'équipements électriques et électroniques (DEEE)

Se référer au site Web de Matrox (www.matrox.com/environment/en/weee) pour l'information concernant le recyclage.

(Deutsch) Information für europäische Anwender – Europäische Regelungen zu Elektro- und Elektronikaltgeräten (WEEE)

Bitte wenden Sie sich an der Matrox-Website (www.matrox.com/environment/en/weee) für Recycling-Informationen.

(Italiano) Informazioni per gli utenti europei – Direttiva sui rifiuti di apparecchiature elettriche ed elettroniche (RAEE)

Si prega di riferirsi al sito Web Matrox (www.matrox.com/environment/en/weee) per le informazioni di riciclaggio.

FRANCE

Avertissement sur l'épilepsie

À lire avant toute utilisation d'un jeu vidéo par vous-même ou votre enfant Certaines personnes sont susceptibles de faire des crises d'épilepsie ou d'avoir des pertes de conscience à la vue de certains types de lumières clignotantes ou d'éléments fréquents dans notre environnement quotidien. Ces personnes s'exposent à des crises lorsqu'elles regardent certaines images télévisées ou qu'elles jouent à certains jeux vidéo. Ces phénomènes peuvent apparaître alors même que le sujet n'a pas d'antécédent médical ou n'a jamais été confronté à une crise d'épilepsie.

Si vous-même ou un membre de votre famille avez déjà présenté des symptômes liés à l'épilepsie (crise ou perte de conscience) en présence de stimulations lumineuses, veuillez consulter votre médecin avant toute utilisation.

Nous conseillons aux parents d'être attentifs à leurs enfants lorsqu'ils jouent avec des jeux vidéo. Si vous-même ou votre enfant présentez un des symptômes suivants: vertige, trouble de la vision, contraction des yeux ou des muscles, perte de conscience, trouble de l'orientation, mouvement involontaire ou convulsion, veuillez immédiatement cesser de jouer et consultez un médecin.

Précautions à prendre dans tous les cas pour l'utilisation d'un jeu vidéo Ne vous tenez pas trop près de l'écran.

- Jouez à bonne distance de l'écran de TV et aussi loin que le permet le cordon de raccordement.
- Utilisez de préférence les jeux de vidéo sur un écran de petite taille.
- Évitez de jouer si vous êtes fatigué ou si vous manquez de sommeil.
- Assurez-vous que vous jouez dans une pièce bien éclairée.
- En cours d'utilisation, faites des pauses de dix à quinze minutes toutes les heures.

Trademarks • Marques déposées • Warenzeichen • Marchi registrati • Marcas registradas

Matrox Electronic Systems Ltd. /

Matrox Graphics Inc.	Matrox®, DualHead®, Avio™, C-Series™, D-Series™, DualHead2Go™, Extio™, G400™, G450™, G550™, GXM™, Maevex™, Marvel™, MED2mp™, MED2mp-DVI™, MED3mp-DVI™, MED4mp™, MED5mp-DVI™, MED5mp™, Millennium™, MMS™, Multi-Monitor Series™, MultiDesk™, Mura™, MuraControl™, Mystique™, P650™, P690™, P750™, Parhelia™, Parhelia™ APVe, Parhelia-512™, Parhelia-LX™, Parhelia HR256™, PJ4OLP™, QID™, Quad Information Display™, RAD™, Quick Connect™, MaxVIEW™, Onyx™, PixelTOUCH™, PrecisionCAD™, Precision SGT™, QuadHead2Go™, QuickDesk™, RAD2mp™, RAD3mp™, RAD9mp™, RADQ2mp™, Rainbow Runner®, TheatreVUE™, TripleHead™, TripleHead2Go™, VDA™, Veos™, Xenia™
Adobe Systems Inc.	Acrobat®, Reader®
Advanced Micro Devices, Inc.	AMD®
Apple Computer, Inc.	App Store®, Apple®, iPad®, Mac®, Mac OS®
Belden Inc.	Belden®
Dolby Laboratories, Inc.	Dolby®, Dolby Digital®
Facebook, Inc.	Facebook®
Google, Inc.	YouTube®
HDMI Licensing LLC	HDMI®
Intel Corporation	Intel®
International Business Machines	IBM Video Streaming™
Linus Torvalds.	Linux®
Microsoft Corporation.	Active Directory®, Aero®, Direct3D®, DirectShow®, DirectX®, Microsoft®, MS-DOS®, PowerPoint®, Windows®, Windows NT®, Windows Server®, Windows Vista®
NVIDIA Corporation	NVIDIA®
Panopto, Inc.	Panopto™
PCI-SIG.	PCI™, PCI-X®, PCIe®, PCI Express®
Radio Corporation of America	RCA®
RealVNC Ltd.	VNC®
Restream, Inc.	Restream™
SD-3C, LLC.	SD™, SDHC™, SDXC™
Silicon Graphics, Inc.	OpenGL®
Silicon Image, Inc.	PanelLink®, TMDS®
Twitch Interactive, Inc.	Twitch™
U.S. Environmental Protection Agency.	ENERGY STAR®
Video Electronics Standards Association	DisplayPort™
VideoLAN	VideoLAN®, VLC®, VLC® media player
Vimeo, LLC	Vimeo®

Wibu-Systems..... WIBU®
Wowza Media Systems, LLC..... Wowza™

Copyright © 1996-2020 VideoLAN. This logo or a modified version may be used or modified by anyone to refer to the VideoLAN project or any product developed by the VideoLAN team, but does not indicate endorsement by the project.

HTML5 Logo by World Wide Web Consortium ([W3C](http://www.w3.org)). This HTML5 logo is licensed under this Public License (<http://www.creativecommons.org/licenses/by/3.0/legalcode>). The logo has been modified to meet the resolution and size required by this application.

• (English) Registered trademarks are registered in the United States, Canada, and/or other countries. All other nationally and internationally recognized trademarks and tradenames are hereby acknowledged. • (Français) Les marques déposées sont déposées aux États-Unis, au Canada et/ou dans d'autres pays. Toutes les autres marques et tous les autres noms déposés reconnus nationalement ou internationalement sont également reconnus par les présentes. • (Deutsch) Die eingetragenen Warenzeichen sind in den USA, Kanada und/oder anderen Ländern registriert. Alle sonstigen national und international bekannten Warenzeichen und Produktnamen werden hiermit anerkannt. • (Italiano) I marchi registrati sono registrati negli Stati Uniti, in Canada e/o in altri paesi. Tutti gli altri marchi registrati e nomi commerciali riconosciuti a livello nazionale e internazionale sono ugualmente riconosciuti qui. • (Español) Las marcas registradas están registradas en los EE.UU., Canadá u otros países. Por medio del presente se reconocen todas las demás marcas y nombres comerciales reconocidos a nivel nacional e internacional.

(English) Disclaimer

THE INFORMATION IN THIS GUIDE IS SUBJECT TO CHANGE AT ANY TIME AND WITHOUT NOTICE.

Matrox Graphics Inc. reserves the right to make changes in specifications at any time and without notice. The information provided by this document is believed to be accurate and reliable at the time it is written. However, no responsibility is assumed by Matrox Graphics Inc. for its use, for its reproduction and/or distribution, in whole or in part; nor for any infringements of patents or other rights of third parties resulting from its use.

(Français) Responsabilité

LES INFORMATIONS CONTENUES DANS CE MANUEL PEUVENT ÊTRE MODIFIÉES EN TOUT TEMPS ET CE SANS PRÉAVIS.

Les Graphiques Matrox Inc. se réserve le droit de modifier les spécifications en tout temps et ce sans préavis quelconque. Les informations contenues dans ce manuel sont reconnues comme étant précises et fiables à la date de rédaction. Cependant, Matrox Graphics Inc. n'assume aucune responsabilité concernant leur utilisation, leur reproduction et/ou distribution, en tout ou en partie, ni leur contrefaçon de brevets ou de tout autre droit appartenant à des tiers résultant de leur utilisation. Aucune licence n'est accordée sur aucun brevet ou droit d'exploiter un brevet de Matrox Graphics Inc.

(Deutsch) Haftungsablehnungserklärung

DIE IN DIESEM HANDBUCH ENTHALTENEN ANGABEN UND DATEN KÖNNEN OHNE VORHERIGE ANKÜNDIGUNG GEÄNDERT WERDEN.

Die Matrox Graphics Inc. behält sich das Recht vor, jederzeit und ohne Ankündigung technische Daten zu ändern. Zum Zeitpunkt der Erstellung dieses Handbuchs sind die Inhalte korrekt und verlässlich. Weiterhin übernimmt Matrox Graphics Inc. keinerlei Verantwortung für die Benutzung dieses Handbuchs, die Vervielfältigung und/oder Verteilung im Ganzen oder zum Teil; weder für Verstöße gegen Patentrechte noch für andere Rechte Dritter, die aus seinem Gebrauch resultieren mögen. Es werden keinerlei Lizenzrechte gewährt für sämtliche Patente oder Patentrechte der Matrox Graphics Inc.

(Italiano) Discrezionalità

LE INFORMAZIONI CONTENUTE NEL PRESENTE DOCUMENTO SONO SOGGETTE A MODIFICHE IN QUALUNQUE MOMENTO E SENZA PREAVVISO.

Matrox Graphics Inc. si riserva il diritto di apportare variazioni di qualunque tipo alle specifiche tecniche in qualunque momento e senza alcun preavviso. Le informazioni contenute in questa documentazione sono ritenute corrette e attendibili al momento della pubblicazione. In ogni caso, non è imputabile a Matrox Graphics Inc. nessuna responsabilità per il loro utilizzo, per la loro distribuzione e/o riproduzione completa o in parte, come nessuna violazione a brevetti o diritti di altri produttori derivante dal loro utilizzo.

(Español) Renuncia

LA INFORMACION QUE CONTIENE EL PRESENTE MANUAL ESTA SUJETA A CAMBIOS SIN PREVIO AVISO EN CUALQUIER MOMENTO.

Matrox Graphics Inc. se reserva el derecho de realizar modificaciones en cualquier momento y sin previo aviso. La información facilitada en este documento se considera que es exacta y fiable hasta la fecha de publicación. Sin embargo, Matrox Graphics Inc. no asume ninguna responsabilidad por su uso, por su reproducción y/o distribución parcial o total; ni por cualquier infracción de patentes u otros derechos de terceras partes derivados de su uso. No se concede ninguna licencia bajo cualesquiera patentes o derechos de patentes de Matrox Graphics Inc.

Matrox Graphics Inc.

1055 Saint Regis Boulevard
Dorval, Quebec, Canada H9P 2T4
(514) 822-6000

video@matrox.com
video.matrox.com

matrox[®]
— video —