

**ENGLISH**



**Matrox® Mura™ IPX Series**  
**Matrox® Mura™ MPX Series**

**User Guide**

20129-301-0600  
2020.03.05

---

# Contents

<b>Matrox safety information .....</b>	<b>6</b>
Installation and operation.....	6
If a power supply (internal or external) was included with your product.....	6
If your product includes laser-based technology .....	7
If your product includes a battery.....	7
Repair .....	7
<b>Before you begin .....</b>	<b>8</b>
Using a validated platform .....	8
Preventing damage to your hardware.....	8
When installing your hardware.....	8
When connecting your hardware.....	8
<b>Getting started.....</b>	<b>9</b>
Hardware supplied.....	9
Software supplied.....	10
More information .....	10
<b>Setting up a display wall .....</b>	<b>11</b>
Components of a display wall setup .....	11
Setup overview.....	11
Mura IPX Series display card .....	11
Mura IPX Series capture cards.....	12
Mura IPX Series decode and display cards.....	13
Mura MPX Series.....	13
<b>Planning your display wall .....</b>	<b>14</b>
Planning the output layout of Mura MPX Series cards.....	14
Setting your card order.....	14
Setting the order of your output connectors.....	15
Using PowerDesk to manage your multi-display layout.....	15
Using a multi-display layout with an even number of columns .....	15
Using a multi-display layout with an uneven number of columns.....	16
Planning the input of Mura MPX Series and Mura IPX Series capture cards.....	16
Setting the DIP switches.....	17
<b>Installing your Matrox cards .....</b>	<b>18</b>
Step-by-step installation.....	18

Installing multiple cards .....	20
Interconnecting multiple cards (Framelock) .....	20
<b>Description of LED indicators .....</b>	<b>21</b>
Mura IPX Series cards .....	21
Network connector .....	22
Mura MPX-4/4, MPX-4/2, and MPX-4/0 .....	23
Mura MPX-V16 and MPX-V8 .....	24
Mura MPX-SDI.....	24
<b>Connecting your Mura IPX Series display card .....</b>	<b>25</b>
MURAI PXO-D4LF and MURAI PXO-D4LHF .....	25
Connection overview.....	25
Description of supported connections.....	25
<b>Connecting your Mura IPX Series capture card.....</b>	<b>27</b>
MURAI PXI-E4SF and MURAI PXI-E4SHF .....	27
Connection overview.....	27
Description of supported connections .....	27
MURAI PXI-E2MF, MURAI PXI-E2MHF, MURAI PXI-D2MF, and MURAI PXI-D2MHF .....	28
Connection overview.....	28
Description of supported connections .....	28
MURAI PXI-E4JF, MURAI PXI-E4JHF, MURAI PXI-D4JF, and MURAI PXI-D4JHF .....	29
Connection overview.....	29
Description of supported connections .....	29
<b>Connecting your Mura MPX Series card .....</b>	<b>30</b>
Mura MPX-4/4 and MPX-4/2.....	31
Connection overview.....	31
Description of cables .....	32
Description of supported connections .....	32
Mura MPX-SDI.....	33
Connection overview.....	33
Description of cables .....	33
Description of supported connections .....	34
Mura MPX-4/0.....	35
Connection overview.....	35
Description of cables .....	36
Description of supported connections .....	36

Mura MPX-V16 and MPX-V8 .....	37
Connection overview.....	37
Description of cable.....	38
Description of supported connections .....	38
<b>Validating the network discovery of your Mura IPX Series cards .....</b>	<b>39</b>
Multiple subnet support.....	39
<b>Installing your software .....</b>	<b>40</b>
Obtaining a driver and additional software .....	40
Before you install .....	40
Installing your driver .....	40
Windows.....	40
Linux.....	40
Installing your APIs .....	40
Updating your Mura IPX Series display card.....	41
Additional software.....	41
More information .....	41
<b>Running the Mura IPX Series Updater.....</b>	<b>42</b>
Before you begin .....	42
Obtaining the Matrox Mura IPX 4K IP Decode and Display package .....	42
Updating your Mura IPX Series 4K Decode and Display devices.....	43
<b>Configuring your display wall layout.....</b>	<b>45</b>
Using the Network API to manage your layout .....	45
Using PowerDesk to set up your multi-display layout.....	45
Mura MPX Series.....	45
<b>Troubleshooting .....</b>	<b>46</b>
What to do if you have a problem.....	46
Common problems and solutions .....	46
<b>Product information.....</b>	<b>49</b>
Specifications .....	49
Mura IPX Series 12G-SDI Capture and IP Encode/Decode cards.....	49
Mura IPX Series 4K Decode and Display card.....	50
Mura IPX Series 4K DisplayPort Capture and IP Encode/Decode cards.....	51
Mura IPX Series 4K DisplayPort Capture and IP Decode cards .....	52
Mura IPX Series 4K HDMI Capture and IP Encode/Decode cards.....	53
Mura IPX Series 4K HDMI Capture and IP Decode cards.....	54

Mura MPX-4/0, MPX-4/2, MPX-4/4, MPX-SDI .....	55
Mura MPX-V8, MPX-V16 .....	56
Environmental .....	56
Mean Time Before Failure (MTBF) .....	57
Notes .....	57
<b>Appendix A – Matrox product overview .....</b>	<b>58</b>
Supported product combinations .....	58
Supported output types .....	59
Supported input types .....	59
Supported product capabilities .....	61
Software Development Kits (SDKs) .....	61
Matrox MuraControl software .....	62
Obtaining MuraControl software .....	62
More information .....	62
<b>Appendix B – Firewall requirements .....</b>	<b>63</b>
Network API and MuraControl .....	63
Display wall system .....	63
Matrox IPX Updater .....	64
Accessing your Windows Firewall settings .....	64
<b>Appendix C – Matrox secure cable solution .....</b>	<b>65</b>
Mini HDMI® – MURAI PXI-E4JF, MURAI PXI-E4JHF, MURAI PXI-D4JF, MURAI PXI-D4JHF .....	65
Mini DisplayPort™ – MURAI PXO-D4LF • MURAI PXO-D4LHF .....	67
<b>Customer support .....</b>	<b>68</b>
Matrox web .....	68
Technical support .....	68
Information we need .....	68
Program specific problems .....	69
Software package download .....	69
View your warranty information .....	69
View the third party software notices .....	69
Register your Matrox product .....	69

---

# Matrox safety information



To ensure safe and reliable operation of your Matrox product, to avoid personal injury, and to prevent damage to your computer or Matrox hardware, read the following guidelines.

---

## Installation and operation

- Read and retain all instructions. Only use your Matrox product according to the instructions, operating ranges, and guidelines provided in the Matrox user guide and other related Matrox documentation. Failure to follow these instructions could result in damage to your product or injury to the user or installer.
- Don't expose your Matrox product to rain, water, condensation, or moisture.
- Your Matrox product (card or unit) can become hot while operating. Always turn off your computer, unplug it, then wait for it to cool before touching any of the internal parts of your computer or installing your Matrox card. Allow hot surfaces to cool before touching your Matrox unit. 
- Static electricity can severely damage electronic parts. Before touching any electronic parts, drain static electricity from your body (for example, by touching the metal frame of your computer).
- When handling a card, carefully hold it by its edges and avoid touching its circuitry.
- Don't stack devices or place devices so close together that they're subject to recirculated or preheated air.
- Don't operate your system or Matrox product near a heat source or restrict airflow to your system, and make sure the ambient temperature doesn't exceed the maximum recommended temperatures. Don't block ventilation holes on your unit or system.

---

## If a power supply (internal or external) was included with your product

- Don't place the external power supply directly on top of the device.
- Only use power supplies originally supplied with the product or use a replacement that's approved by Matrox. Don't use the power supply if it appears to be defective or has a damaged chassis.

- Don't defeat the safety purpose of the polarized or grounding-type plug. A polarized plug has two blades with one wider than the other. A grounding-type plug has two blades and a third grounding prong. The wide blade or the third prong are provided for your safety. If the provided plug doesn't fit into your outlet, consult an electrician to replace the obsolete outlet.
- Make sure that nothing rests on the power cables and that the cables aren't located where they can be stepped on, pinched, or tripped over.
- Don't use damaged power cables.
- Unplug your system or device during lightning storms or if unused for long periods of time.

---

## If your product includes laser-based technology

- The device contains a Class 1 laser product for use only under the recommended operating conditions and guidelines. For more information, see your Matrox user guide.
- Invisible laser radiation may be emitted from disconnected fibers or connectors. Don't stare into beams or view directly with optical instruments.
- Only use optical transceivers originally supplied with the product or use a replacement that's approved by Matrox.
- For more information on laser support and compliance, see your Matrox user guide.

---

## If your product includes a battery

- The battery is non replaceable.
- To dispose of your product, see [www.matrox.com/environment/weee](http://www.matrox.com/environment/weee).



---

## Repair

- Don't attempt to open or repair a power supply unit (if one was supplied).
- Don't attempt to open or repair your Matrox product.
- If there's a fault with your Matrox product, review your Matrox warranty for more information.

---

# Before you begin

To avoid personal injury and to prevent damage to your system or Matrox hardware, read the following guidelines before installing your Matrox hardware.

---

## Using a validated platform

- For detailed information on how to install your Matrox Mura card in a validated systems, see the Matrox System Builder's Guide ([www.matrox.com/mura/support](http://www.matrox.com/mura/support)).
- For information on validated systems, motherboards, and chassis models, contact your Matrox representative or see the Matrox web site ([www.matrox.com/graphics](http://www.matrox.com/graphics)).

---

## Preventing damage to your hardware

### When installing your hardware

- Always turn off your system, unplug it, then wait for it to cool before touching any of the internal parts of your system or installing your Matrox product.
- While your system is turned off but still plugged in, some electrical current is supplied to the motherboard. This current may prevent newly installed hardware from working properly.
- Static electricity can severely damage electronic parts. Before touching any electronic parts, drain static electricity from your body (for example, by touching the metal frame of your system).
- When handling a card, carefully hold it by its edges and avoid touching its circuitry.
- Always try to insert or remove your card as straight as possible.

### When connecting your hardware

- Whenever you change your connection setup, make sure you're using the correct connectors and that all connectors are properly fastened.
- Don't change connections while your system is turned on. Before changing connections, make sure your system is shut down and turned off.
- Whenever you restart your system, make sure your monitors are already turned on. Otherwise, the software may not be able to properly detect your monitors.
- When connecting devices, make sure the connectors are properly fastened.



---

# Getting started

Thank you for purchasing a Matrox Display Wall product. You can use Matrox Mura IPX Series and Mura MPX Series cards as standalone solutions, combined with each other, with other Matrox products, or with third-party\* hardware to extend the capabilities of your Matrox-based display wall controller.

---

## Hardware supplied†

### Mura IPX Series –

- Mura IPX 12G-SDI Capture and IP Encode/Decode (MURAIPXI-E4SF • MURAIPXI-E4SHF) – Mura IPX Series card, 2 ribbon cables‡ (for framelock).
- Mura IPX 4K IP Decode and Display (MURAIPXO-D4LF • MURAIPXO-D4LHF) – Mura IPX Series card, 2 ribbon cables‡ (for framelock).
- Mura IPX 4K DisplayPort Capture and IP Decode (MURAIPXI-D2MF • MURAIPXI-D2MHF) – Mura IPX Series card, 2 ribbon cables‡ (for framelock).
- Mura IPX 4K HDMI Capture and IP Encode/Decode (MURAIPXI-E4JF • MURAIPXI-E4JHF) – Mura IPX Series card, 2 ribbon cables‡ (for framelock).
- Mura IPX 4K HDMI Capture and IP Decode (MURAIPXI-D4JF • MURAIPXI-D4JHF) – Mura IPX Series card, 2 ribbon cables‡ (for framelock).
- Mura IPX 4K DisplayPort Capture and IP Encode/Decode (MURAIPXI-E2MF • MURAIPXI-E2MHF) – Mura IPX Series card, 2 ribbon cables‡ (for framelock).

### Mura MPX Series –

- Mura MPX-4/4 – Mura MPX Series card, 2 KX20 to quad-DVI cables, 8 DVI to HD-15 adapters, 2 ribbon cables (for framelock), washer.
- Mura MPX-4/2 – Mura MPX Series card, 1 KX20 to quad-DVI cable, 1 KX20 to dual-DVI cable, 6 DVI to HD-15 adapters, 2 ribbon cables (for framelock), washer.
- Mura MPX-4/0 – Mura MPX Series card, 1 KX20 to quad-DVI cable, 4 DVI to HD-15 adapters, 2 ribbon cables (for framelock), washer.
- Mura MPX-SDI – Mura MPX Series card, 1 KX20 to dual-DVI cable, 2 DVI to HD-15 adapters, 2 DIN to BNC adapters, 2 ribbon cables (for framelock), washer.

---

\* For more information on supported third-party graphics cards, see the release notes. For information on how to configure your system, see “Matrox System Builder’s Guide.”

† The hardware supplied with your Matrox product may vary depending on the SKU or part number of your product. For more information, contact your Matrox representative.

‡ Matrox Mura IPX Series – The ribbon cables (for framelock) are currently unsupported.

- Mura MPX-V16 – Mura MPX Series card, 2 DVI to BNC adapters, 1 ribbon cable (for framelock), washer.
- Mura MPX-V8 – Mura MPX Series card, 1 DVI to BNC adapter, 1 ribbon cable (for framelock), washer.

---

## Optional hardware (sold separately)

Depending on your connection setup, you may need additional hardware. For more information, see the “Connection setup” section for your Matrox product.

---

## Software supplied

- Windows® driver package – Matrox provides a 64-bit version of the driver to use your Matrox display wall products.
- Linux® package – Matrox supports various distributions for your Matrox display wall products. For more information, see the *Readme* file included with the Matrox package for Linux.
- SDKs and APIs – Matrox offers a range of software, API, and libraries to configure your display wall and to create your own custom interfaces and applications.

For more information on the software available for your Matrox product, see “Supported product capabilities”, page 61.

---

## More information

We provide additional information in help and *Readme* files. Be sure to check for any last-minute release notes included with your product. Also, check the Matrox web site ([www.matrox.com/graphics](http://www.matrox.com/graphics)) for the latest Matrox software, technical support, and product information.

---

# Setting up a display wall

The following outlines the steps for installing, connecting, and setting up your Matrox card.

---

## Components of a display wall setup

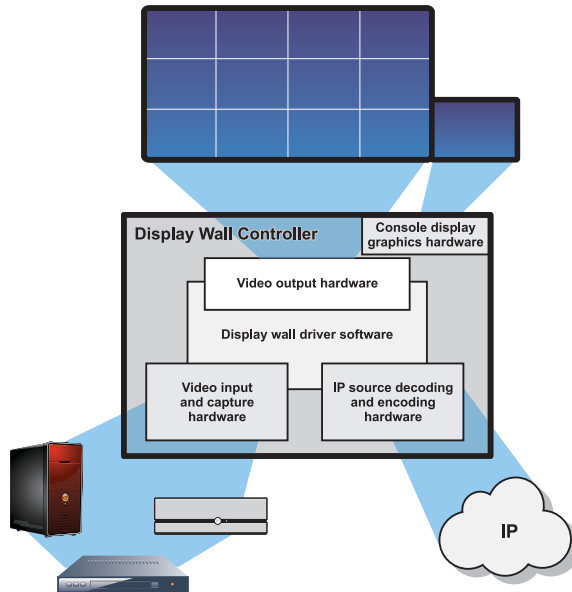

For more information on supported product combinations, input and output types, and operating system compatibility, see [“Appendix A – Matrox product overview”](#), page 58.

---

## Setup overview

### Mura IPX Series display card

- 1 Install your Matrox cards – see page 18.
- 2 Connect your cards – see page 25.
- 3 Update the software on your cards – see page 41.
- 4 Configure your display wall. You can use the following:
  - Matrox Network API – see page 45.

- MuraControl for Windows – [see page 62](#).

## **Mura IPX Series capture cards**

- 1** Install your Matrox cards – [see page 18](#).
- 2** Connect your cards – [see page 27](#).
- 3** Install your Matrox software – [see page 40](#).
- 4** Configure your display wall. You can use the following:
  - Matrox Network API – [see page 45](#).
  - Matrox PowerDesk – [see page 45](#).
  - MuraControl for Windows – [see page 62](#).

## **Using Matrox or third-party graphics hardware\* with Mura IPX Series capture cards**

- 1** Install your Matrox cards – [see page 18](#).
- 2** Connect your cards –
  - Graphics hardware – For more information, see the documentation for your graphics hardware.
  - Mura IPX Series capture cards – [see page 12](#).
- 3** Install the driver for your graphics hardware. For more information, see the documentation for your graphics hardware. For Matrox graphics hardware, skip this step as the Mura Display Wall Driver supports the Matrox graphics hardware compatible with your Mura IPX Series products.
- 4** Install the Matrox software for your Mura IPX Series capture cards – [see page 40](#).
- 5** Set up your multi-display layout. For more information, see the documentation for your graphics hardware.
- 6** Configure your display wall. You can use the following:
  - Matrox Network API – [see page 45](#).
  - MuraControl for Windows – [see page 62](#).

---

\* For more information on supported third-party graphics cards, see the release notes. For information on how to configure your system, see “Matrox System Builder’s Guide.”

## Mura IPX Series decode and display cards

- 1 Install your Matrox cards – [see page 18](#).
- 2 Connect your cards – [see page 25](#).
- 3 Run the Mura IPX Series Updater – [see page 42](#).
- 4 Set your output configuration and resolution. You can use the following:
  - Matrox Network API – [see page 45](#).
  - MuraControl for Windows – [see page 62](#).

## Mura MPX Series

- 1 Install your Matrox cards – [see page 18](#).
- 2 Connect your cards – [see page 30](#).
- 3 Install your Matrox software – [see page 40](#).
- 4 Configure your display wall. You can use the following:
  - Matrox Network API – [see page 45](#).
  - Matrox PowerDesk – [see page 45](#).
  - MuraControl for Windows – [see page 62](#).

---

# Planning your display wall

This section describes the steps to consider if you're setting up a Mura-based display wall for the first time. We recommend you review these steps *before* setting up your display wall.

---

## Planning the output layout of Mura MPX Series cards

### Setting your card order

Mura MPX-4/4, MPX-4/2, MPX-4/0, and MPX-SDI – The DIP switches on your Mura MPX Series output cards are used to control the order in which the GPUs of your cards are used. Setting the DIP switches is useful if you're setting up a large display wall layout that uses multiple cards. Ordering the output connectors enables PowerDesk software to properly lay out the outputs of your display wall and avoids you having to manually set up your multi-display layout.

For example, setting the first card to **0** means that card will be the first one used, and the first GPU of that card will be identified by PowerDesk as **A**.

To set the DIP switches on your cards, use the tip of a pen or pencil to flip the switch on or off. We recommend setting your card order as follows, starting with card **0**.\*

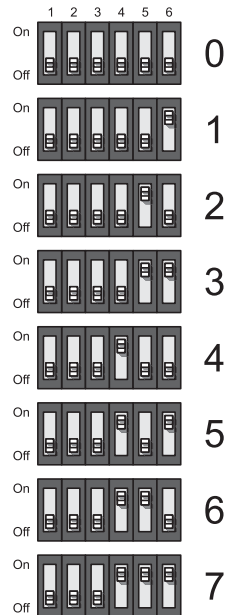

---

\* The DIP switches use binary counting to set the card order.

## Setting the order of your output connectors

Monitors are numbered consecutively based on which connector each is attached to. For example, on an Mura MPX Series output card using a quad-monitor cable, the monitor attached to the connector labeled **1** on the cable is identified as **1**, the monitor attached to the connector labeled **2** on the cable is identified as **2**, and so on.

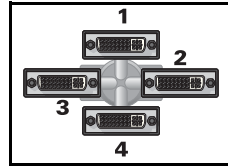

KX20 to quad-DVI cable

To facilitate the setup of your multi-display layout, we recommend connecting your monitors consecutively and arranging your monitors in pairs.

## Using PowerDesk to manage your multi-display layout

In a multi-card setup using Matrox Mura MPX Series cards, PowerDesk assigns letters to the GPU and numbers to the outputs associated with that GPU.



In the examples below, the order of the first card (4 outputs) is set as **0**, so its GPUs are identified as **A** and **B**. The four monitors connected to the first card are then identified as **A1**, **A2**, **B1**, and **B2**, which correspond to the monitors attached to connectors labeled respectively **1**, **2**, **3**, and **4** on your KX20 to quad-DVI cable.

## Using a multi-display layout with an even number of columns

This multi-display layout shows a 6 × 4 display wall. In this case, monitors are paired and follow each other sequentially from left to right (for example, **A1**, **A2**, **B1**, **B2**, **C1**, **C2**, and so on).

1	A1	A2	B1	B2	C1	C2
	D1	D2	E1	E2	F1	F2
	G1	G2	H1	H2	I1	I2
	J1	J2	K1	K2	L1	L2

## Using a multi-display layout with an uneven number of columns

This multi-display layout shows a 5 × 5 display wall. In this case, monitors are paired but don't follow each other sequentially from left to right. In this case, the GPUs associated with the last card (**K1, K2, L1, L2, M1**) are placed in the last column of the layout.

1	A1	A2	B1	B2	K1
	C1	C2	D1	D2	K2
	E1	E2	F1	F2	L1
	G1	G2	H1	H2	L2
	I1	I2	J1	J2	M1

Depending on your installation and connection, you may need to manually rearrange the outputs of your multi-display layout in PowerDesk to match the physical layout of your display wall.

For more information on setting up multiple displays, see [“Configuring your display wall layout”](#), page 45.

After planning your output layout, you're ready to install your cards (see [“Installing your Matrox cards”](#), page 18).

---

## Planning the input of Mura MPX Series and Mura IPX Series capture cards

Mura MPX Series\* and Mura IPX Series capture cards have input connectors. These input connectors are numbered according to the following guidelines:

- Cards are ordered in groups based on their order on the PCI bus. These groups are:
  - 1 Mura MPX-4/4, MPX-4/2, and MPX-SDI.  
You can specify the order of the cards in this group through DIP switches.
  - 2 Mura MPX-V16 and MPX-V8.
  - 3 Mura IPX Series capture cards.  
You can specify the order of the cards in this group through DIP switches.
- Inputs are then ordered according to the order of the connectors on the card.

---

\* Except Mura MPX-4/0.



## Setting the DIP switches

Mura MPX Series\* and Mura IPX Series capture cards – The DIP switches on your Mura MPX Series and Mura IPX Series capture cards are used to control the order of the cards in each group. Setting the DIP switches is useful if you're setting up a large display wall layout that uses multiple cards. Ordering the input connectors enables you to properly identify the inputs of your display wall.

For example, setting the first Mura MPX Series card to **0** means that the input connectors on that card will be the first one used and the first input connector will be labeled **Input 1**.

To set the DIP switches on your cards, use the tip of a pen or pencil to flip the switch on or off. We recommend setting your card order as follows, starting with card **0**.†

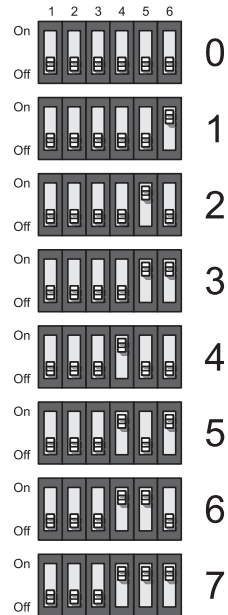

\* Except Mura MPX-4/0.

† The DIP switches use binary counting to set the card order.

# Installing your Matrox cards

This section describes how to install your Matrox card. If your Matrox card is already installed in your system, skip to the “Connection setup” section for the card you want to install. For information specific to your system, like how to remove its cover, see your system manual.

## Step-by-step installation

### 1 Open your system and remove your existing card

If a card *isn't* already installed, skip to [step 2](#).

- a** Using **Programs and Features** in the Windows **Control Panel**, remove any currently installed display drivers. Restart your system for the changes to take effect.

After your system restarts, you may be prompted to install drivers for the new graphics hardware detected. Click **Cancel**.

- b** Turn off your system and all peripherals such as your monitor or printer.
- c** Open the system and remove your existing card (if any).

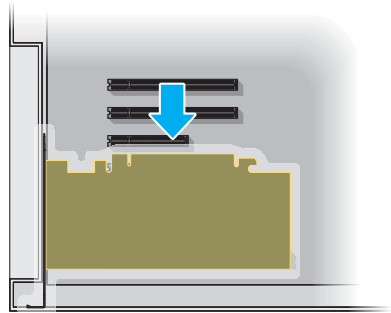

### 2 Choose an expansion slot

Most systems have different types of expansion slots. Choose a PCI Express® (PCIe®) slot depending on the type of card you have. Your system manual should identify the location of each type of expansion slot in your system.

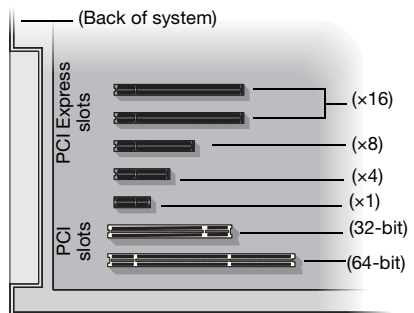



**Note:** If your system has multiple PCIe ×16 slots, your choice of PCIe slot may affect your card or system performance. Some PCIe ×16 slots support only 8 or 4 lanes. Make sure the PCIe slot you choose supports the proper number of lanes for your Mura card. For more information, see your computer manual or the Matrox System Builder’s Guide.

### 3 Insert your Matrox card

- a Position your Matrox card over the expansion slot you’ve chosen.
- b Push the card in firmly and evenly until it’s fully seated in the slot.
- c Secure the bracket of your Matrox card to the frame of your system.

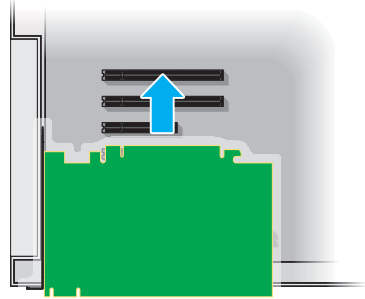

### 4 Secure the bracket of your Matrox card

**Mura MPX Series only** – To support the weight of your cable and to avoid damaging your Matrox card, you need to properly secure the bracket of your card to your system.

- a To secure your bracket, slip the washer provided with your Matrox product over the connectors, then screw the washer onto the bracket of your Matrox card.
- b Make sure the washer lies flat against the frame of your system.

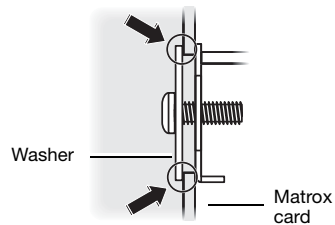
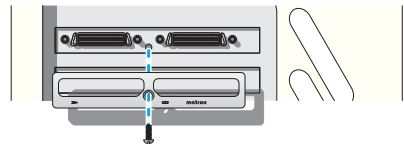

Your Matrox card is now installed. If you’re installing more than one card, see “[Installing multiple cards](#)”, page 20. **Before restarting your system**, connect your monitors or devices (see the “Connection setup” section for the card you want to connect). **After connecting**, restart your system and install your Matrox software.

---

## Installing multiple cards

Your chassis model may support the installation of multiple Matrox cards in your system. For information on validated platforms, contact your Matrox representative or see the Matrox web site ([www.matrox.com/graphics](http://www.matrox.com/graphics)).



**WARNING:** To avoid damaging your cards, always insert your card as straight as possible into the slot. Don't rock the card from side to side. If you meet resistance, don't force the card into the slot.

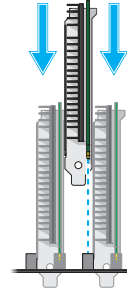

### Interconnecting multiple cards (FrameLock)

**Mura MPX Series** – Attach the ribbon cable to the connector labeled **Out** on one card to the connector labeled **In** on the next card.

Depending on the length needed, use either the long or short ribbon cable included with your product.

Repeat this for every card installed.

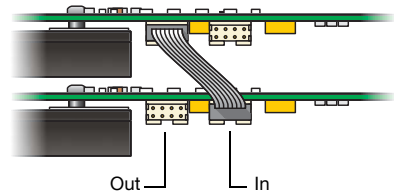

---

# Description of LED indicators

Your Matrox Mura cards have LED indicators that show you the configuration status of your setup and help you troubleshoot your cards.

---

## Mura IPX Series cards

Your Matrox Mura IPX Series cards have one LED indicator on their bracket.

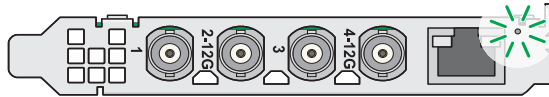

MURAIPXI-E4SF • MURAIPXI-E4SHF

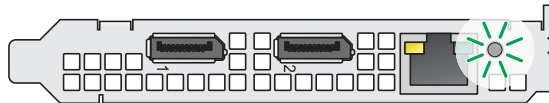

MURAIPXI-E2MF • MURAIPXI-E2MHF • MURAIPXI-D2MF • MURAIPXI-D2MHF

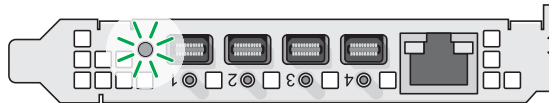

MURAIPXO-D4LF • MURAIPXO-D4LHF

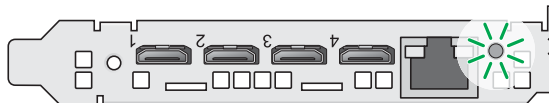

MURAIPXI-E4JF • MURAIPXI-E4JHF • MURAIPXI-D4JF • MURAIPXI-D4JHF

The following describes the behavior of this LED indicator.

LED Color	Behavior
Green (solid)	Card is active.
Green (slow blink)	Card is restarting.
Green (fast blink)	Factory reset in process.
Amber (solid)	Card is in maintenance mode.
Amber (slow blink)	Card is restarting and is in maintenance mode.
Amber (fast blink)	Card is updating the firmware.
Red (solid)	Card has detected a fatal error. Try restarting your system. If after restarting your system the LED indicator is still red, contact your vendor for technical support (see “Customer support”, page 68).
Red (slow blink)	Card has detected a misconnection. Try restarting your system. If after restarting your system the LED indicator is still red, contact your vendor for technical support (see “Customer support”, page 68).
Black (off)	No power. Make sure your card is properly installed. Also, make sure your system isn’t in power saving mode (see “Installing your Matrox cards”, page 18). For more information, contact your vendor (see “Customer support”, page 68).

## Network connector

The network connectors on your Mura IPX Series cards use LED indicators to provide information on the network activity and presence. The following describes the different network connector LEDs.

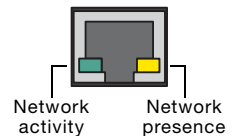

LED color	Network activity	Network presence
No LED (black)	No data transfer in progress or no network detected.	No communication established.
Green (fast blink)	Data transfer in progress.	—
Orange	—	Network communication established.

## Mura MPX-4/4, MPX-4/2, and MPX-4/0

Your Matrox Mura MPX Series cards have four LED indicators labeled (**Good, 12V, Fail, CFG\_Done**).

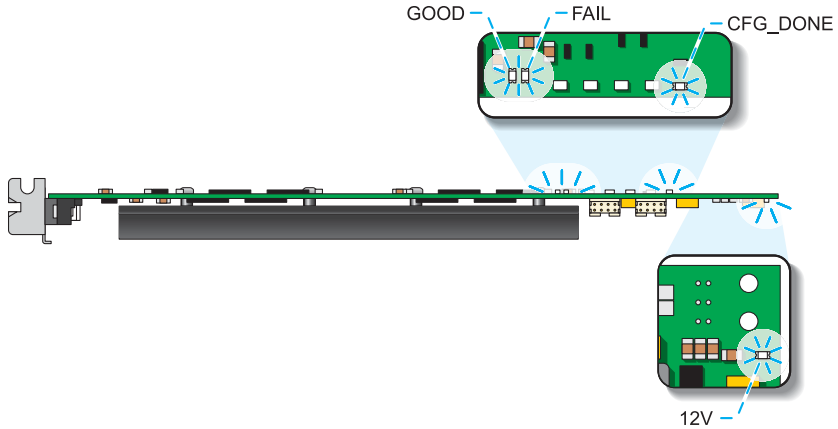

The following describes the behavior of these LED indicators.

LED	Color	Behavior
Good	Green	Card is active.
12V	Green	Card is properly powered.
Fail	Red	Card may have insufficient power. Try restarting your system. If after restarting your system the LED indicator is still red, contact your vendor for technical support (see “Customer support”, page 68).
CFG_Done	Black (off)	Problem occurred while programming your card. For more information, contact your vendor (see “Customer support”, page 68).

## Mura MPX-V16 and MPX-V8

Your Matrox Mura MPX-V16 card has three LED indicators labeled (**Power Good, FP1 Done, FP2 Done**) and your Mura MPX-V8 card has two LED indicators labeled (**Power Good, FP2 Done**).

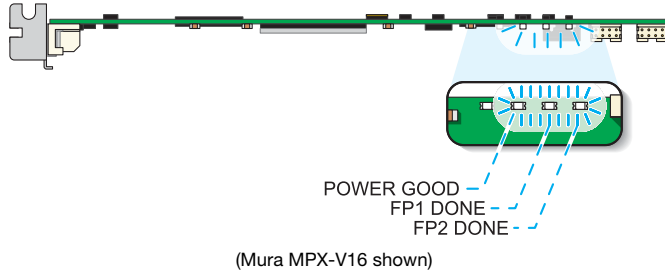

The following describes the behavior of these LED indicators.

LED	Color	Behavior
Power Good	Green	Card is properly powered.
FP1 Done or FP2 Done	Green	Card is active.
FP1 Done or FP2 Done	Black (off)	Problem occurred while programming your card. For more information, contact your vendor (see “Customer support”, page 68).

## Mura MPX-SDI

Your Matrox Mura MPX-SDI card has one LED indicator labeled (**CFG\_Done**).

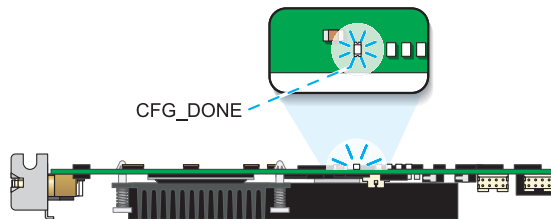

The following describes the behavior of these LED indicators.

LED	Color	Behavior
CFG_Done	Green	Card is active.
CFG_Done	Black (off)	Problem occurred while programming your card. For more information, contact your vendor (see “Customer support”, page 68).



# Connecting your Mura IPX Series display card

This section describes how to connect your Mura IPX Series 4K IP Decode and Display card.

- Note:** To make sure your cables are securely attached to your Matrox cards, use a cable retention bracket. To purchase a cable retention bracket, contact your Matrox representative. For more information, see [“Appendix C – Matrox secure cable solution”](#), page 65.

## MURAI PXO-D4LF and MURAI PXO-D4LHF

- Note:** Audio output is supported only on the DisplayPort connector labeled **1** of your Mura IPX Series display card.

### Connection overview

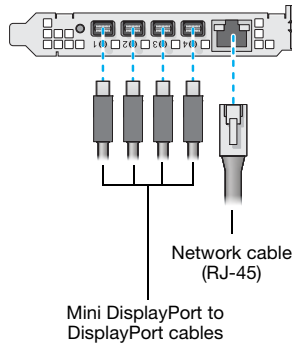

### Description of supported connections

Device connector	Description
<b>DisplayPort</b>	If your monitor has a DisplayPort connector, attach your mini DisplayPort to DisplayPort cable to your Matrox card. Connect the other end of the cable to your monitor.
<b>DVI</b>	If your monitor has a DVI connector, use a mini DisplayPort to DVI adapter (active) to connect to the mini DisplayPort connector on your Matrox card. Connect your monitor to the DVI connector on your adapter.

Device connector	Description
<b>HDMI</b>	If your monitor has an HDMI connector, use a mini DisplayPort to HDMI adapter (active*) to connect to the mini DisplayPort connector on your Matrox card. Connect your monitor to the HDMI connector on your adapter.
<b>Network (RJ-45)</b>	If your video device streams to an IP network, connect a network cable to your Matrox card. Your video device must stream using an RTSP, RTP, SRT, or MPEG-2 TS protocol.

\* Only active adapters (sold separately) are supported. Passive adapters aren't supported.

Once all your cards are connected, restart your system and install your Matrox software (see [“Installing your software”, page 40](#)).

# Connecting your Mura IPX Series capture card

This section describes how to connect your Mura IPX Series 4K Capture and IP Encode/Decode and your Mura IPX Series 4K Capture and IP Decode card.

Once all your cards are connected, restart your system and install your Matrox software (see “Installing your software”, page 43).



**Note:** To make sure your cables are securely attached to your Matrox cards, use a cable retention bracket. To purchase a cable retention bracket, contact your Matrox representative. For more information, see “Appendix C – Matrox secure cable solution”, page 63.

## MURAIPIXI-E4SF and MURAIPIXI-E4SHF

### Connection overview

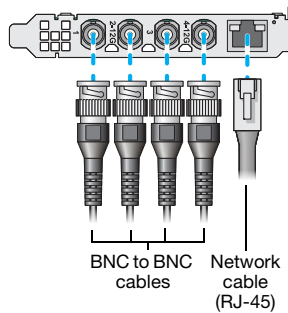

### Description of supported connections

Device connector	Description
<b>BNC</b>	If your video device has a BNC connector, attach your BNC cable to your Matrox card. Connect the other end of the cable to your video device.
<b>Network (RJ-45)</b>	If your video device streams to an IP network, connect a network cable to your Matrox card. Your video device must stream using an RTSP, RTP, SRT, or MPEG-2 TS protocol.

# MURAIPXI-E2MF, MURAIPXI-E2MHF, MURAIPXI-D2MF, and MURAIPXI-D2MHF



**WARNING:** To avoid damaging the DisplayPort connector on your DisplayPort monitor cable or on your Matrox product, carefully remove the DisplayPort cable by pressing the latch on the top of the DisplayPort connector while removing the connector.

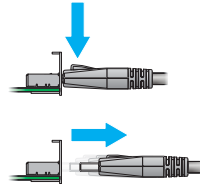

## Connection overview

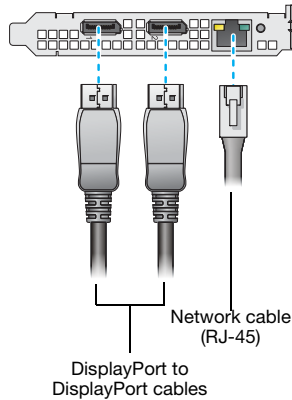

## Description of supported connections

Device connector	Description
<b>DisplayPort</b>	If your video device has a DisplayPort connector, attach your DisplayPort to DisplayPort cable to your Matrox card. Connect the other end of the cable to your video device.
<b>DVI</b>	If your video device has a DVI connector, use a DisplayPort to DVI adapter (active*) to connect to the mini DisplayPort connector on your Matrox card. Connect your video device to the DVI connector on your adapter.
<b>HDMI</b>	If your video device has an HDMI connector, use a DisplayPort to HDMI adapter (active*) to connect to the DisplayPort connector on your Matrox card. Connect your video device to the HDMI connector on your adapter.
<b>Network (RJ-45)</b>	If your video device streams to an IP network, connect a network cable to your Matrox card. Your video device must stream using an RTSP, RTP, SRT, or MPEG-2 TS protocol.

\* Only active adapters (sold separately) are supported. Passive adapters aren't supported.

# MURAIPXI-E4JF, MURAIPXI-E4JHF, MURAIPXI-D4JF, and MURAIPXI-D4JHF

## Connection overview

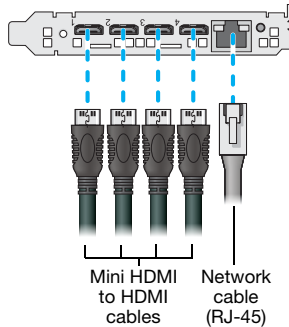

## Description of supported connections

Device connector	Description
<b>HDMI</b>	If your video device has an HDMI connector, attach your mini HDMI to HDMI cable to your Matrox card. Connect the other end of the cable to your video device.
<b>DVI</b>	If your video device has a DVI connector, use a mini HDMI to DVI adapter to connect to the mini HDMI connector on your Matrox card. Connect your video device to the DVI connector on your adapter.
<b>Network (RJ-45)</b>	If your video device streams to an IP network, connect a network cable to your Matrox card. Your video device must stream using an RTSP, RTP, SRT, or MPEG-2 TS protocol. <b>MURAIPXI-E4JF and MURAIPXI-E4JHF only</b> – You need to connect to the network to record to a Network Attached Storage (NAS) device or to stream video.



**Note:** To connect to the bracket of your Matrox product, the overmold (or boot) of the mini HDMI connectors must respect the maximum width (0.551in/14 mm) and thickness (0.331in/8.4 mm) stated in the HDMI specifications.



**Note:** Inputs from your Mura IPX Series capture cards are ordered according to the order of the cards on the PCI bus and then the order of the connectors on the card.

---

# Connecting your Mura MPX Series card

This section describes how to connect your Matrox Mura MPX Series card.

Once all your cards are connected, restart your system and install your Matrox software (see [“Installing your software”, page 40](#)).

## Mura MPX-4/4 and MPX-4/2

This section describes how to connect your output devices (monitors) and input devices to your Mura MPX-4/4, and MPX-4/2 cards.

### Connection overview

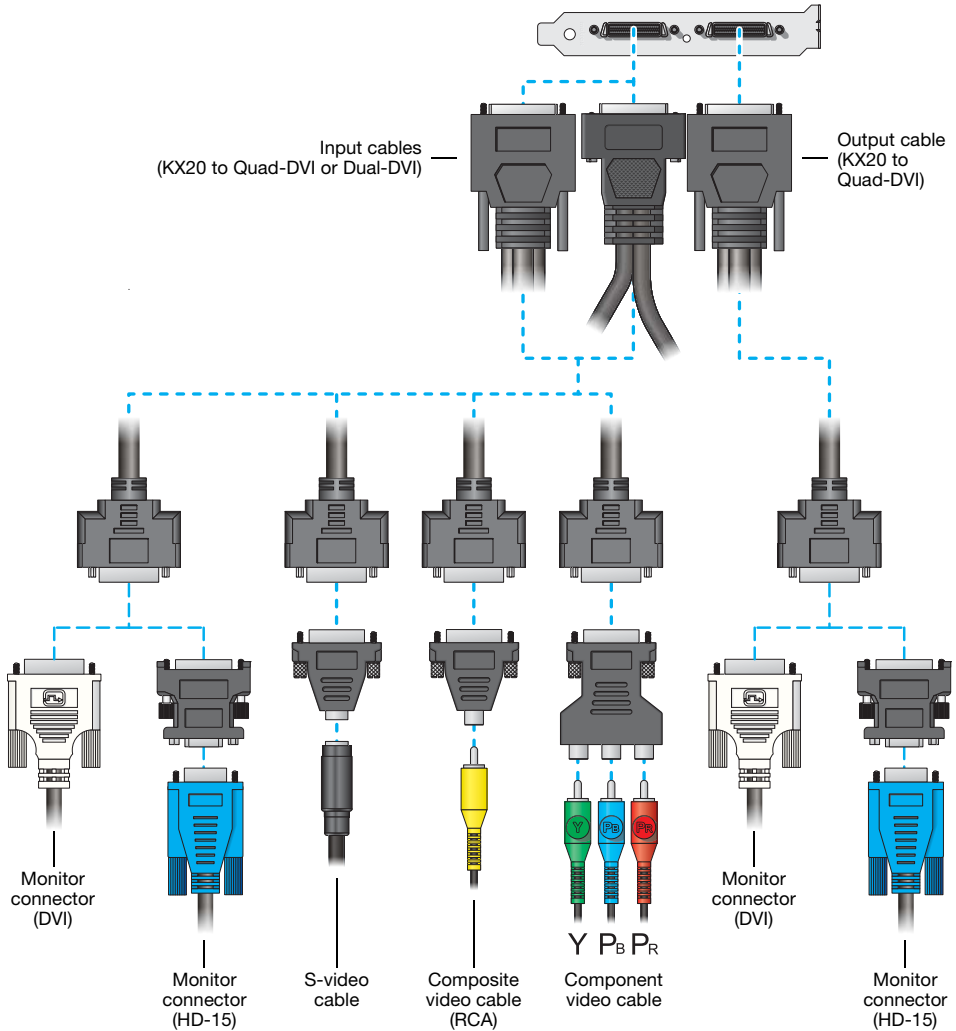

## Description of cables

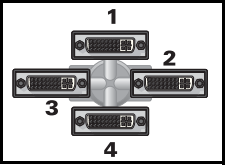
Cable	Description
<b>Output</b>	<p>Mura MPX-4/4 and MPX-4/2 cards use KX20 to quad-DVI cables to connect up to four (4) monitors per card.</p> <p>Monitors are numbered consecutively based on which connector each is attached to, starting with connector labeled 1.</p>
	 <p>KX20 to quad-DVI cable</p>
<b>Input</b>	<p>A Mura MPX-4/4 card uses a KX20 to quad-DVI cables to connect up to four (4) input devices per card. A Mura MPX-4/2 card uses a KX20 to dual-DVI cable to connect its input devices.</p>

## Description of supported connections

Device connector	Output	Input	Description
<b>DVI</b>	✓	✓	<p>If your monitor has a DVI connector, connect your monitor cable directly to a DVI connector on your output cable.</p> <p>If you connect a graphics card with a DVI monitor cable, connect your monitor cable directly to your input cable.</p>
<b>HD-15</b>	✓	✓	<p>If your monitor has an HD-15 connector, use a DVI to HD-15 adapter included with your Mura product to connect your monitor cable to your output cable.</p> <p>If you connect a graphics card with an HD-15 monitor cable, use a DVI to HD15 adapter included with your Mura product to connect your monitor cable to your input cable.</p>
<b>S-video</b>		✓	<p>If your video device has an S-video connector, use a DVI to S-video adapter to connect to the DVI connector on your input cable. Connect your video device to the S-video connector on your adapter.</p>
<b>Composite</b>		✓	<p>If your video device has a composite connector, use a DVI to Composite (RCA) adapter to connect to the DVI connector on your input cable. Connect your video device to the composite connector on your adapter.</p>
<b>Component</b>		✓	<p>If your video device has a component connector, use a DVI to Component adapter to connect to the DVI connector on your input cable. Connect your video device to the component connector on your adapter.</p>



## Mura MPX-SDI

This section describes how to connect your output devices (monitors) and input devices to your Mura MPX-SDI card.

### Connection overview

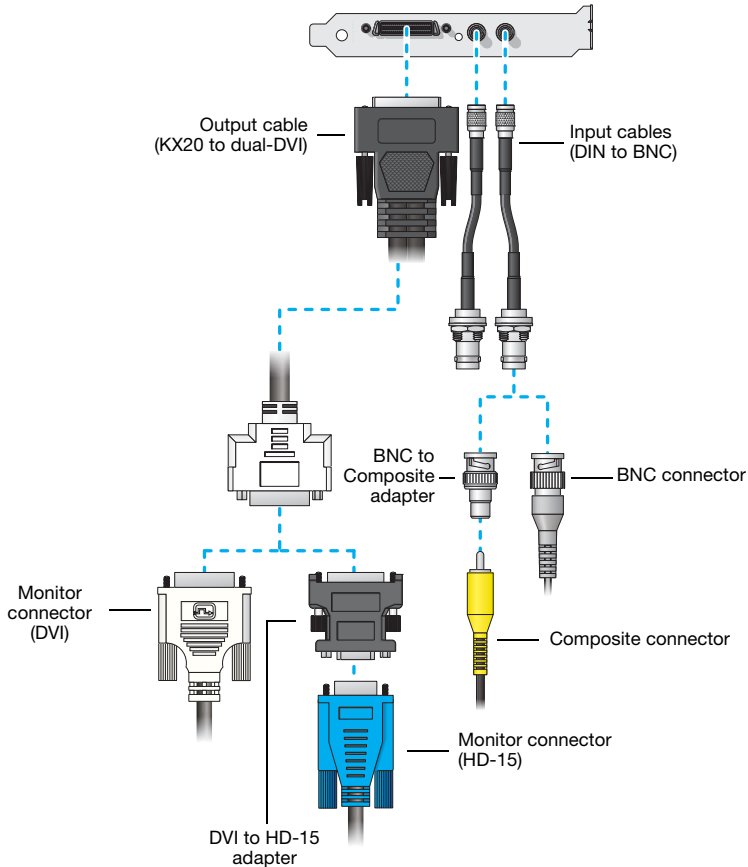

### Description of cables

Cable	Description
<b>Output</b>	Mura MPX-SDI cards use a KX20 to dual-DVI cable to connect up to two (2) monitors per card.
<b>Input</b>	Mura MPX-SDI cards use a DIN to BNC cable to connect up to two (2) input devices per card.



**WARNING:** To avoid damaging the DIN connector (1.0/2.3) on your DIN to BNC adapter or on your card, firmly hold the adapter, pull back the metal ring around the DIN connector on the cable, then carefully remove the DIN to BNC adapter.

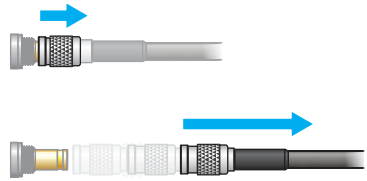

## Description of supported connections

Connection	Output	Input	Description
<b>DVI</b>	✓		If your monitor has a DVI connector, connect your monitor cable directly to a DVI connector on your output cable.
<b>HD-15</b>	✓		If your monitor has an HD-15 connector, use a DVI to HD-15 adapter included with your Mura product to connect your monitor cable to your output cable.
<b>Composite (RCA)</b>		✓	If your video device has an RCA composite connector, use a BNC to Composite (RCA) adapter to connect to the BNC connector on your input cable. Connect your video device to the composite connector on your adapter.
<b>Composite (BNC)</b>		✓	If your video device has a BNC composite connector, connect the composite cable directly to the BNC connector on your input cable.

## Mura MPX-4/0

This section describes how to connect your output devices (monitors) to your Mura MPX-4/0 card.

### Connection overview

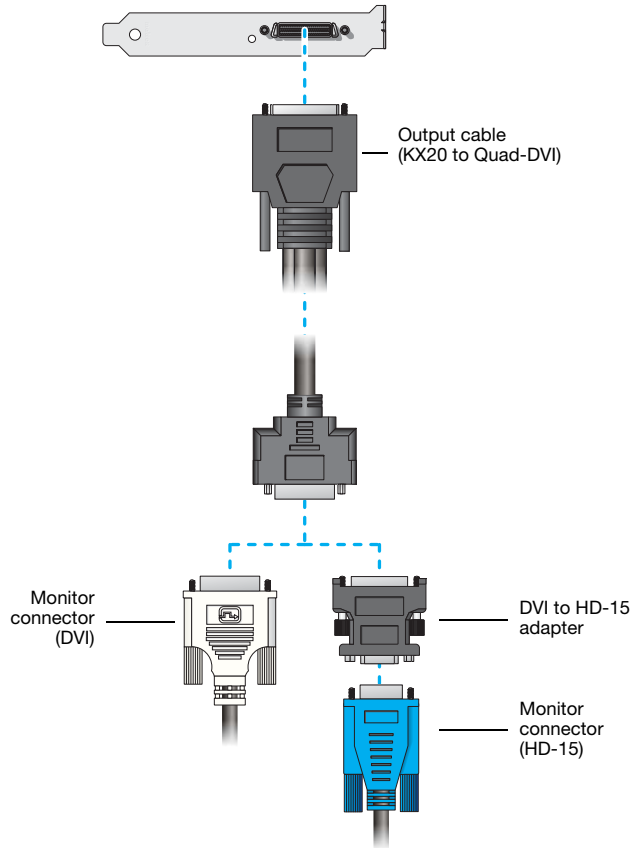

## Description of cables

Cable	Description
<b>Output</b>	<p>Mura MPX-4/0 cards use KX20 to quad-DVI cables to connect up to four (4) monitors per card.</p> <p>Monitors are numbered consecutively based on which connector each is attached to, starting with connector labeled 1.</p> <div data-bbox="879 201 1106 363" style="text-align: center;"> <p>The diagram shows a central KX20 connector with four DVI connectors extending from it. The connectors are labeled 1 (top), 2 (right), 3 (left), and 4 (bottom).</p> </div> <p style="text-align: center;">KX20 to quad-DVI cable</p>

## Description of supported connections

Device connector	Description
<b>DVI</b>	<p>If your monitor has a DVI connector, connect your monitor cable directly to a DVI connector on your output cable.</p>
<b>HD-15</b>	<p>If your monitor has an HD-15 connector, use a DVI to HD-15 adapter included with your Mura product to connect your monitor cable to your output cable.</p>

# Mura MPX-V16 and MPX-V8

This section describes how to connect your input devices to your Mura MPX-V16 or MPX-V8 card.

## Connection overview

Mura MPX-V16 bracket shown

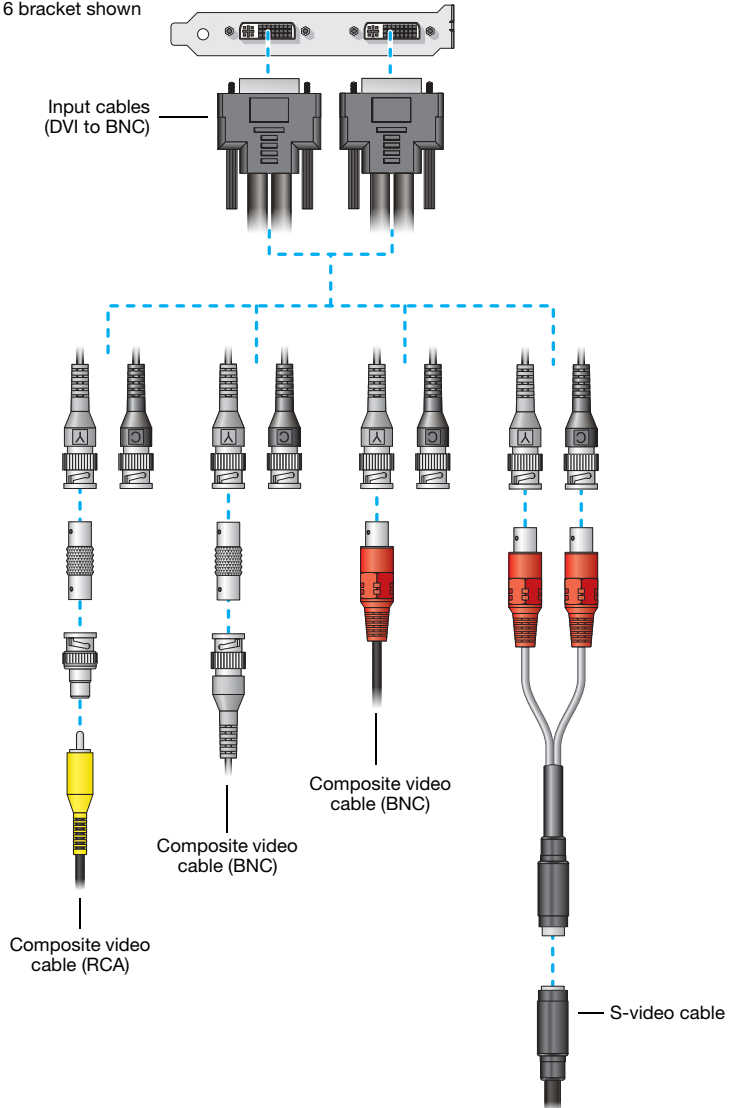

## Description of cable

Cable	Description
Input	Mura MPX-V16 or MPX-V8 cards use DVI to BNC cables to connect to input devices.

## Description of supported connections

Connector	Description
Composite (RCA)	If your video device has an RCA composite connector, use a BNC to Composite (RCA) adapter to connect to the <b>Y</b> connector on your input cable. Connect your video device to the composite connector on your adapter.
Composite (BNC)	If your video device has a BNC composite connector, connect the composite cable directly to the <b>Y</b> connector on your input cable.
S-video	If your video device has an S-video connector, use a BNC to S-video adapter to connect to the <b>Y</b> and <b>C</b> connectors on your input cable. Connect your video device to the S-video connector on your adapter.

---

# Validating the network discovery of your Mura IPX Series cards

Matrox Mura IPX Series cards are initially assigned their IP addresses through DHCP (Dynamic Host Control Protocol). After connecting your devices, we recommend verifying that all your devices are discovered by the network.

Under the **Network** section in the Windows **File Explorer**, make sure the Mura IPX Series cards and IP source devices connected to the network are listed.

If prompted to enable network discovery and file sharing on your network when validating network discovery, enable these two features by clicking the prompt at the top of your Windows Explorer window. These two features must be enabled for Windows to detect the Mura IPX Series cards on your subnet.

---

## Multiple subnet support

Mura IPX Series in the same subnet can be detected through the UPnP (Universal Plug and Play) protocol. If you have cards in different subnets of your network, you need to validate network discovery in each subnet separately.

---

# Installing your software

This section describes how to install your Matrox driver and software.

---

## Obtaining a driver and additional software

- If your Matrox product was provided by the manufacturer of your system, check the web site of that manufacturer for the latest driver. A driver provided by the manufacturer of your system is more likely to be tested with your system model.
- Matrox makes the latest drivers, software, and utilities available on the Matrox Mura product page ([www.matrox.com/graphics/en/support/drivers/download/mura](http://www.matrox.com/graphics/en/support/drivers/download/mura)).
- For additional SDKs and APIs, contact your Matrox representative.

---

## Before you install

- You may need administrator rights to install or uninstall certain software, or to change certain settings. For more information, see Windows documentation.
- To avoid potential problems, we recommend you install the latest Service Pack and hot fixes for your version of Windows.

---

## Installing your driver

### Windows

Download and run the Matrox driver package, then follow the on-screen instructions.

### Linux

Download and run the Matrox driver package for Linux, then follow the on-screen instructions. For more information on the supported Linux distributions, see the *Readme* file included with your package for Linux.

---

## Installing your APIs

Run the *MSI* from your Matrox API package. For more information, see the documentation included with your Matrox API.



---

## Updating your Mura IPX Series display card

Download the Mura IPX Updater software package. Run the appropriate updater and follow the on-screen instructions. The Matrox Network API is automatically installed. You can use the Matrox Network API or MuraControl for Windows to configure your Mura IPX Series display card.

---

## Additional software

- Matrox MuraControl – [see page 62](#).

---

## More information

We provide additional information in help and *Readme* files. Be sure to check for any last-minute release notes included with your product. Also, check the Matrox web site ([www.matrox.com/graphics](http://www.matrox.com/graphics)) for the latest Matrox software, technical support, and product information.

---

# Running the Mura IPX Series Updater

MURAIPXO-D4LF and MURAIPXO-D4LHF only – The Matrox IPX Series Updater enables you to update the software on your Matrox Mura IPX 4K IP Decode and Display products.



**Note:** Your Mura IPX 4K IP Decode and Display card may ship with older software versions. Before using your Mura IPX 4K IP Decode and Display card, you must update the software installed on your devices to use the version of your deployed release.

---

## Before you begin

Before you update your Mura IPX 4K IP Decode and Display devices, read the following guidelines:

- Make sure you have at least 1 GB of free disk space available.
- **Windows only** – Make sure Microsoft .NET Framework version 4.5 is installed on your system.
- **Linux only** – Make sure Xamarin “mono-complete” package version 5.4.0.201 or later is installed on your system.
- To avoid possible problems with your Mura IPX 4K IP Decode and Display devices, we recommend running only one instance of the Mura IPX Series Updater at a time.
- Make sure you’re running the latest version of the Mura IPX Series Updater.
- Close any programs that may be running and using any of the Matrox display wall APIs.
- Close any display wall layout.

---

## Obtaining the Matrox Mura IPX 4K IP Decode and Display package

Matrox makes the latest updater and software package for your Mura IPX 4K IP Decode and Display products available on the Matrox web site

([www.matrox.com/graphics/en/support/drivers/download/mura](http://www.matrox.com/graphics/en/support/drivers/download/mura)).

# Updating your Mura IPX Series 4K Decode and Display devices

On a system on the same subnet as your Mura IPX Series device:

- 1 Download the latest software package and extract the files to a local folder on your system (for example, *C:\Updater*).
- 2 Browse to the folder containing the extracted files.
- 3 **Windows** – Run the *UpdaterOverNetwork.exe* file.  
**Linux** – Enter the command *mono UpdaterOverNetwork.exe*.

This opens the Matrox Mura IPX Series Updater.

- 4 Scan for available Mura IPX Series devices or locate your Mura IPX Series device using its IP address.

To scan for Mura IPX Series devices on your subnet, select **Automatic detection**, and then click **Search**.

To locate one or more Mura IPX Series devices using their IP address, select **Manual detection** and enter the IP

address of each Mura IPX Series device you want to locate. Separate each IP address with a space.

You can also click the browse icon () , enter one IP address per line, then click **Apply** once all addresses are entered. When you're done, click **Search**.

Clicking **Search** again adds newly located devices to the list.

- 5 Select the devices you want to update. Devices with an older firmware version are automatically selected.

To change the sort order of the device tiles, right-click the device list box, select **Sort by** and the sorting order to use. To deselect all items, right-click the device list box and select **Unselect all devices**.

- 6 To reset device settings, including the IP address, while updating the software, enable Reset configuration.
- 7 When you're done adding Mura IPX Series devices to the list of devices you want to update, click **Update**.

Updating devices may take up to 5 minutes. For more information on the process of a firmware update, click **Show log** at the bottom of the program window.

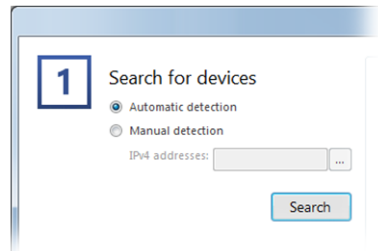

If you're updating a Mura IPX Series and the updater is suddenly interrupted (for example, in the event of a network or power interruption), your Mura IPX Series may not be fully updated and will continue to run in maintenance mode. To recover and resume the update, re-launch the updater.

---

# Configuring your display wall layout

---

## Using the Network API to manage your layout

Use the Matrox Network API to set up your outputs and configure the advanced features of your display wall layout.

For more information, see the documentation included with the Network API.

---

## Using PowerDesk to set up your multi-display layout



Setting up your multi-display layout using PowerDesk software involves entering the number of columns and rows for your display wall layout and adjusting the settings for your outputs (such as rotation, resolution, color palette, and refresh rate).

---

### Mura MPX Series

To set up a multi-display layout for your Mura MPX Series card:

- 1 Right-click your Windows desktop and select **Launch Matrox PowerDesk**. From the main interface of Matrox PowerDesk, click **Multi-Display Setup**.
- 2 Under **Basic configurations**, select **Use stretched mode**.
- 3 Enter the number of **Columns** and **Rows** for your multi-display setup, then click **OK**.
- 4 Preview your setup in the work area. If you're satisfied, click **OK** or **Apply** to apply your multi-display layout. Otherwise, click **Cancel**.

Depending on your installation and connection, you may need to manually rearrange the outputs of your multi-display layout in PowerDesk to match the physical layout of your display wall.

For more information on setting up multiple displays, see Matrox PowerDesk help.

---

# Troubleshooting

---

## What to do if you have a problem

If you experience problems with your Matrox product:

- Make sure your Matrox card is properly installed, you're using the correct connectors, and that all connectors are properly fastened.
- Make sure you have administrator rights on the system you want to use. For more information, see Windows documentation.
- Review the documentation provided with your Matrox product, including the information in this section and in your Matrox System Builder's Guide ([www.matrox.com/mura/support](http://www.matrox.com/mura/support)), to see if your problem is already addressed.

If your problem persists, contact Matrox. For more information, see “Customer support”, page 68.

---

## Common problems and solutions

This section addresses specific problems to your Matrox product that could prevent you from using your system or graphics hardware.

**Problem** **Not all graphics cards in the computer are fully supported**  
(Software doesn't work with a certain graphics card, or another graphics card doesn't work at all)

**Cause** If you have different models of graphics cards in your computer, your Matrox driver may not support all the graphics cards in your computer.

**Solution** Disable or remove any graphics hardware not supported by the driver you want to use. If there's graphics hardware built into the motherboard of your computer that's not supported by your software, see your system manual for information on how to disable this graphics hardware.

**Cause** **Windows 10/7** – If the Windows method for driver installation was used (instead of running the setup program included with your Matrox driver), the driver may not be installed for all the graphics cards it supports.

**Solution** Run the setup program included with the Matrox driver. The setup program automatically installs the driver for each Matrox graphics card it supports.

**Problem System performance is slow or degraded**

**Cause** Your system or cards may be overheating.

**Solution** Make sure the operating temperature of your graphics chip is within a normal range:

- 1 Access Matrox PowerDesk (see “Using PowerDesk to set up your multi-display layout”, page 45).
- 2 From the main interface, click **Help and Troubleshooting** → **Troubleshoot**.
- 3 Check the peak temperature being reported.

**Cause** You may be using a platform that hasn’t been validated by Matrox.

**Solution** Use a validated platform. For information on supported systems, motherboards, and chassis models, contact your Matrox representative or see the Matrox web site ([www.matrox.com/graphics](http://www.matrox.com/graphics)).

**Problem Mura IPX Series card not discovered on the network**

**Cause** Your Matrox product may not be properly connected or may be on a different subnet.

**Solution** Verify the connection and status LEDs on your Matrox product (see “Network connector”, page 22). Also, make sure your Matrox product is properly connected and that all connectors are properly fastened.

**Cause** Your Matrox product may be on an external network or on a different subnet.

**Solution** Make sure your Mura IPX Series card and the IP source are on the same subnet (see “Validating the network discovery of your Mura IPX Series cards”, page 39). For more information, contact your network administrator.

**Cause** Windows Server 2019/2016/2008 R2 only – The Windows SSDP Discovery service may be disabled on your system.

**Solution** Make sure the SSDP Discovery service is enabled on your system.

**Cause** Network discovery and file sharing may not be enabled on your system.

**Solution** Enable network discovery and file sharing on your system.

**Cause** The firewall for your display wall system or for your network may be enabled and may prevent communication with your Mura IPX Series cards.

**Solution** Make sure your firewall is properly configured to allow the necessary communication between your Mura IPX Series cards and the various networked components. For more information, see [“Appendix B – Firewall requirements”](#).



# Product information

## Specifications

### Mura IPX Series 12G-SDI Capture and IP Encode/Decode cards

	MURAIPIXI-E4SF • MURAIPIXI-E4SHF
<b>Card type</b>	PCIe x16 2.0 (x16 mechanical, x8 electrical)
<b>Form factor</b>	ATX
<b>Memory</b>	8 GB
<b>Connectors</b>	4x BNC, 1x 100/1000 Base-T RJ45 Ethernet Port
<b>Outputs supported</b>	—
<b>Inputs supported</b>	4 SDI + IP
<b>SDI input resolutions*</b>	12G-SDI, 3G-SDI, HD-SDI, SD-SDI
<b>IP stream support</b>	RTSP, RTP, SRT, MPEG-2 TS
<b>Video CODEC engine</b>	H.264
<b>Audio stream support</b>	✓†
<b>H.264 decode ‡§</b>	two 3840 × 2160 @ 60 Hz, four 3840 × 2160 @ 30 Hz, eight 1920 × 1080 @ 60 Hz, sixteen 1920 × 1080 @ 30 Hz, or numerous SD channels
<b>H.264 encode ‡§</b>	two 3840 × 2160 @ 60Hz, four 3840 × 2160 @ 30Hz, eight 1920 × 1080 @ 60Hz, sixteen 1920 × 1080 @ 30Hz, or numerous SD IP streams
<b>Maximum card dimensions</b>	L: 9.02 in / W: 0.75 in / H: 4.376 in L: 22.9 cm / W: 1.91 cm / H: 11.1 cm
<b>Regulatory compliance</b>	Class B: FCC, CE, RCM, VCCI, ICES-3, CSA, KC

\* 12G-SDI is supported only on connectors 2 and 4. 6G-SDI isn't supported. Not all 12G-SDI and 3G-SDI formats are supported. For more information, contact Matrox.

† Supported only with Matrox C-Series graphics cards.

‡ Standard resolutions listed above. Support for custom resolutions available. For specific requirements, contact your Matrox representative.

§ In YUV 4:2:0, 12 bits per pixel (8 bits per component).

## Mura IPX Series 4K Decode and Display card

	MURAIPXO-D4LF • MURAIPXO-D4LHF
<b>Card type</b>	PCIe x16 2.0 (power only)
<b>Form factor</b>	ATX
<b>Memory</b>	4 GB
<b>Connectors</b>	4x Mini DisplayPort, 1x 100/1000 Base-T RJ45 Ethernet Port
<b>Output formats supported*</b>	DisplayPort, DVI, HDMI
<b>Outputs supported</b>	4
<b>Inputs supported</b>	IP
<b>Maximum output resolutions</b>	4096 × 2160 @ 30 Hz, 3840 × 2160 @ 30 Hz, 2560 × 600 @ 60 Hz
<b>IP stream support</b>	RTSP, RTP, SRT, MPEG-2 TS
<b>Video CODEC engine</b>	H.264
<b>Audio stream support</b>	✓
<b>H.264 decode †</b>	two 3840 × 2160 @ 60 Hz, four 3840 × 2160 @ 30 Hz, eight 1920 × 1080 @ 60 Hz, sixteen 1920 × 1080 @ 30 Hz, or numerous SD channels
<b>Maximum card dimensions</b>	L: 9.02 in / W: 0.75 in / H: 4.376 in L: 22.9 cm / W: 1.91 cm / H: 11.1 cm
<b>Regulatory compliance</b>	Class B: FCC, CE, RCM, VCCI, ICES-3, CSA, KC

\* DVI and HDMI monitors are supported using identical third-party active adapters (sold separately).

† Standard resolutions listed above. Support for custom resolutions available. For specific requirements, contact your Matrox representative.

## Mura IPX Series 4K DisplayPort Capture and IP Encode/Decode cards

	MURAIPXI-E2MF • MURAIPXI-E2MHF
<b>Card type</b>	PCIe x16 2.0 (x16 mechanical, x8 electrical)
<b>Form factor</b>	ATX
<b>Memory</b>	8 GB
<b>Connectors</b>	2x DisplayPort 1.2, 1x 100/1000 Base-T RJ45 Ethernet Port
<b>Outputs supported</b>	—
<b>Inputs supported</b>	2x DisplayPort 1.2 + IP
<b>Maximum DisplayPort input resolutions</b>	4096 × 2160 @ 60 Hz, 4096 × 2160 @ 30 Hz, 3840 × 2160 @ 60 Hz, 3840 × 2160 @ 30 Hz
<b>IP stream support</b>	RTSP, RTP, SRT, MPEG-2 TS
<b>Video CODEC engine</b>	H.264
<b>Audio stream support</b>	✓*
<b>H.264 decode †‡</b>	two 3840 × 2160 @ 60 Hz, four 3840 × 2160 @ 30 Hz, eight 1920 × 1080 @ 60 Hz, sixteen 1920 × 1080 @ 30 Hz, or numerous SD channels
<b>H.264 encode *†‡</b>	two 3840 × 2160 @ 60Hz, four 3840 × 2160 @ 30Hz, eight 1920 × 1080 @ 60Hz, sixteen 1920 × 1080 @ 30Hz, or numerous SD IP streams
<b>Maximum card dimensions</b>	L: 9.02 in / W: 0.75 in / H: 4.376 in L: 22.9 cm / W: 1.91 cm / H: 11.1 cm
<b>Regulatory compliance</b>	Class B: FCC, CE, RCM, VCCI, ICES-3, CSA, KC

\* Supported only with Matrox C-Series graphics cards.

† Standard resolutions listed above. Support for custom resolutions available. For specific requirements, contact your Matrox representative.

‡ In YUV 4:2:0, 12 bits per pixel (8 bits per component).

## Mura IPX Series 4K DisplayPort Capture and IP Decode cards

	MURAIPXI-D2MF • MURAIPXI-D2MHF
<b>Card type</b>	PCIe x16 2.0 (x16 mechanical, x8 electrical)
<b>Form factor</b>	ATX
<b>Memory</b>	8 GB
<b>Connectors</b>	2x DisplayPort 1.2, 1x 100/1000 Base-T RJ45 Ethernet Port
<b>Outputs supported</b>	—
<b>Inputs supported</b>	2x DisplayPort 1.2 + IP
<b>Maximum DisplayPort input resolutions</b>	4096 × 2160 @ 60 Hz, 4096 × 2160 @ 30 Hz, 3840 × 2160 @ 60 Hz, 3840 × 2160 @ 30 Hz
<b>IP stream support</b>	RTSP, RTP, SRT, MPEG-2 TS
<b>Video CODEC engine</b>	H.264
<b>Audio stream support</b>	✓*
<b>H.264 decode †‡</b>	two 3840 × 2160 @ 60 Hz, four 3840 × 2160 @ 30 Hz, eight 1920 × 1080 @ 60 Hz, sixteen 1920 × 1080 @ 30 Hz, or numerous SD channels
<b>H.264 encode †‡</b>	—
<b>Maximum card dimensions</b>	L: 9.02 in / W: 0.75 in / H: 4.376 in L: 22.9 cm / W: 1.91 cm / H: 11.1 cm
<b>Regulatory compliance</b>	Class B: FCC, CE, RCM, VCCI, ICES-3, CSA, KC

\* Supported only with Matrox C-Series graphics cards.

† Standard resolutions listed above. Support for custom resolutions available. For specific requirements, contact your Matrox representative.

‡ In YUV 4:2:0, 12 bits per pixel (8 bits per component).

## Mura IPX Series 4K HDMI Capture and IP Encode/Decode cards

	MURAIPIXI-E4JF • MURAIPIXI-E4JHF
<b>Card type</b>	PCIe ×16 2.0 (×16 mechanical, ×8 electrical)
<b>Form factor</b>	ATX
<b>Memory</b>	8 GB
<b>Connectors</b>	4× Mini HDMI, 1× 100/1000 Base-T RJ45 Ethernet Port
<b>Outputs supported</b>	—
<b>Inputs supported</b>	4× HDMI + IP
<b>HDCP capture*</b>	✓
<b>Maximum HDMI input resolutions</b>	4096 × 2160 @ 60 Hz†, 4096 × 2160 @ 30 Hz, 3840 × 2160 @ 60 Hz†, 3840 × 2160 @ 30 Hz
<b>IP stream support</b>	RTSP, RTP, SRT, MPEG-2 TS
<b>Video CODEC engine</b>	H.264
<b>Audio stream support</b>	✓‡
<b>H.264 decode †§</b>	two 3840 × 2160 @ 60 Hz, four 3840 × 2160 @ 30 Hz, eight 1920 × 1080 @ 60 Hz, sixteen 1920 × 1080 @ 30 Hz, or numerous SD channels
<b>H.264 encode †‡§</b>	two 3840 × 2160 @ 60Hz, four 3840 × 2160 @ 30Hz, eight 1920 × 1080 @ 60Hz, sixteen 1920 × 1080 @ 30Hz, or numerous SD IP streams
<b>Maximum card dimensions</b>	L: 9.02 in / W: 0.75 in / H: 4.376 in L: 22.9 cm / W: 1.91 cm / H: 11.1 cm
<b>Regulatory compliance</b>	Class B: FCC, CE, RCM, VCCI, ICES-3, CSA, KC

\* Supported with driver version 3.01.01 or later with a controller using Mura MPX Series cards only. Certain limitations may apply. Matrox strongly recommends that you review the HDCP web site ([www.digital-cp.com](http://www.digital-cp.com)) and make sure you understand your legal obligations and responsibility.

† In YUV 4:2:0, 12 bits per pixel (8 bits per component).

‡ Supported only with Matrox C-Series graphics cards.

§ Standard resolutions listed above. Support for custom resolutions available. For specific requirements, contact your Matrox representative.

## Mura IPX Series 4K HDMI Capture and IP Decode cards

	MURAIPXI-D4JF • MURAIPXI-D4JHF
<b>Card type</b>	PCIe x16 2.0 (x16 mechanical, x8 electrical)
<b>Form factor</b>	ATX
<b>Memory</b>	8 GB
<b>Connectors</b>	4x Mini HDMI, 1x 100/1000 Base-T RJ45 Ethernet Port
<b>Outputs supported</b>	—
<b>Inputs supported</b>	4x HDMI + IP
<b>HDCP capture*</b>	✓
<b>Maximum HDMI input resolutions</b>	4096 × 2160 @ 60 Hz <sup>†</sup> , 4096 × 2160 @ 30 Hz, 3840 × 2160 @ 60 Hz <sup>†</sup> , 3840 × 2160 @ 30 Hz
<b>IP stream support</b>	RTSP, RTP, SRT, MPEG-2 TS
<b>Video CODEC engine</b>	H.264
<b>Audio stream support</b>	✓‡
<b>H.264 decode §†</b>	two 3840 × 2160 @ 60 Hz, four 3840 × 2160 @ 30 Hz, eight 1920 × 1080 @ 60 Hz, sixteen 1920 × 1080 @ 30 Hz, or numerous SD channels
<b>H.264 encode</b>	—
<b>Maximum card dimensions</b>	L: 9.02 in / W: 0.75 in / H: 4.376 in L: 22.9 cm / W: 1.91 cm / H: 11.1 cm
<b>Regulatory compliance</b>	Class B: FCC, CE, RCM, VCCI, ICES-3, CSA, KC

\* Supported with driver version 3.01.01 or later with a controller using Mura MPX Series cards only. Certain limitations may apply. Matrox strongly recommends that you review the HDCP web site ([www.digital-cp.com](http://www.digital-cp.com)) and make sure you understand your legal obligations and responsibility.

† In YUV 4:2:0, 12 bits per pixel (8 bits per component).

‡ Supported only with Matrox C-Series graphics cards.

§ Standard resolutions listed above. Support for custom resolutions available. For specific requirements, contact your Matrox representative.

## Mura MPX-4/0, MPX-4/2, MPX-4/4, MPX-SDI

	Mura MPX-4/0	Mura MPX-4/2	Mura MPX-4/4	Mura MPX-SDI
<b>Card type</b>	PCIe x16 2.0	PCIe x16 2.0	PCIe x16 2.0	PCIe x16 1.0
<b>Form factor</b>	ATX	ATX	ATX	ATX
<b>Memory</b>	2 GB	2 GB	2 GB	1 GB
<b>Output formats supported</b>	DVI, RGB/VGA	DVI, RGB/VGA	DVI, RGB/VGA	DVI, RGB/VGA
<b>Input formats supported</b>	—	DVI, RGB/VGA, Component, S-video, Composite	DVI, RGB/VGA, Component, S-video, Composite	SMPTE 259M, SMPTE 292M, SMPTE 296M, SMPTE 424M, SMPTE 425M
<b>HDCP capture*</b>	✓	✓	✓	—
<b>Connectors</b>	1x KX20	2x KX20	2x KX20	1x KX20, 2x DIN 1.0/2.3
<b>Outputs supported</b>	4	4	4	2
<b>Inputs supported</b>	0	2	4	2
<b>Maximum output resolutions</b>	2048 × 1152 (DVI), 2048 × 1536 (RGB/VGA)	2048 × 1152 (DVI), 2048 × 1536 (RGB/VGA)		1920 × 1080
<b>Maximum input resolutions</b>	—	2560 × 1600 <sup>†</sup> (DVI), 2048 × 1536 <sup>‡</sup> (RGB/VGA), 1920 × 1080 (Component)		1920 × 1080
<b>Maximum card dimensions</b>	L: 9.50 in / W: 0.75 in / H: 4.407 in L: 24.13 cm / W: 1.91 cm / H: 11.2 cm	L: 9.50 in / W: 0.75 in / H: 4.407 in L: 24.13 cm / W: 1.91 cm / H: 11.2 cm	L: 9.50 in / W: 0.75 in / H: 4.407 in L: 24.13 cm / W: 1.91 cm / H: 11.2 cm	L: 6.60 in / W: 0.75 in / H: 4.407 in L: 16.80 cm / W: 1.91 cm / H: 11.2 cm
<b>Regulatory compliance</b>	Class A: FCC, CE, RCM, VCCI, ICES-3, CSA, KC			

\* Certain limitations may apply. Matrox strongly recommends that you review the HDCP web site ([www.digital-cp.com](http://www.digital-cp.com)) and make sure you understand your legal obligations and responsibility.

† At 30 Hz. For specific requirements, contact Matrox.

‡ At 47 Hz. For specific requirements, contact Matrox.

## Mura MPX-V8, MPX-V16

	Mura MPX-V8	Mura MPX-V16
<b>Card type</b>	PCIe x4 1.0	PCIe x4 1.0
<b>Form factor</b>	ATX	ATX
<b>Memory</b>	128 MB DDR SDRAM	256 MB DDR SDRAM
<b>Input formats supported</b>	S-video, Composite	S-video, Composite
<b>Connectors</b>	1× DVI-I	2× DVI-I
<b>Outputs supported</b>	—	—
<b>Inputs supported</b>	8	16
<b>Maximum input resolution</b>	NTSC/PAL/SECAM	NTSC/PAL/SECAM
<b>Maximum card dimensions</b>	L: 8.10 in / W: 0.75 in / H: 4.376 in L: 20.6 cm / W: 1.91 cm / H: 11.1 cm	
<b>Regulatory compliance</b>	Class A: FCC, CE, RCM, VCCI, ICES-3, CSA, KC	

## Environmental

<b>Temperature, operational</b>	Mura MPX Series: 0 to 40 °C (32 to 104 °F) Mura IPX Series: 0 to 45 °C (32 to 113 °F)
<b>Temperature, non-operational storage and transportation</b>	Mura MPX Series and Mura IPX Series: -40 to 65 °C (-40 to 149 °F)
<b>Humidity, operational (indoor)</b>	20 to 80% (non-condensing)
<b>Humidity, non-operational storage and transportation</b>	10% to 95% (non-condensing)
<b>Atmospheric pressure, operational</b>	650hPa (3,580 meters / 11,745 feet) to 1013hPa (0 meters / 0 feet)
<b>Atmospheric pressure, non-operational and transportation</b>	192hPa (12,000 meters / 39,370 feet) to 1020hPa (-50 meters / -164 feet)



## Mean Time Before Failure (MTBF)

	MTBF*
<b>MURAIPXI-E4SHF</b>	74.44 years or 652,499 hours
<b>MURAIPXI-E4SF</b>	7.21 years or 63,217 hours
<b>MURAIPXI-E2MHF</b>	75.28 years or 659,887 hours
<b>MURAIPXI-E2MF</b>	7.22 years or 63,286 hours
<b>MURAIPXI-D2MHF</b>	75.28 years or 659,887 hours
<b>MURAIPXI-D2MF</b>	7.22 years or 63,286 hours
<b>MURAIPXO-D4LHF</b>	72.63 years or 636,707 hours
<b>MURAIPXO-D4LF</b>	6.56 years or 57,469 hours
<b>MURAIPXI-E4JHF</b>	76.51 years or 670,700 hours
<b>MURAIPXI-E4JF</b>	7.23 years or 63,384 hours
<b>MURAIPXI-D4JHF</b>	76.51 years or 670,700 hours
<b>MURAIPXI-D4JF</b>	7.23 years or 63,384 hours
<b>Mura MPX-4/4 †</b>	71.11 years or 622,944 hours
<b>Mura MPX-4/2 †</b>	75.41 years or 660,615 hours
<b>Mura MPX-4/0 †</b>	90.03 years or 788,631 hours
<b>Mura MPX-V16 †</b>	89.48 years or 783,822 hours
<b>Mura MPX-V8 †</b>	142.26 years or 1,246,230 hours
<b>Mura MPX-SDI †</b>	102.33 years or 896,427 hours

\* Calculated at operating temperature of 40 °C, operating 24 hours/day. For more information, contact your Matrox representative.

† Applies to Mura MPX Series fanless SKUs only.

## Notes

- The display resolutions and refresh rates available depend on your Matrox card, driver, software monitor settings, and monitor. For information on the capabilities of your monitor, see your monitor documentation.

# Appendix A – Matrox product overview

## Supported product combinations

	Mura IPX Series (capture cards)	Mura MPX Series	C-Series	D-Series	QuadHead2Go	Third-party graphics hardware*
<b>Mura IPX Series 4K capture cards</b>	✓†	✓	✓	✓	✓	✓
<b>Mura MPX Series</b>	✓	✓	—	—	✓	—
<b>C-Series</b>	✓	—	✓	—	✓	—
<b>D-Series</b>	✓	—	—	✓	✓	—
<b>Matrox QuadHead2Go Series</b>	✓	✓	✓	✓	✓	✓
<b>Third party-graphics hardware</b>	✓	—	—	—	✓	✓

\* For more information on supported third-party graphics hardware, see the release notes. For information on how to configure your system, see "Matrox System Builder's Guide."

† Supports streams from Mura IPX Series cards as IP sources.

## Supported output types

	Mura IPX Series (display card)	Mura IPX Series (capture cards) and other Matrox graphics hardware (or third-party hardware*)	Mura MPX Series and/or Mura IPX Series (capture cards)
DisplayPort™	<ul style="list-style-type: none"> <li>▪ MURAI PXO-D4LF</li> <li>▪ MURAI PXO-D4LHF</li> </ul>	<ul style="list-style-type: none"> <li>▪ D1480</li> <li>▪ C680</li> <li>▪ Third-party hardware</li> </ul>	—
HDMI®	—	<ul style="list-style-type: none"> <li>▪ D1450</li> <li>▪ C900</li> <li>▪ Third-party hardware</li> </ul>	—
DVI	—	<ul style="list-style-type: none"> <li>▪ C900</li> <li>▪ Third-party hardware</li> </ul>	<ul style="list-style-type: none"> <li>▪ Mura MPX-4/4</li> <li>▪ Mura MPX-4/2</li> <li>▪ Mura MPX-4/0</li> <li>▪ Mura MPX-SDI</li> </ul>
HD-15	—	—	<ul style="list-style-type: none"> <li>▪ Mura MPX-4/4</li> <li>▪ Mura MPX-4/2</li> <li>▪ Mura MPX-4/0</li> <li>▪ Mura MPX-SDI</li> </ul>

\* For more information on supported third-party graphics cards, see the release notes. For information on how to configure your system, see "Matrox System Builder's Guide."

## Supported input types

	Mura IPX Series (display card)	Mura IPX Series (capture cards) and other Matrox graphics hardware (or third-party hardware*)	Mura MPX Series and/or Mura IPX Series (capture cards)
IP source	<ul style="list-style-type: none"> <li>▪ MURAI PXO-D4LF</li> <li>▪ MURAI PXO-D4LHF</li> </ul>	<ul style="list-style-type: none"> <li>▪ MURAI PXI-E4SF</li> <li>▪ MURAI PXI-E4SHF</li> <li>▪ MURAI PXI-E2MF</li> <li>▪ MURAI PXI-E2MHF</li> <li>▪ MURAI PXI-D2MF</li> <li>▪ MURAI PXI-D2MHF</li> <li>▪ MURAI PXI-E4JF</li> <li>▪ MURAI PXI-E4JHF</li> <li>▪ MURAI PXI-D4JF</li> <li>▪ MURAI PXI-D4JHF</li> </ul>	<ul style="list-style-type: none"> <li>▪ MURAI PXI-E2MF</li> <li>▪ MURAI PXI-E2MHF</li> <li>▪ MURAI PXI-D2MF</li> <li>▪ MURAI PXI-D2MHF</li> <li>▪ MURAI PXI-E4JF</li> <li>▪ MURAI PXI-E4JHF</li> <li>▪ MURAI PXI-D4JF</li> <li>▪ MURAI PXI-D4JHF</li> </ul>
DisplayPort 1.2	—	<ul style="list-style-type: none"> <li>▪ MURAI PXI-E2MF</li> <li>▪ MURAI PXI-E2MHF</li> <li>▪ MURAI PXI-D2MF</li> <li>▪ MURAI PXI-D2MHF</li> </ul>	<ul style="list-style-type: none"> <li>▪ MURAI PXI-E2MF</li> <li>▪ MURAI PXI-E2MHF</li> <li>▪ MURAI PXI-D2MF</li> <li>▪ MURAI PXI-D2MHF</li> </ul>

	<b>Mura IPX Series (display card)</b>	<b>Mura IPX Series (capture cards) and other Matrox graphics hardware (or third-party hardware*)</b>	<b>Mura MPX Series and/or Mura IPX Series (capture cards)</b>
<b>HDMI</b>	—	<ul style="list-style-type: none"> <li>▪ MURAIPXI-E2MF</li> <li>▪ MURAIPXI-E2MHF</li> <li>▪ MURAIPXI-D2MF</li> <li>▪ MURAIPXI-D2MHF</li> <li>▪ MURAIPXI-E4JF</li> <li>▪ MURAIPXI-E4JHF</li> <li>▪ MURAIPXI-D4JF</li> <li>▪ MURAIPXI-D4JHF</li> </ul>	<ul style="list-style-type: none"> <li>▪ MURAIPXI-E2MF</li> <li>▪ MURAIPXI-E2MHF</li> <li>▪ MURAIPXI-D2MF</li> <li>▪ MURAIPXI-D2MHF</li> <li>▪ MURAIPXI-E4JF</li> <li>▪ MURAIPXI-E4JHF</li> <li>▪ MURAIPXI-D4JF</li> <li>▪ MURAIPXI-D4JHF</li> </ul>
<b>DVI</b>	—	<ul style="list-style-type: none"> <li>▪ MURAIPXI-E2MF</li> <li>▪ MURAIPXI-E2MHF</li> <li>▪ MURAIPXI-D2MF</li> <li>▪ MURAIPXI-D2MHF</li> <li>▪ MURAIPXI-E4JF</li> <li>▪ MURAIPXI-E4JHF</li> <li>▪ MURAIPXI-D4JF</li> <li>▪ MURAIPXI-D4JHF</li> </ul>	<ul style="list-style-type: none"> <li>▪ MURAIPXI-E2MF</li> <li>▪ MURAIPXI-E2MHF</li> <li>▪ MURAIPXI-D2MF</li> <li>▪ MURAIPXI-D2MHF</li> <li>▪ MURAIPXI-E4JF</li> <li>▪ MURAIPXI-E4JHF</li> <li>▪ MURAIPXI-D4JF</li> <li>▪ MURAIPXI-D4JHF</li> <li>▪ Mura MPX-4/4</li> <li>▪ Mura MPX-4/2</li> </ul>
<b>HD-15</b>	—	—	<ul style="list-style-type: none"> <li>▪ Mura MPX-4/4</li> <li>▪ Mura MPX-4/2</li> </ul>
<b>S-video</b>	—	—	<ul style="list-style-type: none"> <li>▪ Mura MPX-4/4</li> <li>▪ Mura MPX-4/2</li> <li>▪ Mura MPX-V16</li> <li>▪ Mura MPX-V8</li> </ul>
<b>Composite video (RCA or BNC)</b>	—	<ul style="list-style-type: none"> <li>▪ MURAIPXI-E4SF</li> <li>▪ MURAIPXI-E4SHF</li> </ul>	<ul style="list-style-type: none"> <li>▪ Mura MPX-SDI</li> <li>▪ Mura MPX-V16</li> <li>▪ Mura MPX-V8</li> </ul>
<b>Component video</b>	—	—	<ul style="list-style-type: none"> <li>▪ Mura MPX-4/4</li> <li>▪ Mura MPX-4/2</li> </ul>

\* For more information on supported third-party graphics cards, see the release notes. For information on how to configure your system, see "Matrox System Builder's Guide."

## Supported product capabilities

	Mura IPX Series* (capture cards) with other Matrox hardware (or third-party hardware†)	Mura MPX Series and/or Mura IPX Series (capture cards)
<b>Supported operating system</b>	<ul style="list-style-type: none"> <li>▪ Windows® Server® 2019</li> <li>▪ Windows® 10 (including Windows® 10 IoT)</li> <li>▪ Windows® Server® 2016</li> <li>▪ Windows® Server® 2008 R2</li> <li>▪ Windows® 7</li> <li>▪ Windows® Embedded Standard 7</li> <li>▪ Linux®</li> </ul>	<ul style="list-style-type: none"> <li>▪ Windows® Embedded Standard 7 (64-bit)</li> <li>▪ Windows® 7 Professional (64-bit)</li> <li>▪ Windows® 7 Professional for Embedded Systems (64-bit)</li> <li>▪ Windows® Server® 2008 R2 (64-bit)</li> </ul>
<b>Maximum number of output cards per controller</b>	<ul style="list-style-type: none"> <li>▪ 2x C-Series (C900 or C680)</li> <li>▪ 4x D-Series (D1480 or D1450)</li> <li>▪ Third-party hardware</li> </ul>	14

\* A Mura IPX Series display card is a standalone controller that doesn't require an operating system.

† For more information on supported third-party graphics cards, see the release notes. For information on how to configure your system, see "Matrox System Builder's Guide."

## Software Development Kits (SDKs)

	DirectShow support	Matrox Network API	Matrox VWLib API	Matrox DWC API	Matrox QuadHead2Go REST API
Mura IPX Capture Series + Mura MPX Series	—	✓	—	✓	—
Mura IPX Capture Series + C-Series*	✓	✓	✓	—	—
Mura IPX Capture Series + D-Series	✓	✓	✓	—	—
Mura IPX Capture Series + Third party-graphics hardware	✓	✓	✓	—	—
Matrox IPX Decode & Display Card†	—	✓	—	—	—
Matrox QuadHead2Go Series	—	—	—	—	✓

\* Matrox C420 isn't supported.

† This product works as a standalone multi-viewer that doesn't require an operating system.

---

## Matrox MuraControl software



Use Matrox MuraControl for Windows to manage your Matrox display wall. With MuraControl software, you can create, save, and edit layouts so your source content appears where and how you want it.

Matrox MuraControl for Windows supports the following Matrox hardware:

- Matrox Mura IPX Series
- Matrox Mura MPX Series
- Matrox D-Series
- Matrox C-Series (C900 and C680 only)

## Obtaining MuraControl software

Matrox MuraControl for Windows software is available for download on the Matrox web site ([www.matrox.com/graphics/en/products/video-wall/muracontrol](http://www.matrox.com/graphics/en/products/video-wall/muracontrol)).

## More information

To run Matrox MuraControl for Windows, a USB dongle (hardware lock) is required.

A 21-day free trial of Matrox MuraControl for Windows is available for download. Following the expiry of the 21-day free trial, you must purchase a software license in the form of a USB dongle to continue using MuraControl for Windows software.

To purchase a software license, contact your Matrox representative.

For more information on MuraControl software, see the Matrox MuraControl user guide.

---

# Appendix B – Firewall requirements

The following are the firewall requirements for your display wall system and for a network when using Network API, MuraControl, or a Mura IPX Series product.

---

## Network API and MuraControl

The following are the firewall requirements when using Network API or MuraControl through the network to configure your display wall controller.

Network ports	Type	Inbound	Outbound	Functionality
23	TCP	✓	✓	<b>Telnet:</b> Telnet commands
46272	TCP	✓	✓	<b>HTTPS:</b> Authentication

---

## Display wall system

The following are the requirements for a network firewall present on a network with a Mura IPX Series product.

Network ports	Type	Inbound	Outbound	Functionality
69	UDP	—	✓	<b>DHCP:</b> DHCP client
123	UDP	✓	✓	<b>NTP:</b> Network Time Protocol
161	UDP	✓	✓	<b>SNMP:</b> Network management – public community string
1500	UDP	✓	✓	<b>MPEG-2 TS:</b> Streaming (configurable)
1500	UDP	✓	✓	<b>SRT:</b> Streaming (configurable)
1900	UDP	✓	✓	<b>UPnP:</b> Microsoft SSDP for discovery of UPnP devices
554, 8554*	TCP	✓	✓	<b>RTSP:</b> Streaming (configurable)
16000+	UDP	✓	✓	<b>RTP/RTCP:</b> Audio and video streams and control

\* Default ports. Actual ports may vary.

---

## Matrox IPX Updater

The following are the firewall requirements for a system running the network version of the Matrox IPX Updater.

Network Port	Type	Inbound	Outbound	Functionality
20,21	TCP	—	✓	<b>FTP:</b> File upload
22*	TCP	✓	✓	<b>SSH:</b> Firmware update
443*	TCP	—	✓	<b>HTTPS:</b> Authentication
1900*	UDP	✓	✓	<b>UPnP:</b> Microsoft SSDP for discovery of UPnP devices

\* Minimum requirements.

---

## Accessing your Windows Firewall settings



**Note:** You may need administrator rights to modify your Windows Firewall settings. For more information, see Windows documentation or contact your system administrator.

To access your Windows Firewall settings:

Windows 10/7 –

- 1** Windows 10 – Click **Start** → **Settings** → **Network & Internet** → **Ethernet** → **Windows Firewall**.
- 2** Windows 10 – In the left panel, click **Advanced Settings**.



---

# Appendix C – Matrox secure cable solution

Mini HDMI® – MURAI PXI-E4JF, MURAI PXI-E4JHF, MURAI PXI-D4JF, MURAI PXI-D4JHF

1

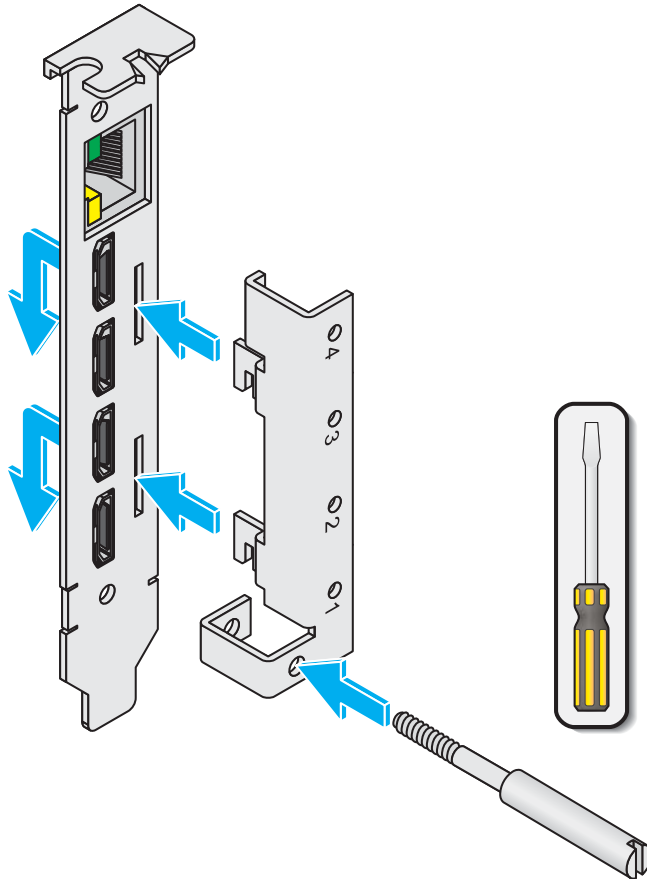

2

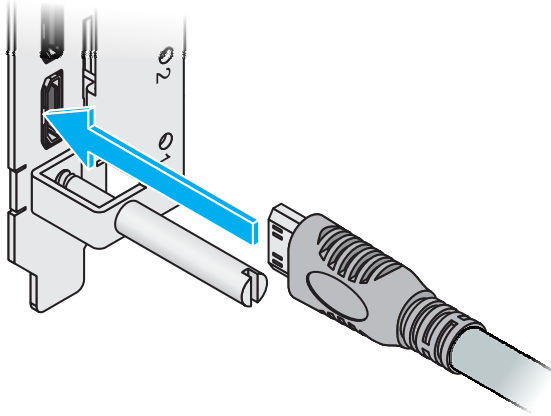

3

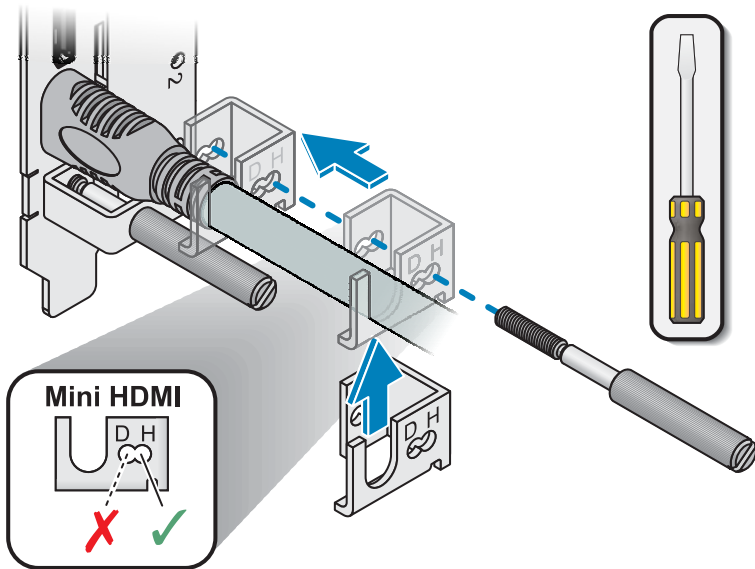

Mini DisplayPort™

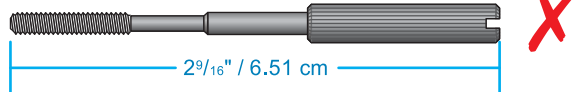

Mini HDMI®

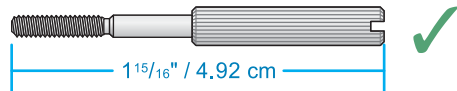

# Mini DisplayPort™ – MURAIPXO-D4LF • MURAIPXO-D4LHF

1

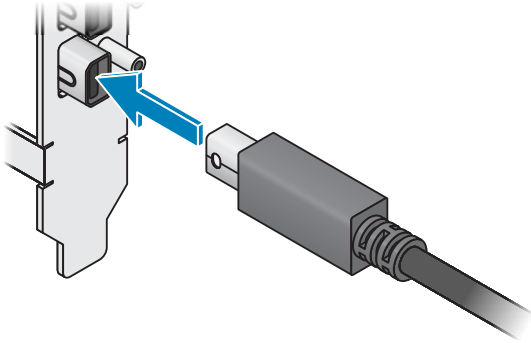

2

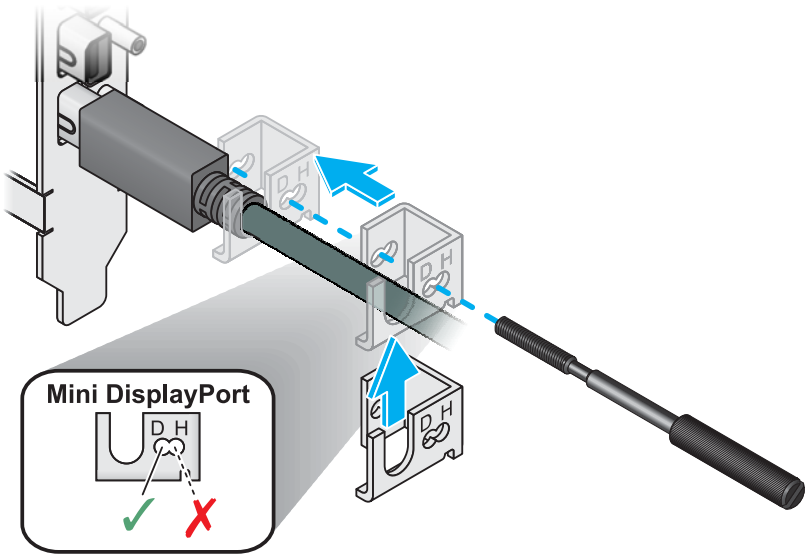

Mini DisplayPort™

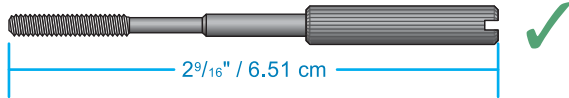

Mini HDMI®

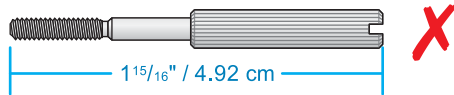

---

# Customer support

---

## Matrox web

Our web site has product literature, press releases, technical material, a sales office list, trade show information, and other relevant material. Visit the Matrox Graphics web site at [www.matrox.com/graphics](http://www.matrox.com/graphics).

---

## Technical support

Matrox values your business and offers professional support for your Matrox product. If you have a problem, we recommend you follow the procedure below for the quickest results.

- 1 Contact your integrator** – This is usually the quickest and most effective method of technical assistance. Your integrator is familiar with your complete system. In the case of hardware warranty assistance, the product must be returned to the integrator, who will return it to Matrox.
- 2** If your Matrox product was provided by your computer manufacturer, contact this manufacturer. For contact information, see your computer documentation or contact the vendor.
- 3 Direct Matrox technical support** – If you still can't resolve a problem (and your Matrox product wasn't provided by your computer manufacturer), you can get technical assistance by contacting Matrox technical support at [dwcsupport@matrox.com](mailto:dwcsupport@matrox.com).

---

## Information we need

Please give a complete description of the problem, and include:

- Matrox product serial number, model number, revision number, and firmware version.
- For Matrox cards – driver type and version, and memory address at which the Matrox card is installed.
- Computer brand and model name.
- Monitor brand and model name.
- Operating system, version, and service pack.
- Brand and model of any other cards and devices installed on your system.

---

## Program specific problems

If a problem appears with a specific program, please give us the following information:

- Display settings (color palette, display resolution, and so on) applied when the problem occurs.
- If possible, take note of the file and segment address that caused the problem.
- Detailed steps known to cause the bug, so we can reproduce it.

---

## Software package download

**From your integrator or manufacturer** – If your product was purchased through an integrator or a manufacturer, contact them for the latest display driver, firmware, software, and system utilities as they're familiar with your complete system. An integrator or a manufacturer may also have directives regarding software updates.

**Directly from Matrox** – A more recent software package may support more features and may offer increased capabilities (such as higher display resolutions). Matrox makes the latest display drivers, firmware, software, and system utilities available on the Matrox Technical Support Web site ([www.matrox.com/graphics/en/support/drivers](http://www.matrox.com/graphics/en/support/drivers)).

---

## View your warranty information

Matrox makes warranty information available on the Matrox site ([www.matrox.com/graphics/en/support/warranty/](http://www.matrox.com/graphics/en/support/warranty/)).

---

## View the third party software notices

Matrox makes third party software notices and/or additional terms and conditions available on the Matrox site (<https://thirdpartylicenses.matrox.com>).

---

## Register your Matrox product

Please register online ([www.matrox.com/graphics/en/registration](http://www.matrox.com/graphics/en/registration)) to receive new product announcements and information on special offers and upcoming events.

---

**Hot surface** Allow hot surfaces to cool before touching your Matrox unit.

**Surface chaude** Laissez refroidir les surfaces chaudes avant de toucher votre appareil Matrox.

**Battery replacement** The battery is non replaceable. To dispose of your product, see [www.matrox.com/environment/weee](http://www.matrox.com/environment/weee).



**Remplacement des piles** La pile n'est pas remplaçable. Pour se défaire du produit, voir [www.matrox.com/environment/weee](http://www.matrox.com/environment/weee).

---

#### USA

---

### FCC Compliance Statement

**Remark for the Matrox hardware products supported by this guide** This equipment has been tested and found to comply with the limits for a Class B digital device, pursuant to Part 15 of the FCC Rules. These limits are designed to provide reasonable protection against harmful interference in a residential installation. This equipment generates, uses and can radiate radio frequency energy and, if not installed and used in accordance with the instructions, may cause harmful interference to radio communications. However, there is no guarantee that interference will not occur in a particular installation. If this equipment causes harmful interference to radio or television reception, which can be determined by turning the equipment off and on, the user is encouraged to try to correct the interference by one or more of the following measures: • Reorient or relocate the receiving antenna • Increase the separation between the equipment and receiver • Connect the equipment into an outlet on a circuit different from that to which the receiver is connected • Consult the dealer or an experienced radio/TV technician for help.



**WARNING** Changes or modifications to this unit not expressly approved by the party responsible for the compliance could void the user's authority to operate this equipment.

### Declaration of conformity of a Class B digital device according to the FCC rules

**We, the Responsible Party** Matrox, 2002 Ridge Road, Champlain, NY 12919 • Telephone: (514) 822-6000 (extension 2026) • Attention: Conformity Group Matrox

**Declaration** The Matrox hardware products supported by this guide comply with Part 15 of the FCC Rules. Operation is subject to the following two conditions: (1) these devices may not cause harmful interference, and (2) these devices must accept any interference received, including interference that may cause undesired operation. Any question regarding this declaration should be forwarded to the above coordinates.

---

#### CANADA

---

### (English) Innovation, Science and Economic Development Canada

**Remark for the Matrox hardware products supported by this guide** These digital devices do not exceed the Class B limits for radio noise emission from digital devices set out in the Radio Interference Regulation of Industry Canada.

### (Français) Innovation, Sciences et Développement économique Canada

**Remarque sur les produits matériels Matrox couverts par ce guide** Ces appareils numériques n'émettent aucun bruit radioélectrique dépassant les limites applicables aux appareils numériques de Classe B prescrites dans le Règlement sur le brouillage radioélectrique édicté par Industrie Canada.

---

#### USA

---

### FCC Compliance Statement

**Remark for the Matrox hardware products supported by this guide** This equipment has been tested and found to comply with the limits for a Class A digital device, pursuant to Part 15 of the FCC Rules. These limits are designed to provide reasonable protection against harmful interference when the equipment is operated in a commercial environment. This equipment generates, uses, and can radiate radio frequency energy and, if not installed and used in accordance with the instructions manual, may cause harmful interference to radio communications. Operation of this equipment in a residential area is likely to cause harmful interference in which case the user will be required to correct the interference at his own expense.

**WARNING** Changes or modifications to this unit not expressly approved by the party responsible for the compliance could void the user's authority to operate this equipment. The use of shielded cables for connection of the monitor to the card is required to meet FCC requirements.

---

**CANADA**

---

**(English) Innovation, Science and Economic Development Canada**

**Remark for the Matrox hardware products supported by this guide** These digital apparatus does not exceed the Class A limits for radio noise emission from digital devices set out in the Radio Interference Regulation of Industry Canada.

**(Français) Innovation, Sciences et Développement économique Canada**

**Remarque sur les produits matériels Matrox couverts par ce guide** Ce présent appareil numérique n'émet aucun bruit radioélectrique dépassant les limites applicables aux appareils numériques de Classe A prescrites dans le Règlement sur le brouillage radioélectrique édicté par Industrie Canada.

---

**JAPAN**

---

**VCCI Compliance Statement**

**Remark for the Matrox hardware products supported by this guide** This is a Class B product based on the standard of the Voluntary Control Council for Interference from Information Technology Equipment (VCCI). If this is used near a radio or television receiver in a domestic environment, it may cause radio interference. Install and use the equipment according to the instruction manual.



この装置は、クラスB情報技術装置です。この装置は、家庭環境で使用することを目的としていますが、この装置がラジオやテレビジョン受信機に近接して使用されると、受信障害を引き起こすことがあります。

取扱説明書に従って正しい取り扱いをして下さい。 VCCI-B

---

**JAPAN**

---

**VCCI Compliance Statement**

**Remark for the Matrox hardware products supported by this guide** This is a Class A product based on the standard of the Voluntary Control Council for Interference by Information Technology Equipment (VCCI). If this equipment is used in a domestic environment, radio disturbance may occur, in which case, the user may be required to take corrective actions.

この装置は、クラスA情報技術装置です。この装置を家庭環境で使用すると電波妨害を引き起こすことがあります。この場合には使用者が適切な対策を講ずるよう要求されることがあります。 VCCI-A

---

**KOREA**

---

**B 급 기기 (가정용 방송통신기자재)**

이 기기는 가정용 (B 급) 전자파적합기기로서 주로 가정에서 사용하는 것을 목적으로 하며, 모든 지역에서 사용할 수 있습니다.

---

**KOREA**

---

**A 급 기기 ( 업무용 방송통신기자재 )**

이 기기는 업무용 (A 급) 전자파적합기기로서 판 매자 또는 사용자는 이 점을 주의하시기 바  
라 며 , 가정외의 지역에서 사용하는 것을 목적으 로 합니다 .

---

**EUROPE**

---

**(English) European user's information – Information on Conformity**

**Remark for the Matrox hardware products supported by this guide** These devices comply with EC Directive 2014/30/EU for a Class B digital device. They have been tested and found to comply with EN55032/CISPR32 and EN55024/CISPR24. In a domestic environment these products may cause radio interference in which case the user may be required to take adequate measures. These products have been tested in a typical class B compliant host system. It is assumed that these products will also achieve compliance in any class B compliant system.

**(Français) Informations aux utilisateurs Européens – Informations sur la conformité**

**Remarque sur les produits matériels Matrox couverts par ce guide** Ces unités sont conformes à la directive communautaire 2014/30/EU pour les unités numériques de classe B. Les tests effectués ont prouvé qu'elles sont conformes aux normes EN55032/CISPR32 et EN55024/CISPR24. Le fonctionnement de ces produits dans un environnement résidentiel peut causer des interférences radio, dans ce cas l'utilisateur peut être amené à prendre les mesures appropriées. Ces produits ont été testés dans un système hôte typique compatible classe B. On suppose qu'ils présenteront la même compatibilité dans tout système compatible classe B.

**(Deutsch) Information für europäische Anwender – Konformitäts-Informationen**

**Anmerkung für die Matrox Hardware-Produktunterstützung durch dieses Handbuch** Diese Geräte entsprechen EC Direktive 2014/30/EU für ein digitales Gerät Klasse B. Sie wurden getestet und entsprechen demnach EN55032/CISPR32 und EN55024/CISPR24. In einer Wohnumgebung können diese Produkte Funkinterferenzen erzeugen, und der Benutzer kann genötigt sein, entsprechende Maßnahmen zu ergreifen. Diese Produkt wurden in einem typischen, der Klasse B entsprechenden, Host-System getestet. Es wird davon ausgegangen, daß diese Produkte auch in jedem Klasse B entsprechenden System entsprechend funktionieren.

**(Italiano) Informazioni per gli utenti europei – Informazioni sulla conformità**

**Nota per i prodotti hardware Matrox supportati da questa guida** Questi dispositivi sono conformi alla direttiva CEE 2014/30/EU relativamente ai dispositivi digitali di Classe B. Sono stati provati e sono risultati conformi alle norme EN55032/CISPR32 e EN55024/CISPR24. In un ambiente domestico, questi prodotti possono causare radiointerferenze, nel qual caso all'utente potrebbe venire richiesto di prendere le misure adeguate. Questi prodotti sono stati provati in un tipico sistema host conforme alla classe B. Inoltre, si dà per scontato che questi prodotti acquisiranno la conformità in qualsiasi sistema conforme alla classe B.

**(Español) Información para usuarios europeos – Información sobre la conformidad**

**Observación referente a los productos de hardware de Matrox apoyados por este manual** Estos dispositivos cumplen con la directiva de la CE 2014/30/EU para dispositivos digitales de Clase B. Dichos dispositivos han sido sometidos a prueba y se ha comprobado que cumplen con las normas EN55032/CISPR32 y EN55024/CISPR24. En entornos residenciales, estos productos pueden causar interferencias en las comunicaciones por radio; en tal caso el usuario deberá adoptar las medidas adecuadas. Se supone que estos productos cumplirán también con las normas en cualquier sistema que responda a los requisitos de la clase B.

---

**EUROPE**

---

**(English) European user's information – Declaration of Conformity**

**Remark for the Matrox hardware products supported by this guide** These devices comply with EC Directive 2014/30/EU for a Class A digital device. They have been tested and found to comply with EN55032/CISPR32 and EN55024/CISPR24. In a domestic environment these products may cause radio interference in which case the user may be required to take adequate measures. To meet EC requirements, shielded cables must be



used to connect the monitor and other peripherals to the card. These products have been tested in a typical class A compliant host system. It is assumed that these products will also achieve compliance in any class A compliant system.

### **(Français) Informations aux utilisateurs Européens – Déclaration de conformité**

**Remarque sur les produits matériels Matrox couverts par ce guide** Ces unités sont conformes à la directive communautaire 2014/30/EU pour les unités numériques de classe A. Les tests effectués ont prouvé qu'elles sont conformes aux normes EN55032/CISPR32 et EN55024/CISPR24. Le fonctionnement de ces produits dans un environnement résidentiel peut causer des interférences radio, dans ce cas l'utilisateur peut être amené à prendre les mesures appropriées. Pour respecter les impératifs communautaires, les câbles de connexion entre le moniteur ou autres périphériques et la carte doivent être blindés. Ces produits ont été testés dans un système hôte typique compatible classe A. On suppose qu'ils présenteront la même compatibilité dans tout système compatible classe A.

### **(Deutsch) Information für europäische Anwender – Konformitätserklärung**

**Anmerkung für die Matrox Hardware-Produktunterstützung durch dieses Handbuch** Diese Geräte entsprechen EC Direktive 2014/30/EU für ein digitales Gerät Klasse A. Sie wurden getestet und entsprechen demnach EN55032/CISPR32 und EN55024/CISPR24. In einer Wohnumgebung können diese Produkte Funkinterferenzen erzeugen, und der Benutzer kann genötigt sein, entsprechende Maßnahmen zu ergreifen. Um EG-Anforderungen zu entsprechen, müssen zum Anschließen des Monitors und anderer Peripheriegeräte an die Karte abgeschirmte Kabel verwendet werden. Diese Produkt wurden in einem typischen, der Klasse A entsprechenden, Host-System getestet. Es wird davon ausgegangen, daß diese Produkte auch in jedem Klasse A entsprechenden System entsprechend funktionieren.

### **(Italiano) Informazioni per gli utenti europei – Dichiarazione di conformità**

**Nota per i prodotti hardware Matrox supportati da questa guida** Questi dispositivi sono conformi alla direttiva CEE 2014/30/EU relativamente ai dispositivi digitali di Classe A. Sono stati provati e sono risultati conformi alle norme EN55032/CISPR32 e EN55024/CISPR24. In un ambiente domestico, questi prodotti possono causare radiointerferenze, nel qual caso all'utente potrebbe venire richiesto di prendere le misure adeguate. Per soddisfare i requisiti CEE, il monitor e le altre periferiche vanno collegati alla scheda grafica con cavi schermati. Questi prodotti sono stati provati in un tipico sistema host conforme alla classe A. Inoltre, si dà per scontato che questi prodotti acquisiranno la conformità in qualsiasi sistema conforme alla classe A.

### **(Español) Información para usuarios europeos – Declaración de conformidad**

**Observación referente a los productos de hardware de Matrox apoyados por este manual** Estos dispositivos cumplen con la directiva de la CE 2014/30/EU para dispositivos digitales de Clase A. Dichos dispositivos han sido sometidos a prueba y se ha comprobado que cumplen con las normas EN55032/CISPR32 y EN55024/CISPR24. En entornos residenciales, estos productos pueden causar interferencias en las comunicaciones por radio; en tal caso el usuario deberá adoptar las medidas adecuadas. Para satisfacer las disposiciones de la CE, deberán utilizarse cables apantallados para conectar el monitor y demás periféricos a la tarjeta. Estos productos han sido sometidos a prueba en un típico sistema anfitrión que responde a los requisitos de la clase A. Se supone que estos productos cumplirán también con las normas en cualquier sistema que responda a los requisitos de la clase A.

---

#### **ROVI CORPORATION**

---

**(English)** This item incorporates copy protection technology that is protected by U.S. patent(s) and other intellectual property rights of Rovi Corporation. Reverse engineering and disassembly are prohibited.

**(Français)** Ce produit intègre une technologie de protection des droits d'auteur qui est protégée par un ou plusieurs brevets américains et par d'autres droits de propriété intellectuelle de Rovi Corporation. L'ingénierie inverse et le désassemblage sont interdits.

**(Deutsch)** Dieses Produkt enthält Kopierschutztechnologien, die durch US-Patent(e) und andere Rechte am geistigen Eigentum der Rovi Corporation geschützt ist. Reverse Engineering und Demontage sind verboten.

**(Italiano)** Questo prodotto incorpora la tecnologia di protezione di copia protetta da uno o più brevetti USA e da altri diritti di proprietà intellettuale di Rovi Corporation. È vietato decodificare o disassemblare il prodotto.

**(Español)** Este producto incorpora tecnología de protección de copia que está protegida por patente(s) de EE. UU. y por otros derechos de propiedad intelectual de Rovi Corporation. La ingeniería inversa y el desmontaje están prohibidos.

---

## EUROPE

---

### **(English) European user's information – Directive on Waste Electrical and Electronic Equipment (WEEE)**

Please refer to the Matrox Web site ([www.matrox.com/environment/en/weee](http://www.matrox.com/environment/en/weee)) for recycling information.



### **(Français) Informations aux utilisateurs Européens – Règlementation des déchets d'équipements électriques et électroniques (DEEE)**

Se référer au site Web de Matrox ([www.matrox.com/environment/en/weee](http://www.matrox.com/environment/en/weee)) pour l'information concernant le recyclage.

### **(Deutsch) Information für europäische Anwender – Europäische Regelungen zu Elektro- und Elektronikgeräten (WEEE)**

Bitte wenden Sie sich an der Matrox-Website ([www.matrox.com/environment/en/weee](http://www.matrox.com/environment/en/weee)) für Recycling-Informationen.

### **(Italiano) Informazioni per gli utenti europei – Direttiva sui rifiuti di apparecchiature elettriche ed elettroniche (RAEE)**

Si prega di riferirsi al sito Web Matrox ([www.matrox.com/environment/en/weee](http://www.matrox.com/environment/en/weee)) per le informazioni di riciclaggio.

---

## FRANCE

---

### **Avertissement sur l'épilepsie**

**À lire avant toute utilisation d'un jeu vidéo par vous-même ou votre enfant** Certaines personnes sont susceptibles de faire des crises d'épilepsie ou d'avoir des pertes de conscience à la vue de certains types de lumières clignotantes ou d'éléments fréquents dans notre environnement quotidien. Ces personnes s'exposent à des crises lorsqu'elles regardent certaines images télévisées ou qu'elles jouent à certains jeux vidéo. Ces phénomènes peuvent apparaître alors même que le sujet n'a pas d'antécédent médical ou n'a jamais été confronté à une crise d'épilepsie.

Si vous-même ou un membre de votre famille avez déjà présenté des symptômes liés à l'épilepsie (crise ou perte de conscience) en présence de stimulations lumineuses, veuillez consulter votre médecin avant toute utilisation.

Nous conseillons aux parents d'être attentifs à leurs enfants lorsqu'ils jouent avec des jeux vidéo. Si vous-même ou votre enfant présentez un des symptômes suivants: vertige, trouble de la vision, contraction des yeux ou des muscles, perte de conscience, trouble de l'orientation, mouvement involontaire ou convulsion, veuillez immédiatement cesser de jouer et consultez un médecin.

**Précautions à prendre dans tous les cas pour l'utilisation d'un jeu vidéo** Ne vous tenez pas trop près de l'écran.

- Jouez à bonne distance de l'écran de TV et aussi loin que le permet le cordon de raccordement.
- Utilisez de préférence les jeux de vidéo sur un écran de petite taille.
- Évitez de jouer si vous êtes fatigué ou si vous manquez de sommeil.
- Assurez-vous que vous jouez dans une pièce bien éclairée.
- En cours d'utilisation, faites des pauses de dix à quinze minutes toutes les heures.

---

## **(English) Disclaimer**

THE INFORMATION IN THIS GUIDE IS SUBJECT TO CHANGE AT ANY TIME AND WITHOUT NOTICE.

Matrox Graphics Inc. reserves the right to make changes in specifications at any time and without notice. The information provided by this document is believed to be accurate and reliable at the time it is written. However, no responsibility is assumed by Matrox Graphics Inc. for its use, for its reproduction and/or distribution, in whole or in part; nor for any infringements of patents or other rights of third parties resulting from its use.

---

## **(Français) Responsabilité**

LES INFORMATIONS CONTENUES DANS CE MANUEL PEUVENT ÊTRE MODIFIÉES EN TOUT TEMPS ET CE SANS PRÉAVIS.

Les Graphiques Matrox Inc. se réserve le droit de modifier les spécifications en tout temps et ce sans préavis quelconque. Les informations contenues dans ce manuel sont reconnues comme étant précises et fiables à la date de rédaction. Cependant, Matrox Graphics Inc. n'assume aucune responsabilité concernant leur utilisation, leur reproduction et/ou distribution, en tout ou en partie, ni leur contrefaçon de brevets ou de tout autre droit appartenant à des tiers résultant de leur utilisation. Aucune licence n'est accordée sur aucun brevet ou droit d'exploiter un brevet de Matrox Graphics Inc.

---

## **(Deutsch) Haftungsablehnungserklärung**

DIE IN DIESEM HANDBUCH ENTHALTENEN ANGABEN UND DATEN KÖNNEN OHNE VORHERIGE ANKÜNDIGUNG GEÄNDERT WERDEN.

Die Matrox Graphics Inc. behält sich das Recht vor, jederzeit und ohne Ankündigung technische Daten zu ändern. Zum Zeitpunkt der Erstellung dieses Handbuchs sind die Inhalte korrekt und verlässlich. Weiterhin übernimmt Matrox Graphics Inc. keinerlei Verantwortung für die Benutzung dieses Handbuchs, die Vervielfältigung und/oder Verteilung im Ganzen oder zum Teil; weder für Verstöße gegen Patentrechte noch für andere Rechte Dritter, die aus seinem Gebrauch resultieren mögen. Es werden keinerlei Lizenzrechte gewährt für sämtliche Patente oder Patentrechte der Matrox Graphics Inc.

---

## **(Italiano) Discrezionalità**

LE INFORMAZIONI CONTENUTE NEL PRESENTE DOCUMENTO SONO SOGGETTE A MODIFICHE IN QUALUNQUE MOMENTO E SENZA PREAVVISO.

Matrox Graphics Inc. si riserva il diritto di apportare variazioni di qualunque tipo alle specifiche tecniche in qualunque momento e senza alcun preavviso. Le informazioni contenute in questa documentazione sono ritenute corrette e attendibili al momento della pubblicazione. In ogni caso, non è imputabile a Matrox Graphics Inc. nessuna responsabilità per il loro utilizzo, per la loro distribuzione e/o riproduzione completa o in parte, come nessuna violazione a brevetti o diritti di altri produttori derivante dal loro utilizzo.

---

## **(Español) Renuncia**

LA INFORMACION QUE CONTIENE EL PRESENTE MANUAL ESTA SUJETA A CAMBIOS SIN PREVIO AVISO EN CUALQUIER MOMENTO.

Matrox Graphics Inc. se reserva el derecho de realizar modificaciones en cualquier momento y sin previo aviso. La información facilitada en este documento se considera que es exacta y fiable hasta la fecha de publicación. Sin embargo, Matrox Graphics Inc. no asume ninguna responsabilidad por su uso, por su reproducción y/o distribución parcial o total; ni por cualquier infracción de patentes u otros derechos de terceras partes derivados de su uso. No se concede ninguna licencia bajo cualesquiera patentes o derechos de patentes de Matrox Graphics Inc.

---

## Trademarks • Marques déposées • Warenzeichen • Marchi registrati • Marcas registradas

Matrox Electronic Systems Ltd. /

Matrox Graphics Inc. ....	Matrox <sup>®</sup> , DualHead <sup>®</sup> , Avio <sup>™</sup> , C-Series <sup>™</sup> , D-Series <sup>™</sup> , DualHead2Go <sup>™</sup> , Extio <sup>™</sup> , G400 <sup>™</sup> , G450 <sup>™</sup> , G550 <sup>™</sup> , GXM <sup>™</sup> , Maevex <sup>™</sup> , Marvel <sup>™</sup> , MED2mp <sup>™</sup> , MED2mp-DVI <sup>™</sup> , MED3mp-DVI <sup>™</sup> , MED4mp <sup>™</sup> , MED5mp-DVI <sup>™</sup> , MED5mp <sup>™</sup> , Millennium <sup>™</sup> , MMS <sup>™</sup> , Multi-Monitor Series <sup>™</sup> , MultiDesk <sup>™</sup> , Mura <sup>™</sup> , MuraControl <sup>™</sup> , Mystique <sup>™</sup> , P650 <sup>™</sup> , P690 <sup>™</sup> , P750 <sup>™</sup> , Parhelia <sup>™</sup> , Parhelia <sup>™</sup> APVe, Parhelia-512 <sup>™</sup> , Parhelia-LX <sup>™</sup> , Parhelia HR256 <sup>™</sup> , PJ4OLP <sup>™</sup> , QID <sup>™</sup> , Quad Information Display <sup>™</sup> , RAD <sup>™</sup> , Quick Connect <sup>™</sup> , MaxVIEW <sup>™</sup> , Onyx <sup>™</sup> , PixelTOUCH <sup>™</sup> , PrecisionCAD <sup>™</sup> , Precision SGT <sup>™</sup> , QuadHead2Go <sup>™</sup> , QuickDesk <sup>™</sup> , RAD2mp <sup>™</sup> , RAD3mp <sup>™</sup> , RAD9mp <sup>™</sup> , RADQ2mp <sup>™</sup> , Rainbow Runner <sup>®</sup> , TheatreVUE <sup>™</sup> , TripleHead <sup>™</sup> , TripleHead2Go <sup>™</sup> , VDA <sup>™</sup> , Veos <sup>™</sup> , Xenia <sup>™</sup>
Adobe Systems Inc. ....	Acrobat <sup>®</sup> , Reader <sup>®</sup>
Advanced Micro Devices, Inc. ....	AMD <sup>®</sup>
Apple Computer, Inc. ....	App Store <sup>®</sup> , Apple <sup>®</sup> , iPad <sup>®</sup> , Mac <sup>®</sup> , Mac OS <sup>®</sup>
Belden Inc. ....	Belden <sup>®</sup>
Dolby Laboratories, Inc. ....	Dolby <sup>®</sup> , Dolby Digital <sup>®</sup>
Facebook, Inc. ....	Facebook <sup>®</sup>
Google, Inc. ....	YouTube <sup>®</sup>
HDMI Licensing LLC. ....	HDMI <sup>®</sup>
Intel Corporation ....	Intel <sup>®</sup>
International Business Machines ....	IBM Video Streaming <sup>™</sup>
Linus Torvalds ....	Linux <sup>®</sup>
Microsoft Corporation. ....	Active Directory <sup>®</sup> , Aero <sup>®</sup> , Direct3D <sup>®</sup> , DirectShow <sup>®</sup> , DirectX <sup>®</sup> , Microsoft <sup>®</sup> , MS-DOS <sup>®</sup> , PowerPoint <sup>®</sup> , Windows <sup>®</sup> , Windows NT <sup>®</sup> , Windows Server <sup>®</sup> , Windows Vista <sup>®</sup>
Panopto, Inc. ....	Panopto <sup>™</sup>
PCI-SIG. ....	PCI <sup>™</sup> , PCI-X <sup>®</sup> , PCIe <sup>®</sup> , PCI Express <sup>®</sup>
Radio Corporation of America ....	RCA <sup>®</sup>
RealVNC Ltd. ....	VNC <sup>®</sup>
Restream, Inc. ....	Restream <sup>™</sup>
Rovi Corporation ....	Macrovision <sup>®</sup>
SD-3C, LLC. ....	SD <sup>™</sup> , SDHC <sup>™</sup> , SDXC <sup>™</sup>
Silicon Graphics, Inc. ....	OpenGL <sup>®</sup>
Silicon Image, Inc. ....	PanelLink <sup>®</sup> , TMDS <sup>®</sup>
Twitch Interactive, Inc. ....	Twitch <sup>™</sup>
U.S. Environmental Protection Agency. ....	ENERGY STAR <sup>®</sup>
Video Electronics Standards Association ....	DisplayPort <sup>™</sup>
VideoLAN ....	VideoLAN <sup>®</sup> , VLC <sup>®</sup> , VLC <sup>®</sup> media player
Vimeo, LLC ....	Vimeo <sup>®</sup>

Wibu-Systems..... WIBU®  
Wowza Media Systems, LLC ..... Wowza™

Copyright © 1996-2020 VideoLAN. This logo or a modified version may be used or modified by anyone to refer to the VideoLAN project or any product developed by the VideoLAN team, but does not indicate endorsement by the project.

HTML5 Logo by World Wide Web Consortium ([W3C](http://www.w3.org)). This HTML5 logo is licensed under this Public License (<http://www.creativecommons.org/licenses/by/3.0/legalcode>). The logo has been modified to meet the resolution and size required by this application.

• (English) Registered trademarks are registered in the United States, Canada, and/or other countries. All other nationally and internationally recognized trademarks and tradenames are hereby acknowledged. • (Français) Les marques déposées sont déposées aux États-Unis, au Canada et/ou dans d'autres pays. Toutes les autres marques et tous les autres noms déposés reconnus nationalement ou internationalement sont également reconnus par les présentes. • (Deutsch) Die eingetragenen Warenzeichen sind in den USA, Kanada und/oder anderen Ländern registriert. Alle sonstigen national und international bekannten Warenzeichen und Produktnamen werden hiermit anerkannt. • (Italiano) I marchi registrati sono registrati negli Stati Uniti, in Canada e/o in altri paesi. Tutti gli altri marchi registrati e nomi commerciali riconosciuti a livello nazionale e internazionale sono ugualmente riconosciuti qui. • (Español) Las marcas registradas están registradas en los EE.UU., Canadá u otros países. Por medio del presente se reconocen todas las demás marcas y nombres comerciales reconocidos a nivel nacional e internacional.

**Matrox Graphics Inc.**

1055 Saint Regis Boulevard  
Dorval, Quebec, Canada H9P 2T4  
(514) 822-6000

[graphics@matrox.com](mailto:graphics@matrox.com)  
[www.matrox.com/graphics](http://www.matrox.com/graphics)

**matrox**<sup>®</sup>  
Graphics for Professionals