

Matrox Graphics Architecture

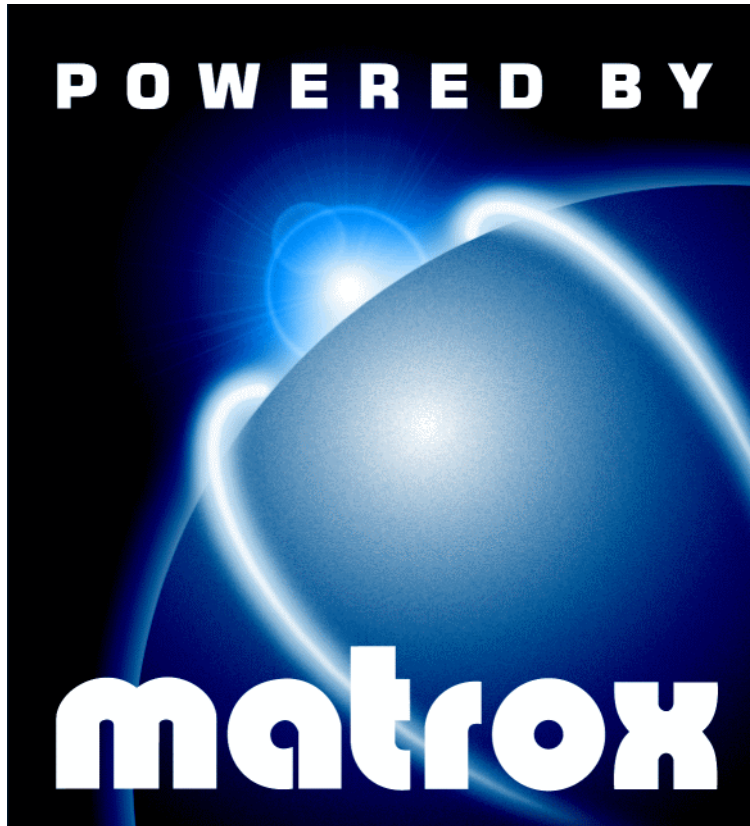

ENGLISH

Matrox Productiva G100 Multi-Monitor Series User Guide

10627-301-0130
1999.03.12

Contents

Using this guide	4
Overview	5
Hardware supplied	5
Software supplied	6
Installation overview	6
Hardware installation	7
Connection setup	11
Quick connection setup	11
SCART information	13
Matrox video input	14
Software installation	15
Matrox PowerDesk software	16
Monitor setup	16
Display setup	17
Multi-display setup	17
Software overview	17
Matrox PC-VCR Remote program	19
Input setting	20
Video file input	20
TV tuner input	21
Video line input	22
Mini remote	23
More features	24
Matrox VidCap driver	26
Video source settings	26
Video format settings	27

Troubleshooting	28
Graphics.....	28
Video	36
Sound.....	40
Display information	42
Graphics.....	42
Video (Matrox TV tuner required)	43
Hardware information	44
Customer support	46
Warranty	49
Index	51

Using this guide

This guide assumes you're familiar with basic functions like click, right-click and double-click, and that you're familiar with the basics of the operating system you're using. Also, we use the following conventions:

- **Bold** for text that appears on-screen, subheadings and labels.
- *Italics* for file names, paths, publication titles, and new terms.
- ***Bold Italics*** for emphasis.
- Keyboard keys in square brackets, with a plus sign separating keys that you press simultaneously. For example: press [Ctrl]+[Alt]+[Del] to restart your computer.
- Arrows (“→”) to separate ordered directions. For example, “click **OK** → **Close** → **OK**” is the same as “click **OK**, then click **Close**, then click **OK**”.
- When viewing online, **green** for cross-references and underlined green for links to Web pages. Click green text to jump to what is being referenced. (To jump to Web pages, your system first needs to have full Internet access.)

More information

We provide additional documentation in help files, *readme* files, and Adobe Acrobat PDF (Portable Document Format) files. To view or print PDF files, use the **Acrobat Reader** program, which you can install from the “Matrox Installation” CD-ROM. This guide is available on the CD-ROM as a PDF file (*Doc\Inst\inst_en.pdf*). The online version of this guide has additional information, including the following sections: “[Customer support](#)”, “[Warranty](#)” and “[Software license agreement](#)”.

For context-sensitive help where available, click the “” icon in the title bar, then click the item you want help on. Right-click a help topic for a pop-up menu that lets you print or copy it.

Also, be sure to check for any last-minute release notes at the end of this manual and in the Matrox CD-ROM *readme* file.

Overview

Thank you for purchasing a Productiva G100 MMS (Multi-Monitor Series) graphics card. Your Matrox MMS card is a high-performance graphics card that plugs into an expansion slot inside your personal computer. This card lets you use 2 or 4 monitors at a time with Windows 98, NT 4.0 or NT 3.51.

The Matrox graphics engine gives you superior performance with Windows, digital video and 3D graphics. To accelerate 3D programs, your Matrox card uses bus mastering and has hardware-accelerated features, including texture mapping, Gouraud shading and Z-buffering.

Your Matrox graphics card is 100% VGA compatible and supports all VESA standards: VBE 2.0 (Super VGA modes), DPMS (energy saving), and DDC-2B (Plug-and-Play monitor).

Also, you can upgrade your Matrox card with hardware add-ons. For a list of available upgrades, see “[Hardware information](#)”, page 44. For more information on available upgrades, see the Matrox Web site (www.matrox.com/mga).

Hardware supplied

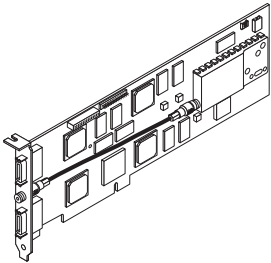

Productiva G100 MMS card*

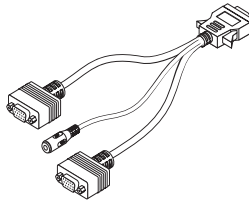

Dual-monitor adapter†

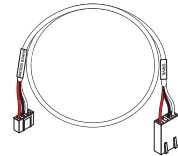

Internal audio cable‡

* Pictured is a G100-Quad card with a TV tuner.

† **Two** dual-monitor adapters are included with Matrox MMS-**Quad** products. An adapter with a composite video (RCA) connector is included only with Matrox MMS products that include a TV tuner.

‡ Matrox TV tuner required. Only certain Matrox MMS products include a TV tuner.

Software supplied

- **Matrox PowerDesk** – to use your Matrox graphics hardware
- **Matrox Video Tools***† – to use your Matrox video capture hardware
- Adobe Acrobat Reader for Windows
- Online documentation

Installation overview

To install your Matrox product:

- 1** Install the hardware – see “[Hardware installation](#)”, page 7.
- 2** Connect your video input – see “[Connection setup](#)”, page 11.
- 3** Install the software –
 - for Windows 98 and Windows NT 4.0, see “[Software installation](#)”, page 15.
 - for Windows NT 3.51, see the *readme* file in the root folder of the “Matrox Installation” CD-ROM.

* Matrox TV tuner required. Only certain Matrox MMS products include a TV tuner.

† Matrox Video Tools software isn’t supported for Windows NT 3.51.

Hardware installation

WARNING: Static electricity can severely damage electronic parts. Before touching any electronic parts, drain the static electricity from your body. You can do this by touching the metal frame of your computer. When handling a card, hold it by its edges, and avoid touching its circuitry.

1 Switch to the standard VGA display driver

If you're running Windows 98 on your computer, this step isn't necessary. If you're using another operating system (for example, Windows NT 4.0), see its documentation for how to switch to VGA mode.

2 Open your computer and remove your existing graphics card

- a Turn off your computer and all peripherals such as your monitor or printer.
- b Open the computer and remove your existing graphics card. (If you have a display adapter built into your computer motherboard, it should automatically disable itself after your Matrox card is installed.)

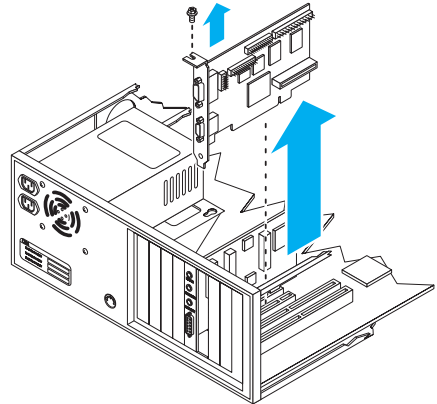

3 Choose an expansion slot

- a Most computers have different types of expansion slots. Choose a PCI slot for your graphics card. Your system manual should identify the location of each type of expansion slot in your computer.
- b Remove the cover for the slot you intend to use (if it's not already removed). Save the screw for the mounting bracket. (If another slot is uncovered, you can seal it with the cover you just removed.)

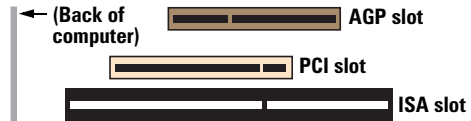

WARNING: Inserting your Matrox card into the wrong type of slot could damage your card, your computer, or both.

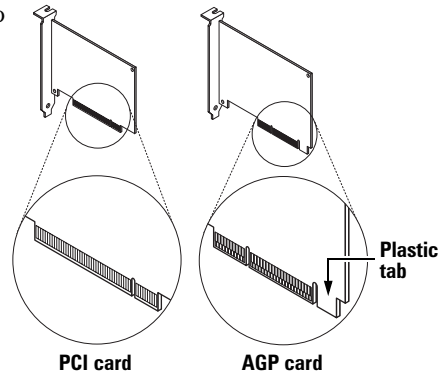

4 Insert your Matrox card

- a Position your Matrox card over the expansion slot you've chosen, then push the card in firmly and evenly until it's fully seated.
- b Replace the screw to secure the bracket of your Matrox card to the computer frame.

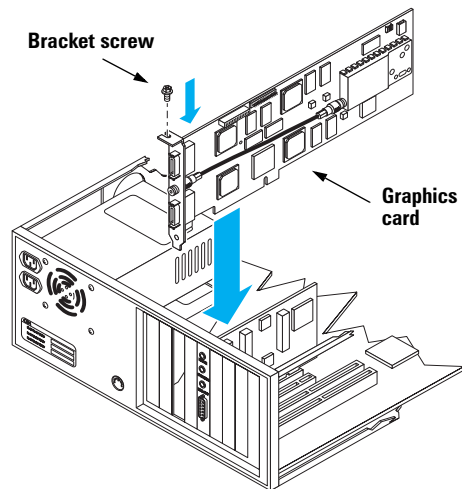

5 *If your Matrox product includes a TV tuner:*

Connect the internal audio cable

To use audio from your Matrox TV tuner, connect the internal audio cable included with your Matrox product.

- a** Note how your sound card is connected to your CD-ROM or DVD-ROM drive and then disconnect it from your drive.
- b** Plug the end of the cable from your sound card into the **AUDIO OUT** connector on your Matrox card.

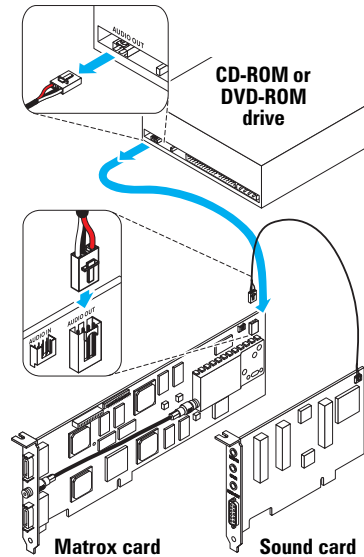

- c** Use the audio cable included with your Matrox product. Plug the end labeled **MATROX BOARD** into the **AUDIO IN** connector on your Matrox card.
- d** Plug the other end of the Matrox audio cable (labeled **DRIVE**) into the audio out connector on your CD-ROM or DVD-ROM drive.
- e** Put your computer cover back on.

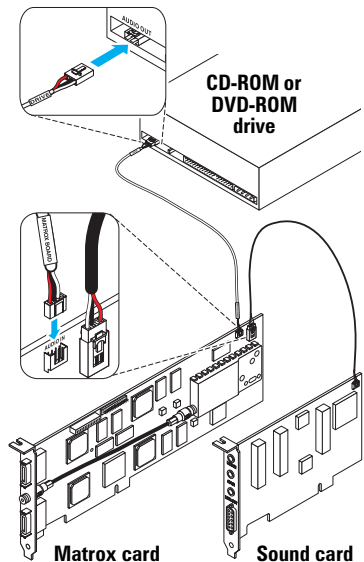

Note – If your sound card has a TV tuner connector or your computer doesn't have a CD-ROM or DVD-ROM drive: use the Matrox audio cable; plug the end labeled **DRIVE** into the **AUDIO OUT** connector on your Matrox card; plug the other end into your sound card using its TV tuner connector (if it exists) or its audio input connector.

6 Connect your monitors

- a Attach your Matrox dual-monitor adapters* to the connectors on the bracket of your Matrox MMS card. Make sure the adapters snap into place.

If you have an MMS-Quad card with a TV tuner, connect the dual-monitor adapter with the composite video (RCA) connector to the connector on the upper part of the bracket (#1/#2).

- b Plug your monitor cables into the dual-monitor adapters. Make sure the connectors are firmly in place. Monitors are numbered consecutively based on which connector each is attached to. Numbering starts with the *primary display* – the one that first displays information when you restart your computer.
- c Make sure the other end of each monitor cable is properly connected to its monitor. See your monitor manuals for more information.

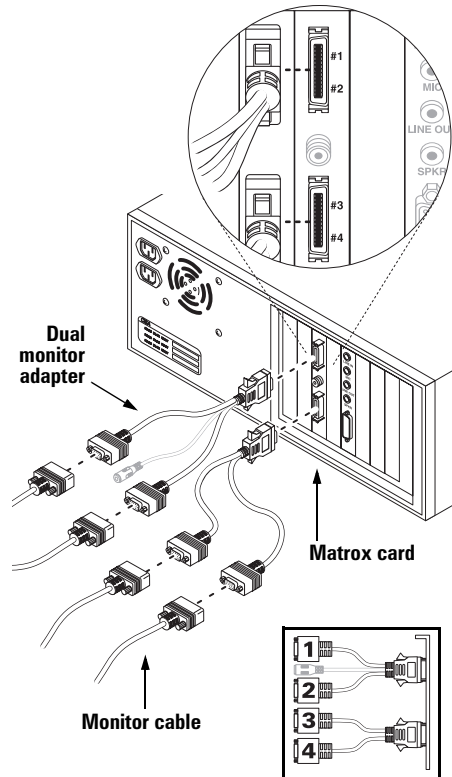

Your Matrox card is now installed. If your Matrox product includes a TV tuner, connect your external devices *before restarting your computer* (see “[Connection setup](#)”, page 11). *After connecting your external devices*, restart your computer and install your Matrox software (see “[Software installation](#)”, page 15).

* Only one dual-monitor adapter is included with Matrox MMS-*Dual* cards.

Connection setup

(Matrox TV tuner required)

This section is only for Matrox products that include a TV tuner.

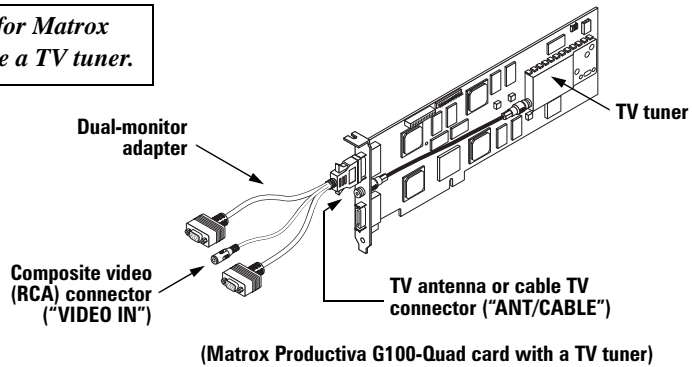

Quick connection setup

1 Connect video input

To use a video camera or video player* as a video source, you need a composite video (RCA) cable. This type of cable is available at most electronics stores.

- a** Plug one end of your video cable into the video connector on your dual-monitor adapter.
- b** Plug the other end into the **VIDEO OUT**[†] connector (usually yellow) on your video camera or video player.

For more information on video input devices, see “Matrox video input”, page 14.

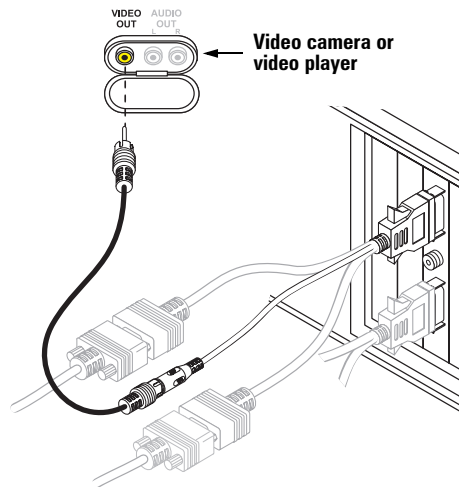

* A *video player* can be any device that generates a video signal. For example, a VCR, videodisc player or DVD player.

[†] The labels on your devices may not be consistent with what's in this guide. Different manufacturers sometimes use different labels for the same type of controls and connectors. For example, the **VIDEO IN** connector on your TV may be labeled **VIDEO 1** (or **VIDEO 2**). To match labels, see the documentation for your video devices.

SCART connectors: If your video camera or video player *only* uses a SCART audio/video connector (see picture), you may need to purchase a SCART adapter. For more information, see “SCART information”, page 13.

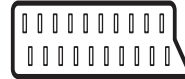

2 Connect audio input

To connect the audio output of your video camera or video player, you need an audio cable with a stereo jack on one end and two RCA connectors on the other end. This type of cable is available at most electronics stores.

- a Plug the stereo-jack end of the audio cable into the **LINE IN** connector on your sound card.
- b Plug the other end into left (L) and right (R) **AUDIO OUT** on the video device you connected to in [step 1](#). (On the audio cable, white is for “left” and red is for “right”. If your video device has only one audio connector, use the left audio connector on the cable.)

For more information on audio input types, see “Matrox video input”, page 14.

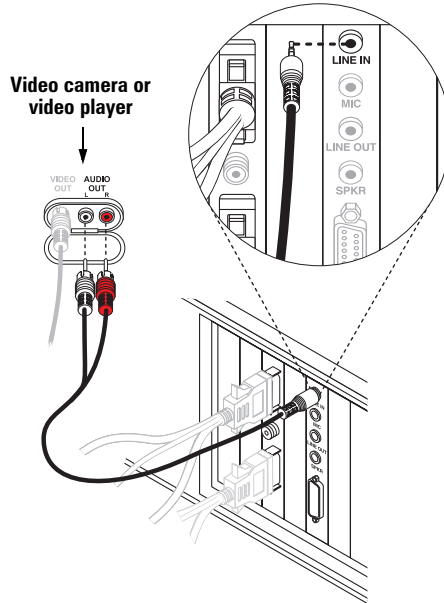

3 Connect TV antenna or cable TV

Connect a TV antenna or cable TV to **ANT/CABLE** on your Matrox product.

If the cable from your antenna is flat and ends with twin leads, you need a 300-to-75-ohm adapter to connect to the **ANT/CABLE** connector (see below). You can find this type of adapter at most electronics stores.

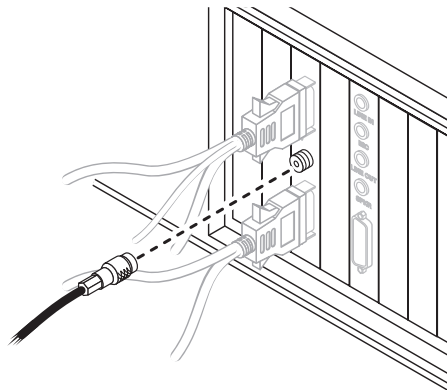
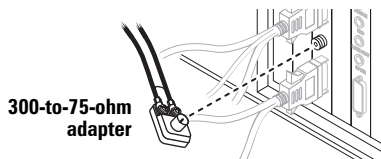

SCART information

Some video devices in Europe only have SCART connectors. This type of connector includes video *and* audio, whereas composite connectors include only video.

If your video camera or video player *only* has a SCART connector, you need a SCART cable adapter to connect to your graphics card. If you don't already have a SCART adapter, you should be able to purchase one from your local electronics store.

To connect your video camera or video player to Matrox *input*, you need a SCART adapter with **3 connectors** – 2 audio and 1 video.

To use a SCART adapter, connect your audio/video cables to the SCART adapter, then connect the adapter to your video camera or video player. Depending on the type of SCART adapter you're using, you may need *male-to-male* adapters to attach your audio/video cables to it. For more information on connecting to a video camera or video player, see steps [1](#) and [2](#) starting on page [11](#).

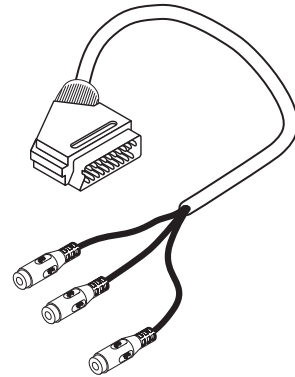

Composite SCART adapter with 3 connectors

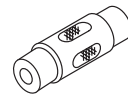

Male-to-male adapter (RCA)

Matrox video input

Copyright information: Unauthorized recording or use of broadcast television programming, video tape or other copyrighted material may violate copyright laws. Matrox assumes no responsibility for the illegal duplication, use or other acts which infringe on the rights of copyright owners. Your Matrox product may not let you record from a copy-protected video source.

Video player as input

If you connect the output of your video player to your computer, you can view, record and edit the video from your video player on your computer. To connect, see steps 1 and 2 starting on page 11. For more information, see your video player manual.

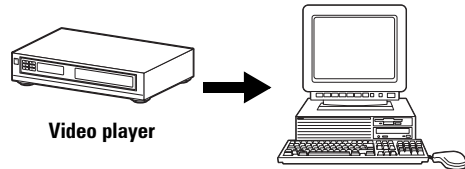

Video camera as input

If you connect a video camera to your computer, you can view, record and edit live video on your computer. You can also video conference. To connect, see steps 1 and 2 starting on page 11. For more information, see your video camera manual.

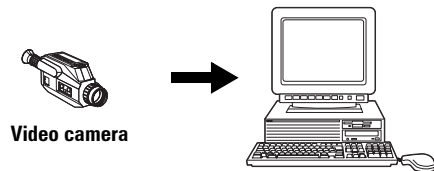

TV antenna or cable TV as input

You can connect a TV antenna or cable TV directly to your Matrox product. With this setup, you can use software to watch TV, change channels and record TV programs like a VCR*. To connect, see step 5, page 9, and step 3, page 12.

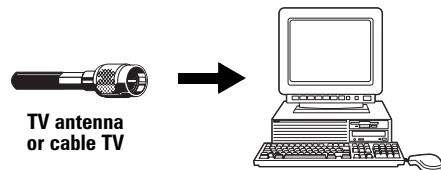

* You can also use a VCR as a TV tuner for your computer by connecting your TV antenna or cable TV to your VCR (see your VCR manual), and connecting your VCR to your computer.

Software installation

This section describes how to install Matrox software for *Windows 98* or *Windows NT 4.0*.

- 1 Restart your computer.

If you're using Windows 98, it detects new hardware when you restart. If Matrox display drivers haven't been previously installed, Windows reports finding a PCI adapter.

If you see the **Add New Hardware Wizard** dialog box, click **Next** → **Next** → **Next** → **Next** → **Finish**, then **Yes** to restart your computer.

At this point, Windows is using a display driver that doesn't fully support your Matrox graphics card.

- 2 *After* your computer has restarted, insert the “Matrox Installation” CD-ROM in your CD-ROM drive – the setup program automatically starts.* This setup program works with Windows 98 and Windows NT 4.0, and detects which operating system you're using. Follow the on-screen instructions.

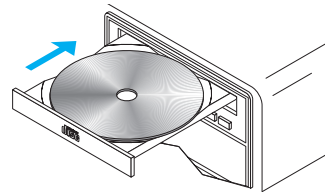

- 3 The setup program prompts you to restart your computer. Leave the CD-ROM in your CD-ROM drive and click **Restart Computer** to continue. After you restart your computer, the CD-ROM setup program starts again. The main menu lists other software you can install from the CD-ROM. To install, select an item, click **Install**, then follow the on-screen instructions. After the installation of an item is finished, you can return to the main menu to install another. Click **Exit** when you're done.

If this is a first-time installation, your display is using a 640 × 480 resolution with 256 colors – supported by most monitors. To adjust software monitor settings:

- for Windows NT 4.0, see “[Matrox PowerDesk software](#)”, page 16.
- for Windows 98, see Windows 98 online help under “Multiple Display support”.



Note: For more information on software included with your Matrox product, see the CD-ROM *readme* file.

* If Windows doesn't automatically start the setup program, you can start it manually from the root folder of the CD-ROM.

Matrox PowerDesk software

(for Windows NT 4.0)

Note: The Matrox display driver for Windows 98 supports multiple displays. However, Matrox PowerDesk features are disabled in multi-display mode. To change your display settings while in multi-display mode, use Windows controls. For more information on multi-display mode, see Windows 98 online help under “Multiple Display support”. Windows 95 doesn’t support multiple displays.

To access PowerDesk programs and online documentation, click  → **Programs** → **Matrox PowerDesk NT**. You can also access PowerDesk features by clicking the Matrox QuickDesk icon () on the Windows taskbar.

Monitor setup

To check your monitor settings

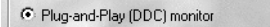
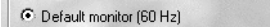
- 1 Click  → **Programs** → **Matrox PowerDesk NT** → **Matrox Display Properties** → **Monitor**.
- 2 In the **Current display** box, select the display you want to change monitor settings for. When you select a number, it appears briefly on the corresponding display.
- 3 **If you have a Plug-and-Play monitor:**
Make sure the **Plug-and-Play (DDC) monitor** button is selected. If so, the Matrox display driver *automatically* uses the correct settings for your monitor. If not, click this button, then click **Apply**.

- If you don’t have a Plug-and-Play monitor:**
See if the **Default monitor (60 Hz)** button is selected. If so, use the Matrox monitor selection method. For more information on Matrox monitor selection, see the online Matrox PowerDesk guide.

- 4 Repeat steps 2 and 3 for each number in the **Current display** box.

Note: In multi-display mode, each monitor has its own monitor settings.



Note: Many Plug-and-Play monitors don’t automatically report if they’re capable of 1152 × 864 or 1600 × 1200 and higher display resolutions. To use these resolutions, or higher refresh rates than those reported by the monitor, you can use the Matrox monitor selection method.

WARNING: If incorrect software monitor settings are applied, *some* monitors can be permanently damaged. For more information, see your monitor manual.

Display setup

After checking your monitor software settings, you can change your display resolution, color palette and other Matrox PowerDesk settings. To access Matrox display property sheets, click  → **Programs** → **Matrox PowerDesk NT** → **Matrox Display Properties**. To change your display resolution or color palette, click the **Settings** tab. For more information on changing your display settings, see the Matrox PowerDesk online guide.

Multi-display setup

To set up a multi-display resolution, click  → **Programs** → **Matrox PowerDesk NT** → **Matrox Display Properties** → **Settings** → **Multi-Display Desktop** (). Change the setup of your multi-display desktop by moving the **Desktop area** slider.

Note: In multi-display mode under Windows NT 4.0, the same display settings are used for each display.

Software overview

Matrox PowerDesk for Windows NT 4.0 includes

- Matrox display driver with:
 - Multi-display support to use up to 4 monitors at a time.
 - Plug-and-Play (DDC-2B) monitor support.
- **Settings** property sheet to change your display settings. This sheet provides access to Matrox PowerDesk features such as:
 - Desktop mode buttons to set up a proportional, horizontal or vertical *virtual desktop*.
 - Desktop mode button to set up a *multi-display* desktop.
 - Display schemes to easily switch to a pre-defined display setting.
- **Monitor** property sheet to inform the Matrox display driver of your monitor's capabilities.
- **Information** property sheet for information on your display hardware and software.
- **Performance** property sheet to configure advanced driver settings.
- **PowerDesk** property sheet with settings for:
 - **PixelTOUCH** to zoom in and pan on your view area.
 - **CenterWINDOW** to center opened windows in your view area.
 - **MaxVIEW** to maximize windows over the entire desktop or in a single display.

- **Center dialogs boxes** – to force dialog or message boxes to open in the center of program windows or in the center of a certain display.
 - **Open program windows in display** – to force program windows to open in a designated display.
 - **Use single display before logon** – to force single-display mode before you log on to Windows.
 - **Prevent display spanning** – to prevent dialog boxes, message boxes and program windows from spanning more than one display.
 - **Save/restore window positions** – to save and restore the size and position of program windows.
- **Matrox Desktop Navigator** (DeskNav) program to quickly change the view area of your desktop and give you quick access to the PixelTOUCH zoom and CenterWINDOW features.
 - **Matrox QuickDesk** menu to quickly switch to a saved display scheme, and to access other Matrox PowerDesk features.

Matrox PC-VCR Remote program

If your Matrox product includes a TV tuner, the Matrox PC-VCR Remote program lets you use your computer like you would a TV or VCR. To start, double-click the **PC-VCR Remote** icon (🖱️) on the Windows desktop background. The first time you start PC-VCR Remote, you see the PC-VCR Remote and its video window. Use the PC-VCR Remote to control what you see in the video window and what you record to file.

PC-VCR Remote interface

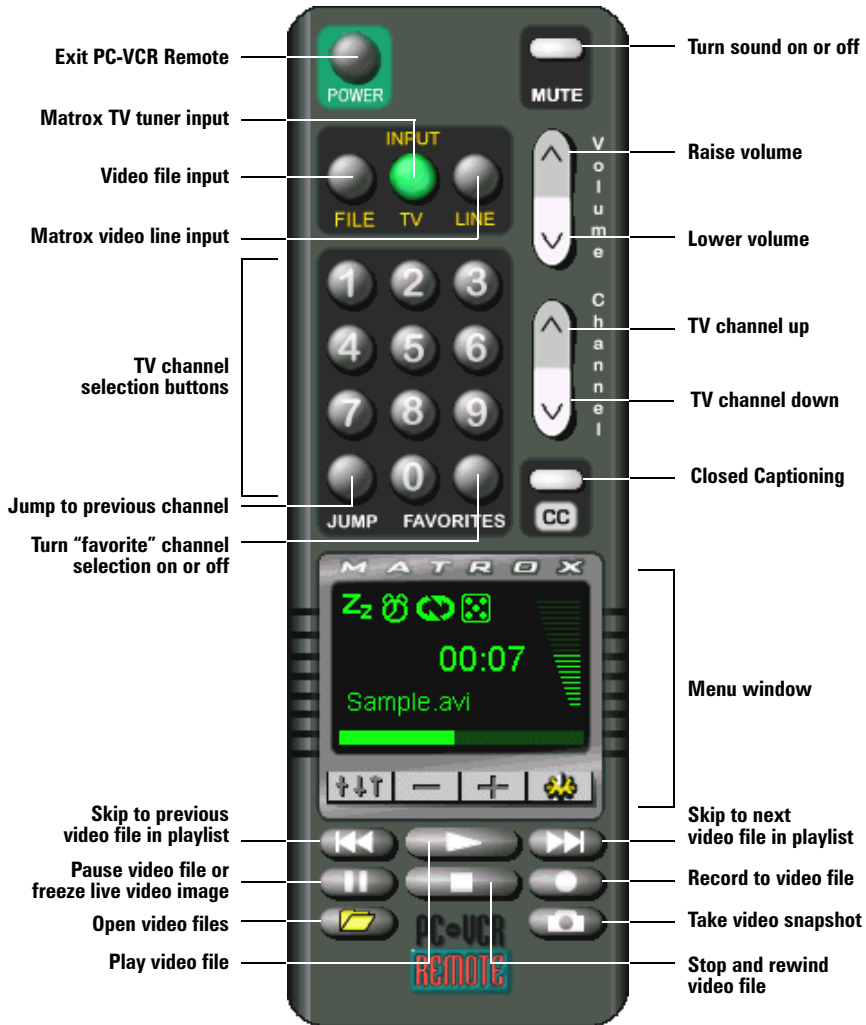

PC-VCR Remote menu window (with video file playback)

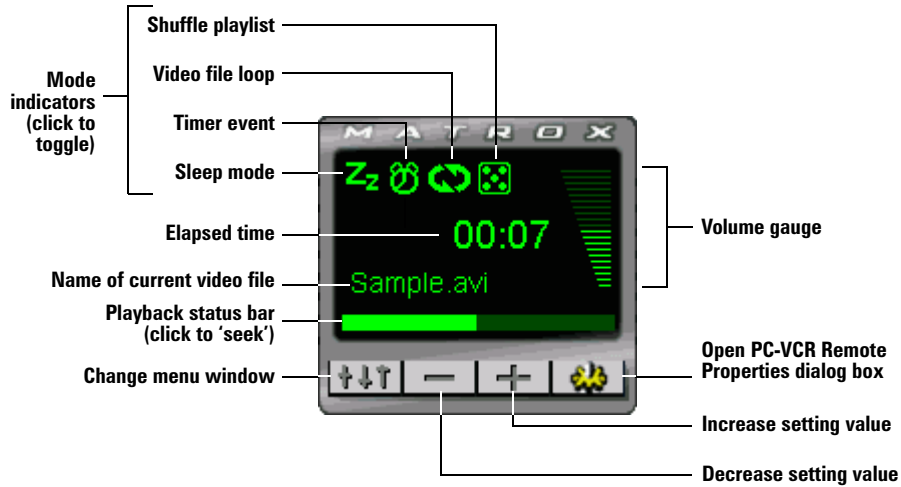

Input setting

After you've made sure your external video devices are properly connected, click an **INPUT** button on the PC-VCR Remote to select a video source for the video window.* This input setting affects many PC-VCR Remote controls. Select a button based on what kind of input you want to use:





- **FILE** – for video file playback.
- **TV** – to use your Matrox TV tuner.
- **LINE** – to use a device connected to your Matrox **VIDEO IN** connector. This can be a video camera or video player.

Video file input

With PC-VCR Remote, you can play AVI, MOV, MPG, MPS and DAT video files, including the video files you record with PC-VCR Remote (AVI files).

To view a video file

- 1 On the PC-VCR Remote, click the **FILE** button.
- 2 Click **Open Video Files** (), then select a video file in the resulting dialog box.
- 3 Click **Play** ().

* Depending on your graphics card and display settings, there are maximum video window resolutions (sizes). We recommend you use a 16-bit color palette setting for your display. For more information, see [page 43](#).

TV tuner input

You can view, record and edit TV programs on your computer, like you would with a VCR. However, instead of using the controls on your VCR, you can use the PC-VCR Remote software controls.

TV tuner software setup

To make sure PC-VCR Remote is set up to use your Matrox TV tuner:

- 1 Click the **TV** input button on the PC-VCR Remote.
- 2 Click the **Properties** () → **TV Setup**.
- 3 Click a **TV input** button to indicate what your Matrox TV tuner is connected to:
 - **Air** – for an antenna.
 - **Cable** – for cable TV.
- 4 Click **Advanced**, select the country you're in, then click **OK**.
- 5 Click the **Video** tab, then make sure the **Automatic** check box (in the **Input standard** group box) is enabled.
- 6 Click **TV Setup** tab → **Auto Scan** for PC-VCR Remote to automatically search all channels and keep in memory only the ones that can be tuned.
- 7 Adjust any other settings you want, then click **OK** to save settings and close the dialog box.

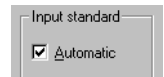
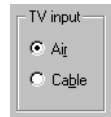

TV channel preview

To see the TV channel preview window, right-click the PC-VCR Remote, then click the **TV Preview** menu item. By resizing this window, you can preview up to 30 channels at a time. Use the scroll bar to preview different channels. If PC-VCR Remote **FAVORITES** feature is enabled, only the channels defined as your “favorites” are visible in the preview window.

The video window and the TV channel preview window can't be viewed at the same time. To view a particular channel in the video window and close the preview window, double-click a channel in the preview window.

Video line input

Note: Your Matrox product doesn't support S-video line input. Because of this, certain Matrox software controls are unavailable.

When the PC-VCR Remote **LINE** button is selected, the video window displays the signals coming from a device connected to your Matrox **VIDEO IN** connector. This can be a video camera or video player (see “Matrox video input”, page 14).

You can record from your video camera or video player to a digital video file. You can then play back this video file with PC-VCR Remote, or edit it with another program.

Before you record to a video file

- Make sure the video camera or video player is properly connected to your Matrox **VIDEO IN** connector. For more information on how to connect video devices, see steps 1–3, starting on page 11.
- Make sure your Windows sound card settings are correct. For more information, see “Sound”, page 40.

- Make sure your PC-VCR Remote property settings are correct. Click the **Properties** button () on the PC-VCR Remote to access its setting controls:

- On the **Video** property sheet, select the TV standard your video camera or video player uses (NTSC in North America; PAL in most of Europe; or SECAM in France). For PC-VCR Remote to automatically detect the TV standard, enable the **Automatic** check box. If this check box is enabled, there may be a delay of a few seconds when you change the **INPUT** setting.
- On the **Recording** property sheet, select the path where you want to save your video file and select your video capture options for PC-VCR Remote. Move the **Recording settings** slider to increase or decrease the frame size and rate of recordings. The higher the frame size, the higher the video quality, but also the more disk space you'll need.

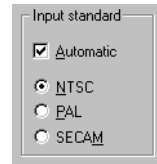

Look at the **Max recording time** box to see the maximum amount of time you can record to a video file. This time is based on the currently selected capture settings and the amount of free space on the disk where your video file will be recorded.

Recording settings

The maximum frame size and rates you can select with the **Recording settings** slider are based on the currently selected capture settings and the disk where the video file will be created. Higher-quality capture settings generally require a disk that can store information faster. PC-VCR Remote determines how fast your disk can store information by checking the results saved by the **Matrox HD Benchmark** program.

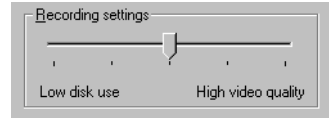

Note: Your Matrox product doesn't support hardware-accelerated MJPEG encoding and decoding. Because of this, certain Matrox software controls are unavailable.

For more information on PC-VCR Remote property settings, click “” on the title bar of the dialog box, then click a dialog box item.

Recording to a video file

- 1 Click the **LINE** button on the PC-VCR Remote. You should see video in the PC-VCR Remote video window; if not, see “[Before you record to a video file](#)”, page 22.
- 2 Click **Record** ().

If you click **Record** once, PC-VCR Remote will record to video file until you click **Stop** () or run out of disk space. If you click **Record** again, PC-VCR Remote will record for 2 minutes; click again and PC-VCR Remote will record for 4 minutes; and so on.

Mini remote

If you don't want to use the full-sized PC-VCR Remote, you can use the “mini remote”. The mini remote is a toolbar added to the PC-VCR Remote video window. The mini remote replaces the “full remote”. To use the mini remote, right-click the PC-VCR Remote, then click **Use Mini Remote** on the resulting pop-up menu.



Pause your mouse pointer over each mini remote button to see a pop-up tooltip identifying it. There are different buttons on the mini remote depending on the type of input selected.

To return to using the full remote again, right-click the PC-VCR Remote video window, then click **Use Full Remote** on the resulting pop-up menu.

More features

To access more features, click the **Properties** button () on the PC-VCR Remote. You can also right-click PC-VCR Remote or its video window to quickly access some features. Here's a partial list of what else you can do with PC-VCR Remote:

Full-screen video window Double-click the PC-VCR Remote video window to make its video image fill your entire computer display.* Double-click again to restore the video window to its original size.

TV program timer () You can program the PC-VCR Remote like you would a VCR. You can schedule weekly, daily or one-time-only TV program events which do one of three things:

- Make the PC-VCR Remote video window appear.
- Save Closed Captioning text to a file (North America only).
- Record video and audio input to a file.

Closed Captioning () Save Closed Captioning text to a file. If the current PC-VCR Remote video input signal supports the Closed Captioning service used in North America, click the **Closed Captioning** button to show or hide text information encoded in the video signal. (This feature doesn't work with the Teletext service used in Europe.)



Keyword detection Create lists of words that PC-VCR Remote automatically searches for in the Closed Captioning information of a video signal. Depending on how you set it up, PC-VCR Remote will make the video window appear, save Closed Captioning text to a file, or record the video and audio input to a file when it finds a keyword. (This feature doesn't work with the Teletext service used in Europe.)

Sleep mode () Have PC-VCR Remote close automatically after a certain amount of time.

Shuffle playlist () Shuffle the video files in the current playlist into random order. (To use this feature, enable **Use Playlist** first.)

Loop video files () Play video files continuously.

Video snapshots Click the **Video Snapshot** button () on the PC-VCR Remote to save a digital still image (“frame capture”) of the current PC-VCR Remote video window. Video snapshots can be saved as bitmap (*.bmp) or JPEG (*.jpg) files. You can adjust the quality, and as a result the file size of JPEG video snapshots.

* If your display area setting is too large, **TV** and **LINE** input and playback from AVI files may appear blocky when viewed full-screen because of the way the video is encoded.

Video window cropping If the PC-VCR Remote **LINE** or **TV** button is selected, hold down the [Shift] key, then click the video window display area. This opens a dialog box that lets you trim the edges of the video window display. This is useful for hiding information along the edges of a video image or if you just want to see part of your video window display. You can also hold down the [Ctrl] key, then drag in the video window to crop. To restore cropping settings, right-click the video window, then click the **Reset Cropping** menu item.







Note: In a video window with no cropping, the edges of video images may appear distorted. You normally don't see this distortion on a TV because most TVs crop the edges of video images. Professional video equipment doesn't produce this distortion but consumer-quality video equipment may. You can use the cropping feature of PC-VCR Remote to hide this distortion.

Hot keys Assign keyboard shortcuts to many PC-VCR Remote controls.

Audio With a sound card installed in your computer, you can adjust your computer sound output with the PC-VCR Remote.

TV tuner With the TV tuner built into your graphics card, you can:

- Simultaneously preview up to 30 channels in a single window.
- Change channels with PC-VCR Remote controls.
- Schedule TV program timer events for different channels.
- Password-protect certain TV channels (“parental lock”).
- Auto Scan for tunable TV channels.
- Define certain channels as your favorites and quickly skip to those channels with the PC-VCR Remote channel up and down buttons.

To turn some features on or off, click the PC-VCR Remote mode indicators (, , , , ) . For more information on PC-VCR Remote features and controls, see its context-sensitive help. Click “” on the title bar of a dialog box, then click a dialog box item.

Matrox VidCap driver

If your Matrox product includes a TV tuner, video capture programs (*other than* Matrox PC-VCR Remote) use the Matrox **VidCap** driver interface. For example, you use the Matrox VidCap driver to adjust settings in a video conferencing program. This section describes VidCap source and format setting controls.

Video source settings

Video channel – Click a button in this group box to select a source:

Note: Your Matrox product doesn't support S-video line input. Because of this, certain Matrox software controls are unavailable.

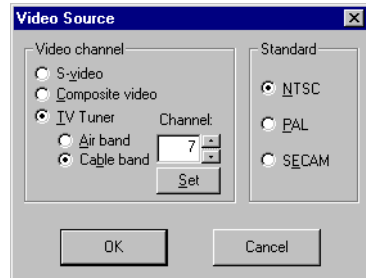

Composite video – to capture video from a video camera or video player connected to your Matrox **VIDEO IN** connector.

TV tuner – to capture video from your Matrox TV tuner.

Depending on what's connected to your Matrox **ANT/CABLE** connector, click one of these buttons:

- **Air band** – for a TV antenna.
- **Cable band** – for cable TV.

With the **Channel** box, select the channel you want to use. Click **Set** to apply your selection.

For more information, see [“Hardware installation”, page 7](#).

Standard – Click a button in this group box to identify the TV standard used by your video source:

NTSC – for most North American video devices.

PAL – for most European video devices.

SECAM – for video devices using the TV video standard from France.

The VidCap driver automatically assigns the correct standard used by your current video source. VidCap won't let you select a TV standard it doesn't detect.

Video format settings

RGB – Select a video file format. The bit values represent how many bits of information are used for color palette information; the larger the bit value, the more colors can be used, but the larger the file size.

8-bit – 256 shades of gray

16-bit – 65,536 colors

24-bit – 16,777,216 colors

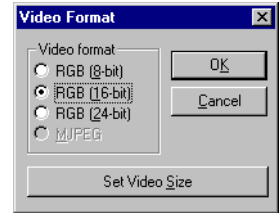

Note: Your Matrox product doesn't support hardware-accelerated MJPEG encoding and decoding. Because of this, certain Matrox software controls are unavailable.

Set Video Size – Click this button to adjust the video image size (resolution) settings for the currently selected format. The data rate estimate *doesn't* take audio into account.

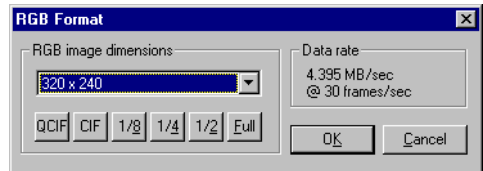

Overlay and preview modes

The video capture program you're using may give you a choice of *overlay* or *preview* modes. Overlay and preview settings affect how video is viewed or captured:

- With overlay mode, everything *on* the video window is captured. For example, any part of a dialog box overlapping the video window appears in the captured video.
- With preview mode, you will get a lower frame rate (resulting in jerky video) and you may not be able to view or capture video if there isn't enough graphics memory available. The amount of graphics memory available depends on how much memory is on your graphics card, the size of the video window, and the resolution and color palette settings of your display.

Troubleshooting

Graphics

The following troubleshooting items address problems related to graphics cards.

For a list of notes, problems and limitations, click  **Start** → **Programs** → **Matrox PowerDesk** → **Readme**. Also, be sure to check for any last-minute release notes at the end of this manual and in the Matrox CD-ROM *readme* file.

Problem **Computer doesn't boot or display information after Matrox card is installed**

Cause Your Matrox card may not be properly installed.

Solution Make sure your Matrox card is properly installed. Specifically, make sure the card is firmly inserted in its expansion slot and that all connections to it are firmly in place. For more information, see [“Hardware installation”](#), page 7.

Cause There may be an unsupported graphics adapter in your computer.

Solution If an unsupported graphics card is plugged into an expansion slot, remove it.

Solution If a graphics adapter is built-in to your computer motherboard, your system may not have automatically disabled it when you inserted your Matrox card. Check your system manual for instructions on how to disable your computer built-in graphics adapter.

Cause Your computer BIOS (Basic Input/Output System) may not be up to date. For more information on your computer BIOS, see your system manual.

Solution Reinstall your previous graphics card and, if possible, update your computer BIOS. This can usually be done with software from the manufacturer of your computer. Contact your system vendor or manufacturer to get a BIOS update for your computer.

To get the correct BIOS update, you may need to know the serial number your computer displays when it restarts. (This number is usually in the lower-left corner of the display.)

Cause The BIOS of your Matrox graphics card may need to be updated or restored.

Solution **For advanced users:** If you have another VGA-compatible graphics card (ISA or PCI), you can try resetting the BIOS of your Matrox graphics card:

- 1 Turn off your computer and insert the other graphics card into an expansion slot. For more information on expansion slots, see “Choose an expansion slot”, page 8.
- 2 Plug your monitor into the other graphics card and restart your computer.

Note: If you’re using more than one PCI graphics card, make sure the other graphics card is used for your *primary display* – the one that first displays information when you restart your computer. If not, turn off your computer, move the other card to another PCI slot, then try restarting your computer again.

- 3 Make sure Matrox DOS utilities are installed on your computer. (These can be installed from your Matrox CD-ROM.)
- 4 Restart your computer in DOS mode, then type:

```
cd c:\mga\setup [Enter]  
updbios [Enter]
```
- 5 Turn off your computer, remove the other graphics card, then plug your monitor into your Matrox graphics card.
- 6 Restart your computer.

Problem **Wrong color balance, screen image off-center, or no picture at all**

Cause Your monitor video controls may be improperly set.

Solution Adjust your monitor controls (brightness, contrast and so on). For more information, see your monitor manual.

Cause Your monitor may not be properly connected.

Solution Make sure the monitor power cable is firmly in place.

Solution Make sure the 15-pin connector to the dual-monitor adapter is firmly in place.

Solution If your monitor uses a 15-pin connector, make sure the connection to the monitor is firmly in place.

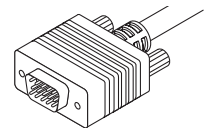

15-pin connector

Solution Make sure your Matrox dual-monitor adapter is properly connected. For more information, see “Connect your monitors”, page 10.

Solution If your monitor uses BNC input, make sure the Red, Green, Blue, Horizontal Sync (HSYNC – white or gray wire), and Vertical Sync (VSYNC – black wire) connections are firmly in place and plugged into the correct input.

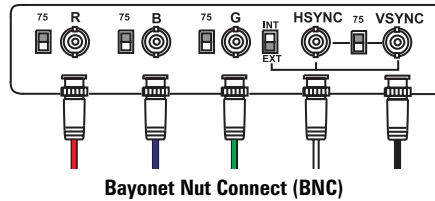

Cause If your monitor uses BNC input, one or more connection settings may be incorrect.

Solution Set each of your monitor RGB input and sync switches (if available) to 75 ohms, with the sync set to “external”. These controls are usually switches on the back of your monitor.

Problem **After the startup screen, or after display settings are changed, the screen image is garbled or unusable**
(rolling or overlapping screen images or a blank screen)

Cause The Matrox display driver may be trying to use settings your monitor doesn’t support. This can happen if a monitor was never selected in the software and the display resolution was changed to one your monitor doesn’t support, or if the monitor connected to your computer was changed without it being changed in the software.

WARNING: If incorrect software monitor settings are applied, *some* monitors can be permanently damaged. For more information, see your monitor manual.

Solution **Windows NT 4.0** (if your primary display is usable):

- 1 Click  → **Programs** → **Matrox PowerDesk NT** → **Matrox Display Properties** → **Settings**.
- 2 Move the **Display area** slider down to its lowest setting, then click **OK**.
- 3 With the Matrox **Monitor** property sheet, select monitor settings for each display, then adjust your display settings. For more information, see the online Matrox PowerDesk guide.

Solution **Windows NT 4.0** (if your primary display is unusable):

- 1 Press [Ctrl]+[Alt]+[Del] → [Tab] → [Tab] → [Enter] → [↓] (down arrow) → [Enter] to restart your computer.
- 2 From the startup menu, choose Windows NT 4.0 “**VGA mode**”.

- 3 Right-click the Windows desktop background, then click **Properties** → **Settings**.

Windows may prompt you that the display settings are incorrect for the current mode; click **OK** to continue.

- 4 Move the **Desktop area** slider down to its lowest setting, then click **OK**.
- 5 Restart your computer normally.
- 6 With the Matrox **Monitor** property sheet, select monitor settings for each display, then adjust your display settings. For more information, see the online Matrox PowerDesk guide.

Solution **Windows 98** (if your primary display is usable):

- 1 Right-click the Windows desktop background, then click **Properties** → **Settings**.
- 2 In the desktop preview area, right-click the display you want to configure, then click **Properties** → **Monitor** → **Change**.
- 3 From the monitor list, select the monitor model for the display you selected. (For more information on monitor selection, see Windows online help.)
- 4 Click **OK** → **OK** → **OK**.
- 5 Repeat steps 1–4 for each monitor connected to your computer.

Solution **Windows 98** (if your primary display is unusable):

- 1 Press [Ctrl]+[Alt]+[Del] twice to restart your computer.
- 2 *Before Windows starts*, press [F5] to enter “safe mode”.
- 3 Right-click the Windows desktop background, then click **Properties** → **Settings**.
- 4 Move the **Desktop area** slider down to its lowest setting, then click **OK**.
- 5 Restart your computer normally.
- 6 With the Microsoft **Monitor** property sheet, select monitor settings for each display, then adjust your display settings. For more information on monitor selection, see Windows online help.

Problem **Built-in network card doesn't work after multi-monitor graphics card is installed**

Cause The installation of a multi-monitor graphics card may have caused your computer to reallocate system resources.

Solution Try reinstalling your network drivers.

Solution Try moving your Matrox multi-monitor graphics card to another PCI slot in your computer.

Problem Matrox Diagnostic or setup program reports an IRQ problem (3D and video programs don't work)

Cause Your computer or program may not work well with bus mastering.

Solution Disable bus mastering.
(If you want to continue using bus mastering, see the other solutions.)

Windows NT 4.0:

- 1 Click  → **Programs** → **Matrox PowerDesk NT** → **Matrox Display Properties** → **Performance**.
- 2 Clear the **Use Bus Mastering** check box.
- 3 Click **OK** → **Yes** to accept the changes and restart your computer.

Windows 98:

- 1 Disable Windows 98 multi-display mode (see page 35).
- 2 Click  → **Programs** → **Matrox PowerDesk** → **Matrox Display Properties** → **Settings** → **Advanced** → **Performance**.
- 3 Clear the **Use Bus Mastering** check box.
- 4 Click **OK** → **OK** → **Yes** to accept the changes.
- 5 Re-enable Windows 98 multi-display mode (see page 35), then restart your computer.

Cause Your Matrox card may be in a “slave” expansion slot on a computer that makes a distinction between bus mastering and slave slots.

Solution Change slots: Shut down your computer, disconnect it from the power supply, remove your Matrox card and then insert it into a different PCI expansion slot. For instructions on how to safely install your Matrox card, see “[Hardware installation](#)”, page 7.

Cause Your computer may not have given an IRQ (interrupt request) to your Matrox graphics card or may have given one used by another device in your computer. This may be because your computer’s “Plug-and-Play” feature is turned off.

Windows 98 – To check the display adapter’s IRQ:

- 1 Right-click the **My Computer** icon on the Windows desktop background, then click **Properties** → **Device Manager**.
- 2 Click the plus sign to the left of the **Display adapters**. An “X” through an icon means the hardware has been disabled. A circled exclamation point through the icon means the hardware has a problem.
- 3 Double-click the name of your Matrox display adapter to open a properties dialog box. The type of problem is displayed in the **General** tab → **Device status** area. Check also the **Resources** tab → **Resource settings** list for an **Interrupt Request**.

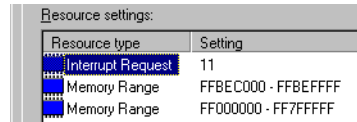

Resource type	Setting
Interrupt Request	11
Memory Range	FFBEC000 - FFBEFFFF
Memory Range	FF000000 - FF7FFFFF

Solution Change settings in your computer CMOS setup utility.

If your computer has the options of enabling Plug-and-Play detection, or assigning an IRQ to a VGA adapter, make sure they’re enabled. If your computer doesn’t have these options, you may be able to manually assign an IRQ to your graphics card using the CMOS setup utility.

For more information on your computer CMOS setup utility, see your system manual or contact your system manufacturer.

Solution **Windows 98:** You may have to manually assign an IRQ to your Matrox card with the *irqset* program in the *C:\Program Files\Matrox MGA PowerDesk* folder. For instructions on how to use *irqset*, click  → **Programs** → **Matrox PowerDesk** → **Readme**.

Cause Your computer’s other BIOS settings may be incorrect.

Solution Reset your computer BIOS settings to the factory defaults using your computer built-in CMOS setup utility. The factory defaults are usually the “safest” settings. Check your system manual for more information.

Problem Screen image defects appear in Windows 98 or Windows NT 4.0, or program doesn't run properly

(example: mouse pointer not drawn properly)

Cause Some programs may not work properly with some Matrox acceleration.

Solution Try disabling specific types of acceleration.

Windows NT 4.0:

- 1 Click  → **Programs** → **Matrox PowerDesk NT** → **Matrox Display Properties** → **Performance**.
- 2 Clear one or more check boxes.
For more information, see context-sensitive help.
- 3 Click **OK** → **Yes** to accept the changes. (Depending on the feature you disabled, you may have to restart your computer for the changes to take effect.)

Windows 98:

- 1 Disable Windows 98 multi-display mode (see page 35).
- 2 Click  → **Programs** → **Matrox PowerDesk** → **Matrox Display Properties** → **Settings** → **Advanced** → **Performance**.
- 3 Clear one or more check boxes, starting with **Use Device Bitmaps Caching**.
For more information, see context-sensitive help.
- 4 Click **OK** → **Close** to accept the changes. (Depending on the feature you disabled, you may have to restart your computer for the changes to take effect.)
- 5 Re-enable Windows 98 multi-display mode (see page 35), then restart your computer.

Solution If possible, update your Matrox display driver. Matrox makes new display drivers available on the Matrox Web site (www.matrox.com/mga) and BBS (see page 46).

Solution **Windows 98:** Disable Matrox hardware acceleration.

- 1 Right-click the **My Computer** icon on the Windows desktop background.
- 2 Click **Properties** → **Performance** → **Graphics**.
- 3 Move the **Hardware acceleration** slider to **None**.
- 4 Click **OK** → **Close** → **Yes** to accept the changes and restart your computer.

Cause **Windows 98:** There may be a conflict between resources in your system.

Solution

- 1 Right-click the **My Computer** icon on the Windows desktop background, then click **Properties** → **Device Manager**.
- 2 Click the plus sign next to **Other devices** (if it appears) and **Display adapters**.

- 3 Delete any display adapter *other than* the one for your Matrox graphics card.
- 4 Restart your computer.

Note: If you identify a program that doesn't work well with Matrox acceleration, please contact Matrox technical support (see page 46) and describe the problem. This information may help us come up with a fix or work-around in a future driver release.

Problem **PowerDesk controls can't be accessed in Windows 98**

Cause Matrox PowerDesk is disabled in multi-display mode in Windows 98.

Solution To access PowerDesk controls, you can disable multi-display mode:

- 1 Right-click the **My Computer** icon on the Windows desktop background, then click **Properties** → **Device Manager**.
- 2 Click the plus sign to the left of the **Display adapters**.
- 3 Double-click the name of a Matrox display adapter to open a properties dialog box.
Enable the **Disable in this hardware profile** check box, then click **OK**.

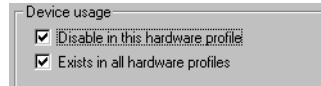

Note: Your primary display can't be disabled.

- 4 Repeat step 3 until all display adapters are disabled, *except* the one for your primary display.
- 5 Click **Close** → **Yes**.
- 6 Restart your computer for changes to take effect.

Note: To restore multi-display mode, repeat steps 1–6, but clear the **Disable in this hardware profile** check box in step 3.

Video

The following troubleshooting items address problems related to the TV tuner and to video input.

For a list of notes, problems and limitations, click  **Start** → **Programs** → **Matrox Video Tools** → **Read Me**.

Problem **Can't use a video program**

(video capture, playback, editing or conferencing programs)

Cause Files may be missing or corrupted.

Solution **Windows 98 or NT 4.0:** Uninstall then reinstall Matrox video software. To uninstall, click  **Start** → **Settings** → **Control Panel** → **Add/Remove Programs** (double-click) → **Matrox Video Tools** → **Add/Remove** → **Yes**. To reinstall, insert the “Matrox Installation” CD-ROM in your CD-ROM drive – the setup program automatically starts. (If Windows doesn't automatically start the setup program, you can start it manually from the root folder of the CD-ROM.)

Solution Uninstall then reinstall the program you're having problems with. For more information, see its documentation.

Problem **Can't record video from a video player**

Cause The video source may be copy protected. Your Matrox product doesn't let you make copies of copy-protected video. (Some video sources let you make a copy of a video, but you may not be able to make a copy of that copy.)

Solution To get copies of a copy-protected video, contact the vendor of the video.

Problem **No picture in PC-VCR Remote video window**

Cause One or more of your cable connections may be loose or incorrect.

Solution Make sure all your computer connections are firmly plugged in.

Solution Make sure connections are correct (see “[Connection setup](#)”, page 11).

Solution Make sure the PC-VCR Remote input settings are correct (see “[Matrox PC-VCR Remote program](#)”, page 19).

Cause PC-VCR Remote video tuning settings may be set too low.

Solution Reset the video tuning settings to default values: On the PC-VCR Remote, click **Properties** () → **Video** → **Default Tuning** → **OK**.

Problem Video file playback is jerky (skipping frames)

Cause Your hard disk may be too slow.

Solution **Windows 98:** Try recapturing and playing back video files after defragmenting your hard disk. Click  → **Programs** → **Accessories** → **System Tools** → **Disk Defragmenter**.

If Disk Defragmenter isn't installed:

- 1 Click  → **Settings** → **Control Panel**.
- 2 Double-click the **Add/Remove Programs** icon.
- 3 Click the **Windows Setup** tab.
- 4 Double-click the **Disk Tools** list item.
- 5 Enable the **Disk Defragmenter** check box.
- 6 Click **OK** → **OK**. (You may be prompted to insert the Windows CD-ROM in your CD-ROM drive.)

Solution **Windows 98:** If your hard disk supports DMA transfers, enable this feature, then try recapturing and playing back video files. To enable DMA for a hard disk:

- 1 Right-click the **My Computer** icon on your Windows desktop background, then click **Properties** → **Device Manager**.
- 2 Double-click the **Disk drives** list item to expand it, then double-click the name of the hard disk you're using.
- 3 Click **Settings**, then enable the **DMA** check box.
- 4 Click **OK** → **OK** → **Yes** to restart your computer and for changes to take effect.

Note: Not all hard disks support DMA well. For more information, see the documentation that came with your hard disk.

Solution If possible, try recapturing and playing back video files with a faster disk. To test and compare disk speeds, click  **Start** → **Programs** → **Matrox Video Tools** → **Matrox HD Benchmark**.

Tip: If your computer has more than one hard disk, you may get better results if you play back or capture video files with a disk *other than* the one where the Windows swap file is stored. (The Windows swap file is usually stored on drive “C:”.)

Solution If possible, recapture the video file using settings that require less disk use. For more information, see “Before you record to a video file”, page 22.

Cause If you’re using the PC-VCR program for video file playback, tooltips may be interfering with its video window display.

Solution For PC-VCR Remote, disable tooltips:

- 1 On the PC-VCR Remote, click **Properties** () → **General**.
- 2 Clear the **Use tooltips** check box.
- 3 Click **OK** to apply changes and close the dialog box.

Solution For other programs, avoid pausing your mouse pointer over controls.

Cause Too many programs may be running (using up computer resources).

Solution Close other programs, including memory resident programs like **System Agent**.

Cause Your Matrox graphics card may be sharing an IRQ (interrupt request) with another PCI card in your computer (for example, a network card).

Windows 98 – To see if your graphics card is sharing an IRQ:

- 1 Right-click the **My Computer** icon on your Windows desktop background, then click **Properties** → **Device Manager** → **Properties**.
- 2 Look in the list box to see if your Matrox graphics card is assigned the same IRQ number as another PCI card in your computer.

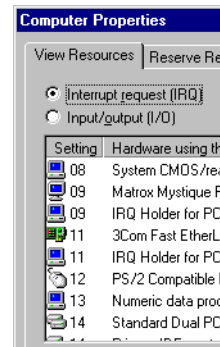

Solution Try moving the other PCI card to another PCI slot in your computer. For more information, see the documentation for this card or see your system manual.

Solution Try moving your Matrox graphics card to another PCI slot in your computer.

Solution Windows 98: Use the *irqset* program to manually assign a different IRQ number to your Matrox graphics card. For instructions on how to use *irqset*, click  → **Programs** → **Matrox PowerDesk** → **Readme**.

Problem Poor video capture quality

Cause The settings a video file was created with may not be optimal.

Solution If possible, recreate the video file with more optimal settings. If you're using PC-VCR Remote, see [“Before you record to a video file”](#), page 22.

Cause There may be too many video devices between your video source and destination, or one or more of the video devices may be degrading the quality of the video signal. Demodulators, long cables, cable extensions and improper connections can all affect video signal quality.

Solution Try changing one or more video devices.

Solution If possible, try using fewer connections. For example, don't use cable extensions.

Problem Mouse pointer flickers or disappears when it's over a video window

Cause You may be using a customized mouse pointer. Windows draws customized mouse pointers in a way that may cause them to flicker or disappear while they're over a video window.

Solution Use default Windows mouse pointers.

Windows 98 or NT 4.0:

- 1 Click the  → **Settings** → **Control Panel**.
- 2 Double-click the **Mouse** icon, then click the **Pointers** tab.
- 3 In the **Scheme** box, select (or reselect) **“(None)”**, then click **OK**.

Problem PC-VCR Remote reports that it doesn't detect the TV tuner or there's no TV in the video window when 'TV' input is selected

Cause The video signal coming from your antenna or cable TV may have problems. To test it, temporarily connect it directly to a TV. (If it works okay with your TV, it should work for your Matrox TV tuner.)

Solution Make sure your antenna or cable TV connection to your TV tuner is okay. See [“Connect TV antenna or cable TV”](#), page 12.

Solution If you're using an antenna, try adjusting it, checking all the connections to it, or using a different antenna.

Solution If you're using cable TV, contact your cable company.

Cause Software settings may be incorrect.

Solution See “Matrox PC-VCR Remote program”, page 19.

Sound

The following troubleshooting items address problems related to sound cards.

Problem **Sound doesn't record, video files play back with no sound, or sound output is distorted or too loud**

Cause If the sound problem is with a particular device (for example, TV or speaker), the volume control on the device itself may need adjusting.

Solution Adjust the volume control on the device itself.

Cause Audio cables may be loose or incorrectly wired.

Solution Make sure your sound card cables are properly connected (see [step 5, page 9](#), and [step 2, page 12](#)).

Cause Your sound card's Windows software settings may be incorrect. Specifically, input or output may be disabled, or volume levels may be too low or too high.

Solution **Windows 98 or NT 4.0:** Make sure your sound card's Windows software settings are correct:

1 Double-click the speaker icon () on the Windows taskbar.

If you *don't* see the speaker icon:

a Click  → **Settings** → **Control Panel**.

b Double-click the **Multimedia** icon.

c Enable the “**Show volume control on the taskbar**” check box.

d Click **OK**.

e Double-click the speaker icon on the taskbar.

2 Click **Options** → **Properties**.

3 Click the **Recording** button, enable all check boxes in the list box, then click **OK**.

- 4 For the **Line-In** and/or **Microphone** controls, make sure the **Volume** slider levels are okay (if you're not sure, try half level), and the **Select** check boxes are enabled.

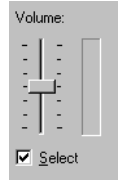

Note: To access the recording settings of your sound card with Matrox PC-VCR Remote, click **Properties** () → **Recording** → **Audio Levels**.

- 5 Click **Options** → **Properties**.
- 6 Click the **Playback** button, enable all check boxes in the list box, then click **OK**.
- 7 For the **Master**, **Line** and/or **Wave** controls, make sure the **Volume** sliders are at one-quarter to one-half levels (if you're not sure, try half level), and the **Mute** check boxes are cleared.
- 8 Close the dialog box.

Cause The problem may be specific to the sound card you have.

Solution For more information, see your sound card manual.

Display information

Graphics

Maximum display resolutions (for each display)

Graphics memory	Color palette	Maximum display area	Maximum 3D display area*
4 MB	256 colors (8-bit)	1800 × 1440 / 1920 × 1200	—
	32/64 K colors (15/16-bit)	1600 × 1200 / 1920 × 1080	1152 × 864
	16 M colors (24-bit)	1280 × 1024	—
	16 M colors (32-bit)	1152 × 864	800 × 600

* Double-buffering, without Z-buffering.

Refresh rates

Display resolution*	Horizontal refresh rate (kHz)	Vertical refresh rate (Hz)
640 × 480	31–102	60–200
800 × 600	38–114	60–200
1024 × 768	48–113	60–140
1152 × 864	54–110	60–120
1280 × 1024	64–107	60–100
1600 × 1200	75–106	60–85
1920 × 1080	68–88	60–75
1920 × 1200	75–91	60–70
1800 × 1440	89–97	60–65

* Maximum refresh rates are attainable when using 8- or 16-bit color palettes.
Maximums may not be attainable at the highest display resolutions **with** a 24- or 32-bit color palette.

Supported VESA modes

In the table below, VESA modes supported by your Matrox graphics card are indicated by a VESA mode number. Many Super VGA DOS programs use VESA modes.

Display resolution	16 colors	256 colors	32 K colors	64 K colors	16 M colors
640 × 400	—	100	—	—	—
640 × 480	—	101	110	111	112
800 × 600	102	103	113	114	115
1024 × 768	—	105	116	117	118
1280 × 1024	—	107	119	11A	—
1600 × 1200	—	11C	11D	11E	—

To use higher refresh rates while in VESA display modes, see “DOS utilities” in the *readme* file in the root folder of the “Matrox Installation” CD-ROM.

Video (Matrox TV tuner required)

General display information

- “PAL” is the TV standard for the UK and other parts of Europe. PAL resolutions are the same as SECAM (standard for France).
- “NTSC” is the TV standard for North America.

Maximum video window resolutions for live video

There are maximum video window sizes (resolutions) for viewing live video (**TV** or **LINE** input). The following table lists the maximum sizes (measured in pixels) based on your graphics card, and the color palette and resolution settings of your display. (These resolutions are supported using a vertical refresh rate of 85 Hz or lower.)

b/p*	640 × 480	800 × 600	1024 × 768	1152 × 864	1280 × 1024
16	640 × 480	800 × 600	1024 × 768	1152 × 864	1280 × 1024

* With G100 graphics cards, the viewing of live video is supported only with a 16-bit color palette.

Hardware information

Features

	Productiva G100-Dual	Productiva G100-Dual with TV tuner	Productiva G100-Quad	Productiva G100-Quad with TV tuner
Graphics chips	2 × MGA-G100 (64-bit)	2 × MGA-G100 (64-bit)	4 × MGA-G100 (64-bit)	4 × MGA-G100 (64-bit)
RAMDAC	230 MHz (internal)	230 MHz (internal)	230 MHz (internal)	230 MHz (internal)
Memory	2 × 4 MB	2 × 4 MB	4 × 4 MB	4 × 4 MB
Memory type	SGRAM	SGRAM	SGRAM	SGRAM
TV tuner	—	✓	—	✓
Video input (Composite video; NTSC, PAL and SECAM)	—	✓	—	✓
Card type	PCI	PCI	PCI	PCI
Model #	G+/DUALP	G+/DUALP/N* G+/DUALP/1† G+/DUALP/UK‡	G+/QUADP	G+/QUADP/N* G+/QUADP/1† G+/QUADP/UK‡

* TV tuner for North America

† TV tuner for Western Europe

‡ TV tuner for the United Kingdom

Matrox add-ons (sold separately)

	Productiva G100-Dual	Productiva G100-Dual with TV tuner	Productiva G100-Quad	Productiva G100-Quad with TV tuner
Rainbow Runner G-Series (Video editing card)	✓	—	✓	—
DVD decoder	✓	✓	✓	✓

Matrox Productiva G100 Multi-Monitor Series

- Technical features –
 - Supports PCI bus version 2.1 at clock speeds up to 33 MHz
 - DEC 21152 PCI bridge controller
- Video specifications –
 - Separate sync monitors only
 - The video follows the PS/2 standard, with no sync on RGB, and no blanking pedestal. Black or blank – 0.0 V; White – 0.700 V.
 - There are five connections to a monitor that uses BNC (Bayonet Nut Connect) connectors – R, G, B, HSYNC (white or gray wire), and VSYNC (black wire).
- Environmental specifications –
 - Minimum/maximum ambient operating temperatures: 0 to 55° C
 - Minimum/maximum storage temperature: -40 to 75° C
 - Maximum altitude for operation: 3,000 meters
 - Maximum altitude for transport: 12,000 meters
 - Operating humidity: 20 to 80% relative humidity (non-condensing)
 - Storage humidity: 5 to 95% relative humidity (non-condensing)

Monitor connector pinouts

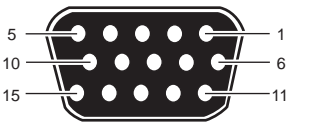
	<ul style="list-style-type: none"> 1 Analog red output 2 Analog green output 3 Analog blue output 4 Not connected 5-8 Ground 9 +5 V (DDC) 	<ul style="list-style-type: none"> 10 Ground 11 Not connected 12 SDA (DDC) 13 TTL horizontal sync 14 TTL vertical sync 15 SCL (DDC)
--	---	---

Customer support

Matrox Web and FTP sites

Matrox is on the Internet with a World Wide Web (WWW) and File Transfer Protocol (FTP) site. Our Web site has product literature, press releases, technical material, a sales office list, trade show information, and other relevant material. Our FTP site contains current drivers for Matrox products. You can download drivers using the Internet FTP site, in addition to our BBS. You can access our FTP server independently, or from the Matrox Web site.

Our address for Matrox Graphics Inc. is:

WWW; www.matrox.com/mga

FTP; [ftp.matrox.com/pub/mga/](ftp://ftp.matrox.com/pub/mga/)

Send questions or comments regarding the site to:

e-mail; webmaster@matrox.com

If you have a problem

If you have a problem, we recommend that you follow the procedure below for the quickest results.

- 1 Contact your dealer** – This is usually the quickest and most effective method of technical assistance. Your dealer is local and may be familiar with your complete system. In the case of hardware warranty assistance, the product must be returned to the dealer, who will return it to Matrox.
- 2 CompuServe** – If you have a modem and an account on CompuServe, you can get technical assistance and driver updates directly from Matrox by typing *GO MATROX* at the “!” prompt.
- 3 Matrox BBS** – You can download driver updates (which may eliminate a particular bug), utilities, and other information from our 24-hour Bulletin Board Service (BBS). The phone number is **514-685-6008**. The communication parameters are 8 data bits, 1 stop bit, and no parity. You’ll be prompted to enter your first and last name and a password. If you don’t have an account, it’s created when you enter your name for the first time. See also “Matrox Web and FTP sites”.
- 4 MATFAX instant fax** – Call our dial-up Matrox fax service at **514-685-0174**. Using a touch-tone phone, you can have faxes sent to you automatically 24 hours a day. Available documents include common installation problems, available drivers and updates, and product data sheets.

5 Direct Matrox Technical Assistance – If you still can't resolve a problem, you can get direct technical assistance four ways:

- Call Technical Support (Canada) at **514-685-0270**. For residents of Quebec only, call **514-822-6330**.
- Send a FAX to **514-822-6363**, Attention: Graphics Technical Assistance.
- Send e-mail to graphics.techsupport@matrox.com.
- Write a letter to Graphics Customer Support at our Corporate Headquarters. The address is: **Matrox Graphics Inc., 1055 St. Regis Blvd., Dorval, QC, Canada, H9P 2T4**.

Information we need

Please give a complete description of the problem, and include:



- Matrox card serial number, model number, revision number, BIOS number, driver type and version, and memory address at which the Matrox card is installed.
- Computer brand name, system BIOS manufacturer and version number or date, bus type, model, processor speed, and amount of memory.
- Monitor brand and model name.
- Operating system and version – if you're using a memory manager, its brand and version. Also, list any memory-resident programs in use.
- If you're using a network, its brand and version.
- Brand and model of any other cards and devices installed on your system.

Program specific problems

If a problem appears with a specific program, please give us the following information:

- Display settings (color palette, display resolution, and so on) applied when the problem occurs.
- Program name and version. Name any add-on packages you're using.
- If possible, take note of the file and segment address that caused the problem.
- Detailed steps known to cause the bug, so we can reproduce it.

Where to get information

- For display information:
 - **Windows NT 4.0** – click  → **Programs** → **Matrox PowerDesk NT** → **Matrox Display Properties** → **Information**.
- For system information:
 - **Windows 98** – click  → **Programs** → **Accessories** → **System Tools** → **System Information**.
 - **Windows NT 4.0** – click  → **Administrative Tools (Common)** → **Windows NT Diagnostics**.

Free CompuServe introductory membership offer

As a Matrox customer, you are entitled to a free Introductory Membership to CompuServe including:

- free access to CompuServe's Basic Services for one month
- \$15 introductory usage credit to explore the Matrox section on the Graphics B Vendor Forum and CompuServe's other Extended and Premium service offerings
- a personal User ID Number and Password
- a complimentary subscription to the monthly CompuServe magazine

To receive your free CompuServe introductory membership

- Call toll-free **1-800-524-3388** and ask for **Representative 229**.
 - In the United Kingdom, call **0800 289 378**.
 - In Germany, call **0130 37 32**.
 - In the rest of Europe, call **44 117 976 0681**.
 - Outside of the U.S., Canada, and Europe, call **614-529-1349**.

Contact Matrox on CompuServe to receive answers to questions you may have about our graphics accelerators and video products. You can receive:

- assistance on technical questions
- information on the latest products and upgrades
- tips on using Matrox products

Through CompuServe, you can directly contact Matrox technical representatives or other Matrox users. You can also take advantage of the many services CompuServe offers.

Warranty

A. Limited Warranty Statement

1. Matrox Graphics Inc. ("Matrox") warrants to the end-user customer, who provides adequate proof of purchase that Matrox hardware products purchased from Matrox authorized dealers will be free from defects in materials and workmanship for a period of three (3) years from the date of purchase. This warranty applies only to the original end-user purchaser and is non-transferable. Conditions and limitations of Matrox's warranty are stated below.
2. Matrox's limited warranty covers only those defects which arise as a result of normal use of the hardware and does not apply to any:
 - a. improper or inadequate maintenance;
 - b. incompatibilities due to the user's hardware or software applications with or in which the Matrox product interfaces;
 - c. product of a special or custom-made nature;
 - d. unauthorized modification or misuse;
 - e. improper installation, misapplication or negligence;
 - f. operation outside the product's environmental specifications;
 - g. improper site preparation or maintenance;
 - h. software;
 - i. other causes that do not relate to a product defect;
 - j. defects or damage suffered as a result of force majeure (including theft);
 - k. defects or damage suffered as a result of normal wear and tear; and/or
 - l. stolen goods.
3. If Matrox receives, during the applicable warranty period, notice of a defect in a warranted hardware product and the defective Matrox product in question, Matrox shall at its sole option, either repair or replace the product, and shall return the repaired product or a replacement product within a reasonable delay. The replacement product may not be new, provided that it has functionality at least equal to that of the product being replaced.
4. This warranty is valid in any country where Matrox hardware products are distributed by Matrox or its authorized dealers.
5. This Limited Warranty Statement gives the customer specific legal rights. The customer may also have other rights which vary from state to state in the United States, from province to province in Canada, and from country to country elsewhere in the world.

B. Limitations of Warranty

1. NEITHER MATROX NOR ANY OF ITS THIRD PARTY SUPPLIERS MAKES ANY OTHER WARRANTY OF ANY KIND, WHETHER EXPRESSED OR IMPLIED, WITH RESPECT TO MATROX PRODUCTS. MATROX SPECIFICALLY DISCLAIMS (and the customer, by accepting the Matrox product, specifically accepts such disclaimer and waives) ALL OTHER WARRANTIES, EITHER EXPRESSED OR IMPLIED, INCLUDING BUT NOT LIMITED TO THE IMPLIED WARRANTIES OF MERCHANTABILITY AND FITNESS FOR A PARTICULAR OR INTENDED PURPOSE OR USE AND THE WARRANTY AGAINST LATENT DEFECTS, WITH RESPECT TO THE HARDWARE AND/OR SOFTWARE.
2. To the extent that this Limited Warranty Statement is inconsistent with the law of the locality where the customer purchases the Matrox product, this Limited Warranty Statement shall be deemed modified to be consistent with such local law. Under such local law, certain limitations of this Limited Warranty Statement may not apply to the consumer.
3. To the extent allowed by local law, the remedies provided in this Limited Warranty Statement are the customer's sole and exclusive remedies.

C. Limitations of Liability

1. EXCEPT FOR THE OBLIGATIONS SPECIFICALLY SET FORTH IN THE LIMITED WARRANTY STATEMENT, IN NO EVENT SHALL MATROX BE LIABLE FOR:
 - a. any direct, indirect, special, incidental, consequential, foreseeable or unforeseeable, or punitive damages, whether based on contract, tort, delict or any other legal theory and whether advised of the possibility of such damages; and/or
 - b. damages arising from the loss of use, data, production revenue and/or profit of in connection with the Matrox product or any business interruption.
2. Without prejudice to the foregoing, any liability of Matrox for any breach of warranty shall be limited to the amount paid by the customer for the defective hardware in question.
3. To the extent allowed by local law, Matrox's entire liability and the customer's exclusive remedy shall be the repair or replacement of any defective product during the warranty period. Matrox does not offer any other warranty with respect to Matrox hardware or software or any other hardware or software.
4. Customer shall be responsible for all applicable taxes, duties and customs fees on any replacement unit, as well as all transport, insurance, storage and other charges incurred on all returned products.

D. Obtaining Service

1. Verify that your Matrox product was installed and configured according to the information in its accompanying documentation.
2. Read the "Troubleshooting" information included with the Matrox product to see if you can solve the problem yourself.
3. If you are still experiencing difficulties, please contact your dealer where you purchased your Matrox product.
4. If you must return a Matrox product, leave the configuration as it was when you were using it, and leave all identification stickers on the product. Pack the product in its original box and return to your Matrox dealer where the product was purchased, together with your proof of purchase. Your Matrox dealer will return the product for you. Alternatively, if this first option is unavailable to you, you may contact the Matrox Technical Support group who will issue an Return Merchandise Authorization (RMA) number, upon receipt of adequate proof of purchase, and inform you of shipping instructions. **DO NOT RETURN THE PRODUCT TO MATROX WITHOUT MATROX'S RMA NUMBER AND EXPRESS AUTHORIZATION.**

E. General

This limited warranty shall be governed by the laws of the Province of Quebec, Canada and the federal laws of Canada applicable therein and the courts of the Province of Quebec shall have exclusive jurisdiction to hear and decide any dispute instituted by the customer in connection with this limited warranty; the customer waives, by accepting the product, its rights to institute proceedings in connection with this warranty against Matrox in any jurisdiction other than Quebec.

Index

0-9

3D 5

A

acceleration, Matrox 5

address, Matrox 47

Adobe Acrobat 4

audio

adjusting 25

input 12

AVI 20, 24

B

BBS, Matrox 46

BIOS settings 33

BNC monitor connection 30

bus mastering 5

C

capture settings 22

CD-ROM, Matrox 4, 15, 36

Closed Captioning 24

color palette 27, 43

composite video

SCART 13

software setup 26

CompuServe 46, 48

copyright information 14

customer support 46–48, 49

D

DDC 16

disk

space 22

speed 37

display

drivers 17

information 42–43

document conventions 4

E

e-mail, Matrox 47

expansion slots 8, 28, 32

F

FAX, Matrox 46

frame capture 19, 24

FTP, Matrox 46

G

graphics

troubleshooting 28–35

H

hardware

acceleration 5, 34

information 44–45

installation 7–15

HD Benchmark 23, 38

I

input

audio 12

TV tuner 14

video camera 14

video player 11, 14

installation

Matrox card 7–15

software 15

IRQ settings 32, 33

M

monitor connector 29, 45

monitor settings 29, 31

Windows NT 4.0 16, 30

N

NTSC 22, 26, 43

O

online documentation 4

Matrox Video Tools 36

PC-VCR Remote 25

PowerDesk 16, 28

overlay mode 27

P

PAL 22, 26, 43

PCI 8, 32, 45

PC-VCR Remote 19–25

PDF 4

Plug-and-Play 16

preview mode 27

Q

quality

video 39

video files 22

R

RCA connectors 13

resolution

display 43

video window 43

RGB 27

S

SCART 12, 13

SECAM 22, 26, 43

software installation 15

software setup 31

sound

troubleshooting 40–41

T

- technical assistance 47
- Teletext 24
- troubleshooting 28–41
- TV tuner
 - connection setup 12
 - input 14
 - software setup 21, 25, 26
 - troubleshooting 36–40

V

- VESA 5
 - DDC monitor 16
 - modes (table) 43
- VGA 7, 43
- VidCap driver 26–27
- video camera 11, 14, 22
- video files
 - capturing 23
 - creating 22
 - file types 20
 - playback 20
 - quality 22
 - settings 22–23
- video input 11, 14, 22
 - troubleshooting 36–40
- video player 11, 14
- video snapshot 19, 24

W

- warning 7, 8, 16, 30
- warranty 49
- Web, Matrox 46
- Windows 98 15, 16, 33, 34, 35
- Windows NT 3.51 6
- Windows NT 4.0
 - display settings 17
 - Matrox software 17
 - monitor settings 16, 30

Software license agreement

Single User Products This Matrox software (the "Software") is copyrighted by Matrox Graphics Inc. All rights are reserved. The purchaser is granted a license to use the software only, subject to the following restrictions and limitations.

1. The license is for the original purchaser only, and is not transferable without written permission of Matrox.
2. The original purchaser may use the Software on a single computer owned or leased by the original purchaser. You may not use the Software on more than a single machine, even if you own or lease more than one machine, without written consent of Matrox.
3. The original purchaser may make back-up copies of the Software for his or her own use only, subject to the use limitations of this license.
4. The original purchaser may not engage in, nor permit third parties to engage in, any of the following:
 - Providing or disclosing the Software to third parties.
 - Providing use of the Software in a computer service business, network, time-sharing, multiple CPU or multi-user arrangement to users who are not individually licensed by Matrox.
 - Making alterations or copies of any kind in the Software (except as specifically permitted above).
 - Attempting to unassemble, de-compile or reverse engineer the Software in any way.
 - Granting sublicenses, leases, or other rights in the Software to others.
 - Making copies, or verbal or media translations, of the user's guide.
 - Making telecommunication data transmissions of the Software.

Matrox reserves the right to terminate this license if there is a violation of its term or default by the Original Purchaser. Upon termination, for any reason, all copies of the Software must be immediately returned to Matrox, and the Original Purchaser shall be liable to Matrox for any and all damages suffered as a result of the violation or default.

Limited warranty Matrox warrants to you, for a period of ninety (90) days normal use from your date of purchase, that:

1. The CD/disks on which the software is furnished and the documentation are not defective.
2. The Software is properly recorded upon the CD/disks included.
3. The documentation is substantially complete and contains all the information Matrox deems necessary to use the software.
4. The Software functions substantially as described in the documentation.

Matrox's entire liability and your exclusive remedy shall be the replacement of any CD/Disks or documentation not meeting these warranties, which is returned to Matrox or an authorized dealer, together with a copy of your paid receipt. The above is the only warranty of any kind, either express or implied, including, but not limited to the implied warranties of merchantability and fitness for a particular use that is made by Matrox on this Licensed Software. In no event shall Matrox be liable to you or to any third party for consequential, special, indirect or incidental damages which you may incur as a result of using the licensed software, including, but not limited to, loss of data, or information of any kind which you may experience.

Thank you for choosing Matrox

Please register online (www.matrox.com/register) to be eligible for customer support, new product announcements, and information on special offers and upcoming events.

matrox

Copyright © 1998 Matrox Graphics Inc. • (English) All rights reserved. • (Français) Tous droits réservés.
 • (Deutsch) Alle Rechte vorbehalten. • (Italiano) Tutti i diritti riservati. • (Español) Reservados todos los derechos.

**Trademarks • Marques déposées • Warenzeichen
 • Marchi registrati • Marcas registradas**

Matrox Electronic Systems Ltd.	Matrox [®] , Matrox Mystique [®]
Matrox Graphics Inc.	CenterWINDOW [™] , DeskNav [™] , Desktop Navigator [™] , DynaView [™] , Matrox m3D [™] , Matrox HD Benchmark [™] , Matrox Impression [™] , Matrox Marvel [™] , Matrox Media XL [™] , Matrox Millennium [™] , Matrox MMS [™] , Matrox Multi-Monitor Series [™] , Matrox PowerDesk [™] , Matrox Quick Connect [™] , MaxVIEW [™] , MGA [™] , MGA-G100 [™] , MGA-G200 [™] , Productiva [™] , QuickDesk [™] , Rainbow Runner [™] , MGA PowerDesk [™] , ModeSWITCH [™] , PanEND [™] , PanHOME [™] , PanLOCK [™] , PC-VCR Remote [™] , PixelTOUCH [™] , PowerDoc [™] , QCDP [™] , QuickAccess [™] , ResSwitch [™]
Adobe Systems Inc.	Acrobat [®] , Adobe [®]
Apple Computer, Inc.	Apple [®] , QuickTime [®]
Avid Technology, Inc.	Avid [®] , Avid Cinema [™] , Cecil B. DeMovie [™]
CompuServe Inc.	CompuServe [®]
Dolby Laboratories, Inc.	Dolby [®] , Dolby Digital [®]
Eastman Kodak Company	Kodak Precision [™]
Intel Corporation	Intel [®] , Indeo [®] , MMX [™] , Pentium [®]
International Business Machines Corporation	IBM [®] , OS/2 [®] , PowerPC [®] , VGA [®]
Microsoft Corporation	ActiveMovie [™] , ActiveX [™] , Direct3D [®] , DirectDraw [®] , DirectShow [™] , DirectVideo [™] , DirectX [™] , Microsoft [®] , MS-DOS [®] , Windows [®] , Windows 95 [™] , Windows 98 [™] , Windows for Workgroups [™] , Windows NT [™]
Radius Inc.	Cinepak [®]
Silicon Graphics, Inc.	OpenGL [®]
Ulead Systems, Inc.	Ulead [®] , MediaStudio [™] , Photo Express [™]
U.S. Environmental Protection Agency	Energy Star [™]
VDOnet Corporation Limited.....	VDOnet [®] , VDOPhone [™]
Zoran Corporation.....	Zoran [®] , SoftDVD [®]

• (English) All other nationally and internationally recognized trademarks and tradenames are hereby acknowledged. • (Français) Toutes les autres marques et tous les autres noms déposés reconnus nationalement ou internationalement sont également reconnus par les présentes. • (Deutsch) Alle sonstigen national und international bekannten Warenzeichen und Produktnamen werden hiermit anerkannt. • (Italiano) Eventuali altri nomi di prodotto menzionati in questo manuale sono dei proprietà di rispettivi produttori. • (Español) Por medio del presente se reconocen todas las demás marcas y nombres comerciales reconocidos a nivel nacional e internacional.

(English) Disclaimer

THE INFORMATION IN THIS GUIDE IS SUBJECT TO CHANGE AT ANY TIME AND WITHOUT NOTICE.

Matrox Graphics Inc. reserves the right to make changes in specifications at any time and without notice. The information provided by this document is believed to be accurate and reliable. However, no responsibility is assumed by Matrox Graphics Inc. for its use; nor for any infringements of patents or other rights of third parties resulting from its use. No license is granted under any patents or patent rights of Matrox Graphics Inc.

(Français) Responsabilité

LES INFORMATIONS CONTENUES DANS CE MANUEL PEUVENT ÊTRE MODIFIÉES À TOUT MOMENT SANS PRÉAVIS.

Matrox Graphics Inc. se réserve le droit de modifier les spécifications à tout moment sans préavis. Les informations contenues dans ce manuel sont reconnues comme étant précises et fiables. Cependant, Matrox Graphics Inc. n'assume aucune responsabilité concernant leur utilisation, ni leur contrefaçon ou les autres droits des tiers résultant de leur utilisation. Aucune licence n'est accordée sur aucun brevet ou droit d'exploiter un brevet de Matrox Graphics Inc.

(Deutsch) Haftungsablehnungserklärung

DIE IN DIESEM HANDBUCH ENTHALTENEN ANGABEN UND DATEN KÖNNEN OHNE VORHERIGE ANKÜNDIGUNG GEÄNDERT WERDEN.

Die Matrox Graphics Inc. behält sich das Recht vor, jederzeit und ohne Ankündigung technische Daten zu ändern. Es wird keine Garantie für die Richtigkeit des Inhalts dieses Handbuchs übernommen. Weiterhin übernimmt die Matrox Graphics Inc. keinerlei Verantwortung für die Benutzung dieses Handbuchs, weder für Verstöße gegen Patentrechte noch für andere Rechte Dritter, die aus seinem Gebrauch resultieren mögen. Es werden keinerlei Lizenzrechte gewährt für sämtliche Patente oder Patentrechte der Matrox Graphics Inc.

(Italiano) Discrezionalità

LE INFORMAZIONI CONTENUTE NEL PRESENTE DOCUMENTO SONO SOGGETTE A MODIFICHE SENZA PREAVVISO.

Matrox Graphics Inc. si riserva il diritto di apportare variazioni di qualunque tipo alle specifiche tecniche in qualunque momento e senza alcun preavviso. Le informazioni contenute in questa documentazione sono ritenute corrette e attendibili. In ogni caso, non è imputabile a Matrox Graphics Inc. nessuna responsabilità per il loro utilizzo, come nessuna violazione a brevetti o diritti di altri produttori derivante dal loro utilizzo.

(Español) Renuncia

LA INFORMACION QUE CONTIENE EL PRESENTE MANUAL ESTA SUJETA A CAMBIOS SIN PREVIO AVISO EN CUALQUIER MOMENTO.

Matrox Graphics Inc. se reserva el derecho de realizar modificaciones en cualquier momento y sin previo aviso. La información facilitada en este documento se considera que es exacta y fiable. Sin embargo, Matrox Graphics Inc. no asume ninguna responsabilidad por su uso; ni por cualquier infracción de patentes u otros derechos de terceras partes derivados de su uso. No se concede ninguna licencia bajo cualesquiera patentes o derechos de patentes de Matrox Graphics Inc.

Matrox Graphics Inc.

1055 St-Regis Blvd.
Dorval, Quebec
Canada H9P 2T4
Tel: (514) 822-6320
Fax: (514) 822-6363
Fax-back service: (514) 685-0174
BBS: (514) 685-6008
Technical support: (514) 685-0270
In Quebec, call: (514) 822-6330
E-mail: graphics.techsupport@matrox.com
Web site: www.matrox.com/mga

France

Matrox France SARL
2, rue de la Couture, Silic 225
94528 Rungis Cedex, France
Tél: 01 45.60.62.00
Fax: 01 45.60.62.05
Courrier élect.: tech_support_france@matrox.fr
Site Web: www.matrox.com/mga/francais

Italia

Agenzia Italiana di Matrox Graphics Inc.
3G electronics
via Boncompagni 3B
20139 Milano, Italia
Fax: 02-5253045
BBS: 02-5253044
Informazioni commerciali: 02-5253095
Posta elettronica: commerciale.3g@treg.it
Assistenza tecnica: 02-5253099
Posta elettronica: supporto.3g@treg.it
Sito Web: www.matrox.com/mga/italia

Deutschland

Matrox Electronic Systems GmbH
Inselkammerstraße 8
D-82008 Unterhaching bei
München, Deutschland
Tel: 089 614 474-0
Fax: 089 614 9743
BBS: 089 614 00 91
BBS (ISDN): 089 614 474-91
Vertriebs Infoline: 089 614 474-44
E-mail: 106335.760@compuserve.com
Technische Unterstützung: 089 614 474-33
E-mail: 106332.1007@compuserve.com
Web-Site: www.matrox.com/mga/deutsch

United Kingdom

Matrox (UK) Limited
Sefton Park
Stoke Poges
Buckinghamshire
England SL2 4JS
Tel: 01753 66 55 00
Fax: 01753 66 55 99
Sales: 01753 66 55 44
Technical support: 01753 66 55 22
E-mail: graphic.tech.uk@matrox.com

Hong Kong

Matrox Electronics Systems Ltd.
Rm. 1901, 19/F, Workington Tower
78 Bonham Strand E.
Sheung Wan, Hong Kong
Tel: 852-2877-5387
Fax: 852-2537-9530
E-mail: 100452.2432@compuserve.com

matrox