

Matrox® **Display Wall**

Mura™ IPX Series • D-Series™

System Builder's Guide

20315-101-0170
2024.02.12

video.matrox.com

matrox[®]
— video —

Contents

Product overview	5
Hardware summary – Mura IPX Series	5
MURAIPXI-E4SF/MURAIPXI-E4SHF	5
MURAIPXI-E2MF/MURAIPXI-E2MHF	6
MURAIPXI-D2MF/MURAIPXI-D2MHF	7
MURAIPXI-E4JF/MURAIPXI-E4JHF	8
MURAIPXI-D4JF/MURAIPXI-D4JHF	9
Hardware summary – Matrox D-Series	10
Matrox D1450.....	10
Matrox D1480.....	11
Why choose a validated platform?	12
Platforms validated by Matrox	12
Validated systems	12
Validated motherboards	13
Validated PCIe expansion solution	13
Validated chassis.....	14
D-Series system requirements	15
Validated systems.....	16
Before you begin.....	16
D-Series based video wall system	16
Third-party based video wall system.....	17
Currently supported systems.....	18
Boxx Technologies RAXX P4G_02	19
Boxx Technologies RAXX T3L_01	21
Dell Precision T7960	23
ECA EVS-290	25
ECA EVS-540-ASMB-815	27
ECA EVS-540-C621E	29
ECA EVS-540-X299	31
ECA EVS-840	33
ECA EVS-XL	36
GridVue GV-A427	39
GridVue GV-G714	41
GridVue GV-S427	44
HP ZCentral 4R Workstation	46
Lenovo Thinkstation P520	47
Lenovo Thinkstation P620	49
Portwell M8030	51
Portwell NURO-771R	53
Supermicro SYS-420GP-TNR	55
Supermicro SYS-5049A-TR	57
Supermicro SYS-540A-TR	59
Supermicro SYS-551A-T	61
Supermicro SYS-6049GP-TRT	63
EOL (End of Life) systems	65

Portwell M9030 (with ROBO-8113VG2AR SHB)	65
Validated motherboards	68
Currently supported motherboards	68
Advantech ASMB-815	70
Advantech PCE-5B12 with PCE-7131 / PCE-7129 SHB	73
Advantech PCE-5B19 with PCE-7131 / PCE-7129	76
Asrock C621A WS	79
Asrock Rack ROMED8-2T	81
ASUS Pro WS W790E-SAGE SE	83
ASUS Pro WS WRX80E-SAGE SE WIFI	85
ASUS Pro WS X299 SAGE II	87
ASUS WS C422 PRO/SE	89
ASUS WS C422 SAGE 10G	91
ASUS WS C621E SAGE	93
Gigabyte C246-WU4	95
Gigabyte MU72-SU0	97
Gigabyte WRX80-SU8-IPMI (rev 1.0)	99
MSI TRX40 PRO 10G	101
Supermicro C9Z390-PGW	103
Supermicro C9Z490-PG	105
Supermicro H11SSL-i	107
Supermicro X11SPA-TF/X11SPA-T	109
Supermicro X12SPA-TF	111
Supermicro X13SWA-TF	113
EOL (End of Life) motherboards	115
ASUS Pro WS C621 64L SAGE 10G	115
ASUS WS Z390 Pro	117
Portwell M9010A (with ROBO-8113VG2AR SHB)	119
Validated PCIe expansion boxes	121
Currently supported PCIe expansion box	121
OSS 4U Value 8-Slot Expansion System	121
Validated chassis	123
Currently supported chassis	123
Advantech ACP-4000	123
Advantech ACP-4010	124
Advantech IPC 623	124
Chenbro RM41300 FS81	125
PCICase IPC-C4FB-H chassis	125
Rackmaster 20 slot chassis	126
Rosewill RSV-L4000U	126
Sliger CX4170a	126
Supermicro CSE-747BTS-R2K20BP chassis	127
Supermicro SuperChassis 842XTQ-R606B	127
Supermicro SuperChassis 842XTQC-R804B	128
EOL (End of Life) chassis	129
Portwell 10 slot chassis	129

System ventilation.....	130
Power supply sizing for Matrox D-Series based and third-party based systems	131
Shipping an integrated system.....	131
PCI Express® bandwidth considerations in Matrox D-Series and Mura IPX Series based systems.....	132
Input source bandwidth requirements	132
PCI Express architecture overview	132
General bandwidth guidelines.....	134
A word about system architecture and performance	134
Contact us	136
Disclaimer.....	137

Product overview

Mura IPX Series products are PCIe ×8 Gen 2.0 cards that provide high-density capture, encode, and decode functionality to enhance video walls and operator workstations with advanced video processing and networking capabilities.

Hardware summary – Mura IPX Series

The Matrox Mura IPX Decode and IPX Encode/Decode Series of products include the following key features:

- Multi-channel 4K/HD/SD encode and decode over standard IP
- DisplayPort™, SDI, and HDMI® capture, IP encode, and IP decode support on a single card
- Flexible stream and record capabilities anywhere on the network
- Separate on-board network interface controller for zero impact on the system
- RGB 10:10:10 and 8:8:8 plus YUV 4:4:4, 4:2:2, and 4:2:0 color space support
- Ideal for control rooms, operation centers, board rooms and other mission critical environments as well as digital signage and presentation systems.

MURAIPXI-E4SF/MURAIPXI-E4SHF

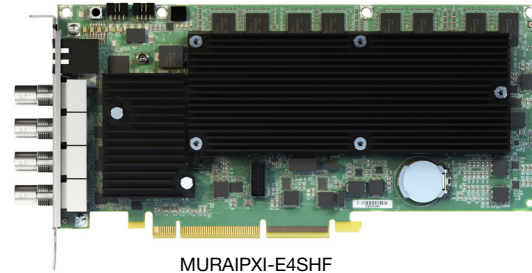
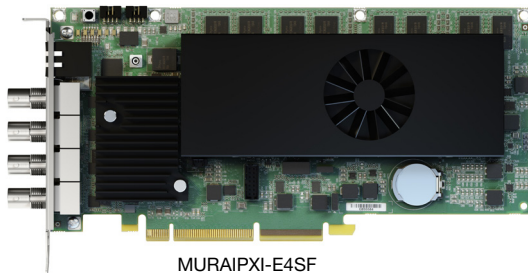

	MURAIPXI-E4SF	MURAIPXI-E4SHF
Part number	MURAIPXI-E4SF	MURAIPXI-E4SHF
Card type	PCIe ×16 2.0 (×16 mechanical, ×8 electrical)	PCIe ×16 2.0 (×16 mechanical, ×8 electrical)
Form factor	ATX	ATX
Connector	4× BNC 1x 100/1000 Base-T RJ45 Ethernet Port	4× BNC 1x 100/1000 Base-T RJ45 Ethernet Port
Memory	8 GB	8 GB
Output support	—	—
Input support	4× SDI + IP	4× SDI + IP
Decode support	Multi-channel 4K H.264	Multi-channel 4K H.264
Encode support	Multi-channel 4K H.264	Multi-channel 4K H.264
Power consumption	Typical: 27.12 W @ 12 V, 6.27 W @ 3.3 V, or 33.39 W Total	Typical: 27.12 W @ 12 V, 6.27 W @ 3.3 V, or 33.39 W Total
Weight	398 g	334 g
Dimensions	L: 9.02 in / W: 0.75 in / H: 4.38 in L: 22.91 cm / W: 1.91 cm / H: 11.13 cm	
Regulatory compliance	Class B: FCC, CE, RCM, VCCI, ICES-3, CSA, KC	

MURAI PXI-E2MF/MURAI PXI-E2MHF

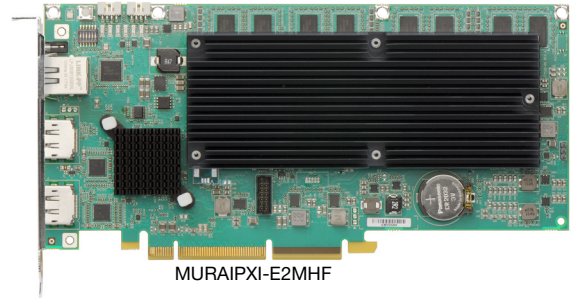
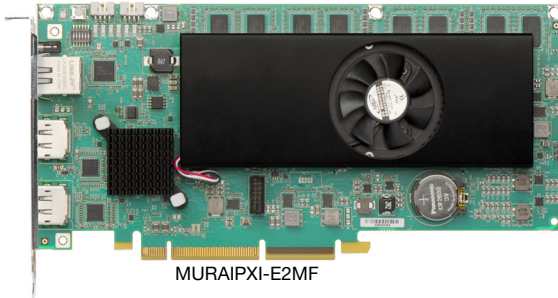

	MURAI PXI-E2MF	MURAI PXI-E2MHF
Part number	MURAI PXI-E2MF	MURAI PXI-E2MHF
Card type	PCIe x16 2.0 (x16 mechanical, x8 electrical)	PCIe x16 2.0 (x16 mechanical, x8 electrical)
Form factor	ATX	ATX
Connector	2x DisplayPort 1.2, 1x 100/1000 Base-T RJ45 Ethernet Port	2x DisplayPort 1.2, 1x 100/1000 Base-T RJ45 Ethernet Port
Memory	8 GB	8 GB
Output support	—	—
Input support	2x DisplayPort 1.2 + IP	2x DisplayPort 1.2 + IP
Decode support	Multi-channel 4K H.264	Multi-channel 4K H.264
Encode support	Multi-channel 4K H.264	Multi-channel 4K H.264
Power consumption	Typical: 24.6 W @ 12 V, 6.105 W @ 3.3 V, or 30.705 W Total	Typical: 24.6 W @ 12 V, 6.105 W @ 3.3 V, or 30.705 W Total
Weight	304 g	268 g
Dimensions	L: 9.02 in / W: 0.75 in / H: 4.38 in L: 22.91 cm / W: 1.91 cm / H: 11.13 cm	
Regulatory compliance	Class B: FCC, CE, RCM, VCCI, ICES-3, CSA, KC	

MURAI PXI-D2MF/MURAI PXI-D2MHF

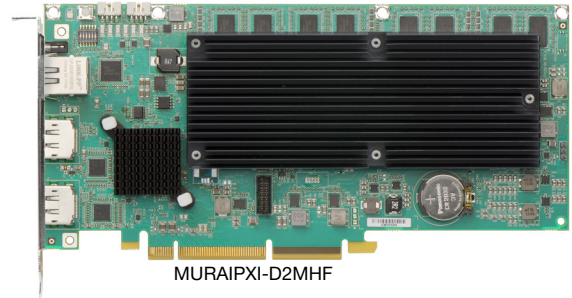
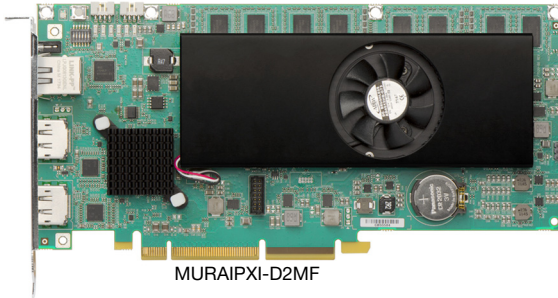

	MURAI PXI-D2MF	MURAI PXI-D2MHF
Part number	MURAI PXI-D2MF	MURAI PXI-D2MHF
Card type	PCIe x16 2.0 (x16 mechanical, x8 electrical)	PCIe x16 2.0 (x16 mechanical, x8 electrical)
Form factor	ATX	ATX
Connector	2x DisplayPort 1.2, 1x 100/1000 Base-T RJ45 Ethernet Port	2x DisplayPort 1.2, 1x 100/1000 Base-T RJ45 Ethernet Port
Memory	8 GB	8 GB
Output support	—	—
Input support	2x DisplayPort 1.2 + IP	2x DisplayPort 1.2 + IP
Decode support	Multi-channel 4K H.264	Multi-channel 4K H.264
Encode support	—	—
Power consumption	Typical: 24.6 W @ 12 V, 6.105 W @ 3.3 V, or 30.705 W Total	Typical: 24.6 W @ 12 V, 6.105 W @ 3.3 V, or 30.705 W Total
Weight	304 g	268 g
Dimensions	L: 9.02 in / W: 0.75 in / H: 4.38 in L: 22.91 cm / W: 1.91 cm / H: 11.13 cm	
Regulatory compliance	Class B: FCC, CE, RCM, VCCI, ICES-3, CSA, KC	

MURAIPIXI-E4JF/MURAIPIXI-E4JHF

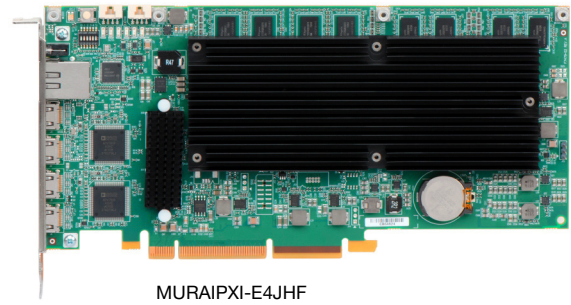
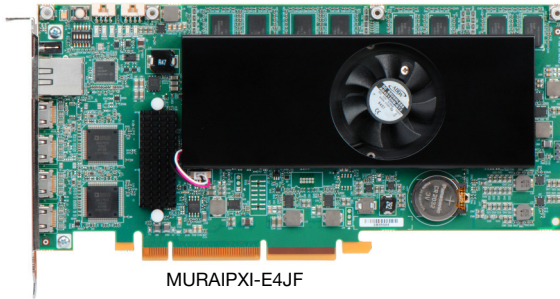

	MURAIPIXI-E4JF	MURAIPIXI-E4JHF
Part number	MURAIPIXI-E4JF	MURAIPIXI-E4JHF
Card type	PCIe x16 2.0 (x8 2.0 electrically)	PCIe x16 2.0 (x8 2.0 electrically)
Form factor	ATX	ATX
Connector	4x Mini HDMI (Type C), 1x 100/1000 Base-T RJ45 Ethernet Port	4x Mini HDMI (Type C), 1x 100/1000 Base-T RJ45 Ethernet Port
Memory	8 GB	8 GB
Output support	—	—
Input support	4x HDMI, IP	4x HDMI, IP
Decode support	Multi-channel 4K H.264	Multi-channel 4K H.264
Encode support	Multi-channel 4K H.264	Multi-channel 4K H.264
Power consumption	Typical: 24.6 W @ 12 V, 6.105 W @ 3.3 V, or 30.705 W Total	Typical: 24.6 W @ 12 V, 6.105 W @ 3.3 V, or 30.705 W Total
Weight	312 g	278 g
Dimensions	L: 9.02 in / W: 0.75 in / H: 4.38 in L: 22.91 cm / W: 1.91 cm / H: 11.13 cm	
Regulatory compliance	Class B: FCC, CE, RCM, VCCI, ICES-3, CSA, KC	

MURAIPIXI-D4JF/MURAIPIXI-D4JHF

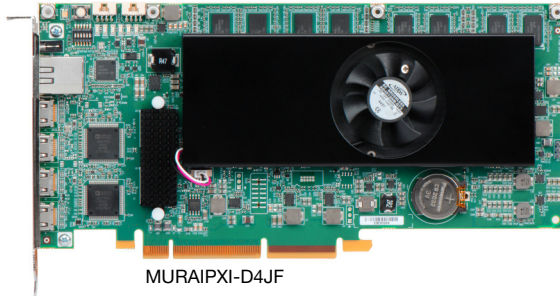

MURAIPIXI-D4JF

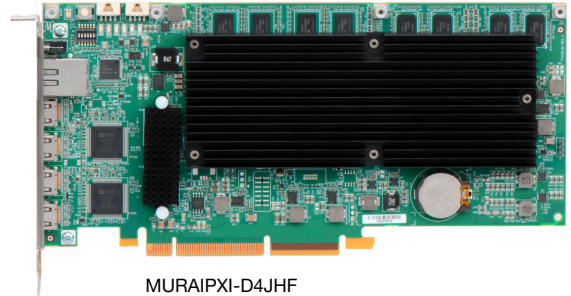

MURAIPIXI-D4JHF

	MURAIPIXI-D4JF	MURAIPIXI-D4JHF
Part number	MURAIPIXI-D4JF	MURAIPIXI-D4JHF
Card type	PCIe x16 2.0 (x8 2.0 electrically)	PCIe x16 2.0 (x8 2.0 electrically)
Form factor	ATX	ATX
Connector	4x Mini HDMI (Type C), 1x 100/1000 Base-T RJ45 Ethernet Port	4x Mini HDMI (Type C), 1x 100/1000 Base-T RJ45 Ethernet Port
Memory	8 GB	8 GB
Output support	—	—
Input support	4x HDMI, IP	4x HDMI, IP
Decode support	Multi-channel 4K H.264	Multi-channel 4K H.264
Encode support	—	—
Power consumption	Typical: 24.6 W @ 12 V, 6.105 W @ 3.3 V, or 30.705 W Total	Typical: 24.6 W @ 12 V, 6.105 W @ 3.3 V, or 30.705 W Total
Weight	304 g	268 g
Dimensions	L: 9.02 in / W: 0.75 in / H: 4.38 in L: 22.91 cm / W: 1.91 cm / H: 11.13 cm	
Regulatory compliance	Class B: FCC, CE, RCM, VCCI, ICES-3, CSA, KC	

Hardware summary – Matrox D-Series

The Matrox D-Series family of products includes the following key features:

- Pair up to four (4) D-Series cards for up to 16x synchronized 4096 x 2160 @ 60 Hz (HDMI) or 5120 x 3200 @ 60 Hz (DP1.4) outputs
- Support for an over-the-top ribbon synchronization cable (no need for additional synchronization card)
- PCIe x16 Gen3 bus interface for higher bandwidth capabilities
- HDCP compliant when used with Matrox Mura IPX HDMI Capture Series cards
- Matrox D1450 – Four HDMI outputs, each with a maximum resolution of 4096 x 2160 @ 60 Hz
- Matrox D1480 – Four DisplayPort 1.4 outputs, each with a maximum resolution of 5120 x 3200 @ 60 Hz
- Microsoft® DirectX 12.0 support enables latest professional applications
- Ideal for control rooms, operation centers, board rooms, and other critical environments as well as digital signage and presentation systems

Matrox D1450

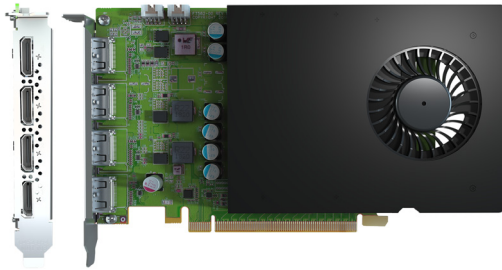

	Matrox D1450
Part number	D1450-E4GB
Card type	PCIe x16 3.0
Form factor	ATX
Connector	4x HDMI
Memory	4 GB GDDR5
Output support	4
Input support	—
Power consumption	50 W Total
Weight	256 g
Dimensions	L: 7.928 in / W: 0.737 in / H: 4.999 in L: 20.137 cm / W: 1.872 cm / H: 12.697 cm
Regulatory compliance	Class B: CE, FCC, ICES-3, KC, RCM

Matrox D1480

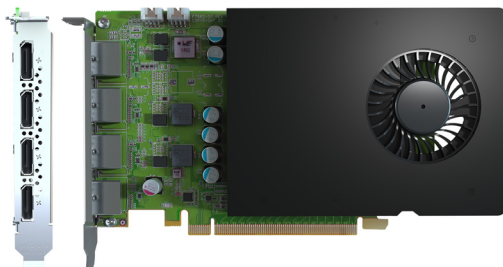

	Matrox D1480
Part number	D1480-E4GB
Card type	PCIe x16 3.0
Form factor	ATX
Connector	4x DisplayPort 1.4™
Memory	4 GB GDDR5
Output support	4
Input support	—
Power consumption	50 W Total
Weight	255 g
Dimensions	L: 7.928 in / W: 0.737 in / H: 4.999 in L: 20.137 cm / W: 1.872 cm / H: 12.697 cm
Regulatory compliance	Class B: CE, FCC, ICES-3, KC, RCM

Why choose a validated platform?

Matrox display wall products are designed for control rooms, operation centers, and other critical environments that require stable, reliable, and durable solutions. Matrox display wall products work in numerous non-validated, commercial-off-the-shelf (COTS) motherboards and systems, but only a select few of these off-the-shelf solutions can be thoroughly tested, verified, and validated by Matrox. Choosing a validated platform guarantees a high-quality solution to drive your display wall system.

Some of the key benefits of using a Matrox-validated platform include:

- **Optimized performance** – Carefully selected by Matrox to ensure better performance, a validated platform guarantees that your display wall product will work at or close to optimum performance.
- **Extensive validation process** – Systems are put to the test by Matrox Engineering, QA, Sales, and Marketing departments. From development and testing to sales and product demos, our employees use these systems in various practices to monitor performance. Using a validated platform guarantees the same level of performance experienced by Matrox staff.
- **Easier deployment** – Using an already validated system takes the guesswork out of building a display wall system. Integrators can use a validated platform to quickly and easily deploy solutions across a wide range of project sizes.
- **Faster customer support** – Customer support is faster, easier, and more precise because our technical support team is already familiar with the validated system you’re using.
- **Uncompromised compatibility** – Using a validated platform ensures that your display wall product has been thoroughly tested and verified for uncompromised compatibility.
- **Improved reliability** – Systems validated by Matrox have guaranteed thermal and ventilation characteristics, resulting in better product longevity.

Platforms validated by Matrox

Matrox is constantly reviewing new systems and looking to validate new platforms across multiple price points. Any system suggestions are welcome. The following tables are summaries of the active list.

Validated systems

Validated System	Maximum number of boards supported per system
Boxx Technologies RAXX P4G_02	10
Boxx Technologies RAXX T3L_01	7
Dell Precision T7960	8
ECA EVS-290	2
ECA EVS-540-ASMB-815	5
ECA EVS-540-C621E	7
ECA EVS-540-X299	7
ECA EVS-840	10
ECA EVS-XL	14
GridVue GV-A427	7
GridVue GV-G714	14
GridVue GV-S427	7
HP ZCentral 4R Workstation	3
Lenovo Thinkstation P520	4
Lenovo Thinkstation P620	6
Portwell M8030	8

Validated System	Maximum number of boards supported per system
Portwell NURO-771R	7
Supermicro SYS-420GP-TNR	12
Supermicro SYS-5049A-TR	7
Supermicro SYS-540A-TR	7
Supermicro SYS-551A-T	6
Supermicro SYS-6049GP-TRT	20

Validated motherboards

Validated motherboard	Maximum number of boards supported per system
Advantech ASMB-815	5
Advantech PCE-5B12 with PCE-7131 / PCE-7129 SHB	10
Advantech PCE-5B19 with PCE-7131 / PCE-7129	15
Asrock C621A WS	7
Asrock Rack ROMED8-2T	7
ASUS Pro WS W790E-SAGE SE	7
ASUS Pro WS WRX80E-SAGE SE WIFI	7
ASUS Pro WS X299 SAGE II	7
ASUS WS C422 PRO/SE	4
ASUS WS C422 SAGE 10G	7
ASUS WS C621E SAGE	7
Gigabyte C246-WU4	4
Gigabyte MU72-SU0	7
Gigabyte WRX80-SU8-IPMI (rev 1.0)	7
MSI TRX40 PRO 10G	4
Portwell M9010A (with ROBO-8113VG2AR SHB)	10
Supermicro C9Z390-PGW	4
Supermicro C9Z490-PG	4
Supermicro H11SSL-i	4
Supermicro X11SPA-TF/X11SPA-T	7
Supermicro X12SPA-TF	7
Supermicro X13SWA-TF	6

Validated PCIe expansion solution

Validated expansion solution	Maximum number of boards supported per system
OSS 4U Value 8-Slot Expansion System	8

Validated chassis

Validated chassis	Currently supported motherboards
Advantech ACP-4000 Advantech ACP-4010	<ul style="list-style-type: none"> ▪ Advantech ASMB-815 ▪ Advantech ASMB-815 ▪ ASUS PRO WS X299 SAGE II ▪ ASUS WS C621E SAGE
Advantech IPC 623	<ul style="list-style-type: none"> ▪ Advantech PCE-5B12 (BP)/PCE-7129 (SHB) ▪ Advantech PCE-5B12 (BP)/PCE-7131 (SHB) ▪ Advantech PCE-5B19 (BP)/PCE-7129 (SHB) ▪ Advantech PCE-5B19 (BP)/PCE-7131 (SHB)
Chenbro RM41300 FS81	<ul style="list-style-type: none"> ▪ Asrock C621A WS ▪ Asrock Rack ROMED8-2T ▪ ASUS Pro WS C621-64L SAGE/10G ▪ ASUS Pro WS W790E-SAGE SE ▪ ASUS Pro WS X299 SAGE II ▪ ASUS WS C422 PRO/SE ▪ ASUS WS C422 SAGE/10G ▪ ASUS WS C621E SAGE ▪ Gigabyte C246-WU4 ▪ Gigabyte MU72-SU0 ▪ Gigabyte WRX80-SU8-IPMI (rev 1.0) ▪ MSI TRX40 PRO 10G
PCICase IPC-C4FB-H chassis	<ul style="list-style-type: none"> ▪ ASUS Pro WS C621-64L SAGE/10G ▪ ASUS Pro WS X299 SAGE II ▪ ASUS WS C422 PRO/SE ▪ ASUS WS C422 SAGE/10G ▪ Gigabyte C246-WU4 ▪ Gigabyte MU72-SU0 ▪ MSI TRX40 PRO 10G ▪ Supermicro C9Z390-PGW ▪ Supermicro C9Z490-PG ▪ Supermicro H11SSL-i
Rackmaster 20 slot chassis	<ul style="list-style-type: none"> ▪ Advantech PCE-5B12 (BP)/PCE-7129 (SHB) ▪ Advantech PCE-5B12 (BP)/PCE-7131(SHB) ▪ Advantech PCE-5B19 (BP)/PCE-7129 (SHB) ▪ Advantech PCE-5B19 (BP)/PCE-7131 (SHB)
Rosewill RSV-L4000U	<ul style="list-style-type: none"> ▪ Asrock C621A WS ▪ Asrock Rack ROMED8-2T ▪ ASUS Pro WS W790E-SAGE SE ▪ ASUS Pro WS X299 SAGE II ▪ ASUS WS C422 PRO/SE ▪ ASUS WS C422 SAGE/10G ▪ ASUS WS C621E SAGE ▪ Gigabyte C246-WU4 ▪ Gigabyte MU72-SU0 ▪ Gigabyte WRX80-SU8-IPMI (rev. 1.0) ▪ MSI TRX40 PRO 10G
Sliger CX4170a	<ul style="list-style-type: none"> ▪ ASUS Pro WRX80E-SAGE SE WIFI

Validated chassis	Currently supported motherboards
Supermicro CSE-747BTS-R2K20BP chassis	<ul style="list-style-type: none"> ▪ Supermicro X11SPA-TF/X11SPA-T ▪ Supermicro X12SPA-TF ▪ Supermicro X13SWA-TF
Supermicro SuperChassis 842XTQ-R606B	<ul style="list-style-type: none"> ▪ Supermicro C9Z390-PGW ▪ Supermicro C9Z490-PG ▪ Supermicro H11SSL-i
Supermicro SuperChassis 842XTQC-R804B	<ul style="list-style-type: none"> ▪ Asrock C621A WS ▪ ASUS Pro WS C621-64L SAGE/10G ▪ ASUS Pro WS W790E-SAGE SE ▪ ASUS Pro WS X299 SAGE II ▪ ASUS WS C422 PRO/SE ▪ ASUS WS C422 SAGE/10G ▪ Gigabyte C246-WU4 ▪ Gigabyte MU72-SU0 ▪ MSI TRX40 PRO 10G ▪ Supermicro C9Z390-PGW ▪ Supermicro C9Z490-PG ▪ Supermicro H11SSL-i ▪ Supermicro X11SPA-TF/X11SPA-T

D-Series system requirements

For D-Series based display walls (with or without Mura IPX Series cards), the demands and requirements of a system are more generic. To use as a D-Series based display wall, a system *must* meet the following requirements:

- The system *must* be properly ventilated and the Mura IPX Series and D-Series cards must not exceed the maximum allowed temperature. For more information, see “System ventilation”, page 130.
- Mura IPX Series cards used in a non-validated system *must* have a fansink.
- The system *must* be populated with at least 32 GB of system memory. In addition, ensure to have all the memory channels populated. For example, if your system or motherboard has four memory channels, make sure to populate all the channels to add up to 32 GB (8 GB per channel totaling to 32 GB).



Note: If there are two DIMM slots per memory channel, you must populate at least one DIMM slot for each channel for optimal memory bandwidth. Follow the system manufacturer’s guideline for memory population sequence.



Note: We recommend choosing memory from the system or motherboard manufacturer’s supported list. The actual memory frequency may differ depending on the CPU types and the memory module used.

Validated systems

The following systems have been validated by Matrox to work with the Matrox Mura IPX Series and the Matrox D-Series (D1450 and D1480) products.



Note: Ensure that you have the following default settings to launch the Windows 10 operating system:

- In the system BIOS main page, go to **Boot Tab** → **Boot Mode Select** and select **UEFI**.
- In the system BIOS main page, go to **Boot Tab** → **CSM** → **Launch CSM** and select **Disabled**.

Before you begin

To ensure optimal performance, read the following guidelines before installing your Matrox graphics hardware.

D-Series based video wall system



Note: Always insert your *D-Series* in the *PCIe® 2.0 / 3.0 / 4.0 / 5.0 ×16* slots and your *Mura IPX Series* cards in the *PCIe® 2.0 / 3.0 / 4.0 / 5.0 ×16 or ×8* slots (×16 or ×8 electrical).



Note: To avoid possible problems, we recommend you use only Matrox PowerDesk software to change your display settings. Third-party console displays can only be used in independent mode.

- **D-Series and Mura IPX Series** – Insert these cards in the PCIe ×16 slots that are ×16 /×8 electrical.
- **Console display** – To add a console display to your D-Series based system, you can use the following graphics cards in a PCIe ×4 slot:
 - Matrox M9148 LP PCIe x16
 - Matrox M9140 LP PCIe x16
 - Matrox M9138 LP PCIe x16
 - Matrox M9128 LP PCIe ×16
 - Matrox M9120 Plus LP PCIe ×16
 - Matrox M9120 Plus LP PCIe x1
 - Matrox M9120 PCIe x16
 - AMD Radeon Vega 8 (onboard)
 - AMD Radeon WX2100
 - ASPEED AST2500 (onboard)
 - Intel® HD Graphics 530 (onboard)
 - Intel® HD Graphics 630 (onboard)
 - Intel® UHD Graphics 630 (onboard)
 - NVIDIA® GeForce GT710
 - NVIDIA® Quadro K620
 - NVIDIA® Quadro P400
 - NVIDIA® Quadro P600

- NVIDIA® Quadro P620



Note: Console is supported with 3.05 driver onwards.

Supported configurations

- Up to 4 x D1450
- Up to 4 x D1450 and multiple Mura IPX Capture Series cards
- Up to 4 x D1480
- Up to 4 x D1480 and multiple Mura IPX Capture Series cards

Third-party based video wall system



Note: Always insert your *third-party graphics hardware* in the *PCIe® 2.0 / 3.0 / 4.0 / 5.0 ×16* slots and your *Mura IPX Series* cards in the *PCIe® 2.0 / 3.0 / 4.0 / 5.0 ×16 or ×8* slots (×16 or ×8 electrical).

Supported configurations

- Intel® HD Graphics 530 graphics hardware + multiple Mura IPX Series 4K capture cards
- Intel® HD Graphics 630 graphics hardware + multiple Mura IPX Series 4K capture cards
- Intel® UHD Graphics 630 graphics hardware + multiple Mura IPX Series 4K capture cards
- NVIDIA® P4000 + multiple Mura IPX series 4K capture cards
- NVIDIA® P5000 + multiple Mura IPX Series 4K capture cards
- NVIDIA® P6000 + multiple Mura IPX Series 4K capture cards
- NVIDIA® RTX 2060 + multiple Mura IPX Series 4K capture cards
- NVIDIA® RTX 5000 + multiple Mura IPX Series 4K capture cards
- AMD Vega 64 + multiple Mura IPX Series 4K capture cards
- AMD W5700 + multiple Mura IPX Series 4K capture cards
- AMD WX7100 + multiple Mura IPX Series 4K capture cards
- AMD WX9100 + multiple Mura IPX Series capture cards

For the latest list of supported third-party graphics hardware, see the release notes for your Mura display wall driver.



Note: Optional power supply may be required for maximum support of third-party graphics hardware.



Note: If your power supply has an insufficient number of 6-pin connectors to support the maximum number of third-party graphics hardware, you can order optional power cables. For more information on power requirements, see the documentation for your third-party graphics hardware.



Note: Mura IPX Series cards leverage DirectX under Windows and OpenGL under Linux. Therefore, Matrox doesn't foresee any compatibility issues with other third-party graphics brands and models or other configurations not mentioned above. Although Matrox strives to test a wide variety of setups and configurations of the most common use-cases, it's impossible to test all possible setups and configurations. If you're having any issues with the setup of your third-party graphics + Mura IPX Series configuration, we recommend first removing all Mura IPX Series cards to verify the stability of the isolated third-party graphics configuration. If you have any questions or a request for a specific brand and model to be tested, contact us at DWCSupport@matrox.com.

Currently supported systems

The following systems have been validated by Matrox to work with Matrox Mura IPX Series and Matrox D-Series products.

Validated system	Maximum number of boards supported per system
Boxx Technologies RAXX P4G_02	10
Boxx Technologies RAXX T3L_01	7
Dell Precision T7960	8
ECA EVS-290	2
ECA EVS-540-ASMB-815	5
ECA EVS-540-C621E	7
ECA EVS-540-X299	7
ECA EVS-840	10
ECA EVS-XL	14
GridVue GV-A427	7
GridVue GV-G714	14
GridVue GV-S427	7
HP ZCentral 4R Workstation	3
Lenovo Thinkstation P520	4
Lenovo Thinkstation P620	6
Portwell M8030	8
Portwell NURO-771R	7
Supermicro SYS-420GP-TNR	12
Supermicro SYS-5049A-TR	7
Supermicro SYS-540A-TR	7
Supermicro SYS-551A-T	6
Supermicro SYS-6049GP-TRT	20



Note: For improved performance, we recommend you avoid using PCIe® x4 slots or lower.

Boxx Technologies RAXX P4G_02

	D-Series based controllers	Third-party based controllers
Validated	Yes	No foreseeable compatibility issues

Maximum number of cards supported	10
Maximum supported Mura IPX Series	9
Maximum supported D-Series	4
Motherboard	Gigabyte MZ32-AR0-00 base board 2 x NextGen3 OCuLink x16 expander boards
Chipset	SoC
Processor	AMD EPYC 7402P CPU @ 2.8 GHz
Heatsink (for CPU)	SP3
System BIOS version	Gigabyte R23, 3/30/2021
System memory	128 GB DDR4 ECC RDIMM
Chassis	4U
Power supply	4x 1620 W redundant power supply
PCIe expansion slots	<ul style="list-style-type: none"> 10 PCIe x16 3.0 slots (x16 mechanical and electrical)
Notes	<ul style="list-style-type: none"> On-board console support with D-Series controller. Requires 3.05 or later drivers. The two expander boards are plugged into slots 3 and 4 of the Gigabyte baseboard via PCIe Redriver link cards. There are eight memory channels. Ensure to have at least one DIMM populated per memory channel for optimized performance.

Configurations

PCIe Expansion Board Slot	D-Series based controller		Third-party based controller	
	Main	Option	Main	Option
CON1(Expansion A)	D1480	B	Third-party graphics hardware	-
CON2(Expansion A)	MURAI PXI-E4JHF	A	MURAI PXI-E4JHF	A
CON3(Expansion A)	MURAI PXI-E4JHF	A	MURAI PXI-E4JHF	A
CON4(Expansion A)	MURAI PXI-E4JHF	A	MURAI PXI-E4JHF	A
CON5(Expansion A)	D1480	A, B	Third-party graphics hardware	A
CON1(Expansion B)	D1480	A, B	Third-party graphics hardware	A
CON2(Expansion B)	MURAI PXI-E4JHF	A	MURAI PXI-E4JHF	A
CON3(Expansion B)	MURAI PXI-E4JHF	A	MURAI PXI-E4JHF	A
CON4(Expansion B)	MURAI PXI-E4JHF	A	MURAI PXI-E4JHF	A
CON5(Expansion B)	D1480	A, B	Third-party graphics hardware	A

Performance considerations with D-Series controller

PCIe Expansion Board Slot	Connectivity	Configuration 1	Configuration 2	Configuration 3	Configuration 4
CON1(Expansion A)	x16	B	B	B	B
CON2(Expansion A)	x16	A	A	A	A
CON3(Expansion A)	x16	A	A	A	A
CON4(Expansion A)	x16	A	A	A	A
CON5(Expansion A)	x16	A	A	B	B
CON1(Expansion B)	x16	A	B	B	B
CON2(Expansion B)	x16	A	A	A	A
CON3(Expansion B)	x16	A	A	A	A
CON4(Expansion B)	x16	A	A	A	A
CON5(Expansion B)	x16	A	A	A	B

Option	Product
A	MURAI PXI-E4SF, MURAI PXI-E4SHF, MURAI PXI-D2MF, MURAI PXI-D2MHF, MURAI PXI-E2MF, MURAI PXI-E2MHF, MURAI PXI-D4JF, MURAI PXI-D4JHF, MURAI PXI-E4JF, or MURAI PXI-E4JHF
B	D1450 or D1480

Boxx Technologies RAXX T3L_01

	D-Series based controllers	Third-party based controllers
Validated	Yes	No foreseeable compatibility issues

Maximum number of cards supported	7
Maximum supported Mura IPX Series	6
Maximum supported D-Series	4
Motherboard	Gigabyte GA-WRX80-SU8-IPMI
Chipset	AMD WRX80
Processor	AMD Ryzen Threadripper Pro 3955WX 3.9 GHz CPU
Heatsink (for CPU)	sWRX8 4094
System BIOS version	WRX80SU8-F4.08, 2021-10-27
System memory	64 GB DDR4 ECC RDIMM
Chassis	3U
Power supply	2 x 2000 W Redundant power supply
PCIe expansion slots	<ul style="list-style-type: none"> ▪ 6 PCIe x16 4.0 slots (x16 mechanical and electrical) ▪ 1 PCIe x16 4.0 slot (x16 mechanical and x8 electrical)
Notes	<ul style="list-style-type: none"> ▪ The system fan speed must be set at full speed for proper thermal ventilation. Connect to BMC web UI to access the fan control. BMC firmware F1.1.1 or later is required to access fan control. Refer to system/Motherboard manufacturer's user manual to log in to BMI web interface and access fan control. ▪ The ambient temperature must not exceed 35 degrees centigrade. ▪ Ensure to have the following VGA settings in the system BIOS: Go to Advanced → Legacy Video Select → On Board/External VGA → and select Onboard. ▪ On-board console support with D-Series controller. Requires 3.05 or later drivers. ▪ Ensure to have the following settings for Above 4G Decoding in the system BIOS: Go to Advanced → PCI Subsystem Settings → Above 4G Decoding → and select Enabled. ▪ There are eight memory channels. Ensure to have at least one DIMM populated per memory channel for optimized performance. ▪ Make sure the coolant pipes are tucked and routed well under the PSU cage. This is to avoid any conflict with the add-in cards on Slot7.

Configurations

Slot	D-Series based controller		Third-party based controller	
	Main	Option	Main	Option
Slot1	MURAIPIXI-E4JHF	A	MURAIPIXI-E4JHF	A
Slot2	MURAIPIXI-E4JHF	A	MURAIPIXI-E4JHF	A
Slot3	D1480	B	Third-party graphics hardware	-
Slot4	D1480	A, B	Third-party graphics hardware	A
Slot5	MURAIPIXI-E4JHF	A	MURAIPIXI-E4JHF	A
Slot6	D1480	A, B	Third-party graphics hardware	A
Slot7	D1480	A, B	Third-party graphics hardware	A

Performance considerations with D-Series controller

Slot	Connectivity	Configuration 1	Configuration 2	Configuration 3	Configuration 4
Slot1	x16	A	A	A	A
Slot2	x8	A	A	A	A
Slot3	x16	B	B	B	B
Slot4	x16	A	A	B	B
Slot5	x16	A	B	A	A
Slot6	x16	A	A	A	B
Slot7	x16	A	A	B	B

Option	Product
A	MURAI PXI-E4SF, MURAI PXI-E4SHF, MURAI PXI-D2MF, MURAI PXI-D2MHF, MURAI PXI-E2MF, MURAI PXI-E2MHF, MURAI PXI-D4JF, MURAI PXI-D4JHF, MURAI PXI-E4JF, or MURAI PXI-E4JHF
B	D1450 or D1480

Dell Precision T7960

	D-Series based controllers	Third-party based controllers
Validated	Yes	No foreseeable compatibility issues
Maximum number of cards supported	8	
Maximum supported Mura IPX Series	7	
Maximum supported D-Series	4	
Validated OS	Windows 10 Enterprise LTSC; Version 10.0.19045 Build 19045	
Chipset	Intel® W790	
Processor	Intel® Xeon® W5-3435 CPU @ 3.10 GHz	
Heatsink (for CPU)	LGA 4677	
System BIOS version	1.0.3, 3/27/2023	
System memory	64 GB (4x 16 GB 4800 MHz ECC DDR5 RDIMM)	
Chassis	Dell Precision T7960	
Power supply	2200 W	
PCIe expansion slots	<ul style="list-style-type: none"> ▪ 2 full-height Gen5 PCIe x16 slots ▪ 2 full-height Gen4 PCIe x16 slots ▪ 2 full-height Gen4 PCIe x8 slots ▪ 2 full-height, half length Gen4 PCIe x8 slots (x4 electrical) 	
Notes	<ul style="list-style-type: none"> ▪ The system fans speed must be set to full speed. In the system BIOS go to Advanced → Power → Thermal Management → select Ultra Performance for all. ▪ In the system BIOS go to Advanced → Performance → PCIe Resizable Address Register (BAR) → select Enabled. ▪ In the system BIOS go to Advanced → Integrated Devices → select Limit system memory to less than 1TB. 	

Configurations

Slot	D-Series based controller		Third-party based controller	
	Main	Option	Main	Option
SLOT1 PCIe5x16	D1480	B	Third-party graphics hardware	-
SLOT2 PCIe4x8(4)	MURAI PXI-E4JHF	A, C	MURAI PXI-E4JHF	A
SLOT3 PCIe4x8(4)	MURAI PXI-E4JHF	A	MURAI PXI-E4JHF	A
SLOT4 PCIe4x16	D1480	A, B	Third-party graphics hardware	A
SLOT5 PCIe5x16	D1480	A, B	Third-party graphics hardware	A
SLOT6 PCIe4x8	MURAI PXI-E4JHF	A	MURAI PXI-E4JHF	A
SLOT7 PCIe4x8	MURAI PXI-E4JHF	A	MURAI PXI-E4JHF	A
SLOT8 PCIe4 x16	D1480	A, B	Third-party graphics hardware	A

Performance considerations with D-Series controller

Slot	Connectivity	Configuration 1	Configuration 2	Configuration 3	Configuration 4
SLOT1PCIe5x16	x16	B	B	B	B
SLOT2PCIe4x8(4)*	x4	A	A	A	A
SLOT3PCIe4x8(4)*	x4	A	A	A	A
SLOT4PCIe4x16	x16	A	A	B	B
SLOT5PCIe5x16	x16	A	B	B	B
SLOT6PCIe4x8	x8	A	A	A	A
SLOT7 PCIe4x8	x8	A	A	A	A
SLOT8 PCIe4 x16	x16	A	A	A	B

Note: * Mura IPX performance in the x4 slot is reduced by half.

Option	Product
A	MURAI PXI-E4SF, MURAI PXI-E4SHF, MURAI PXI-D2MF, MURAI PXI-D2MHF, MURAI PXI-E2MF, MURAI PXI-E2MHF, MURAI PXI-D4JF, MURAI PXI-D4JHF, MURAI PXI-E4JF, or MURAI PXI-E4JHF
B	D1450 or D1480
C	Matrox M9148 LP PCIe x16, Matrox M9140 LP PCIe x16, Matrox M9138 LP PCIe x16, Matrox M9128 LP PCIe x16, Matrox M9120 Plus LP PCIe x16, Matrox M9120 Plus LP PCIe x1, Matrox M9120 PCIe x16, NVIDIA Quadro P600, NVIDIA Quadro K620, NVIDIA GeForce GT710, AMD Radeon WX2100, or AMD Radeon Vega 8 (add-in card console options)

ECA EVS-290

	D-Series based controllers	Third-party based controllers
Validated	Yes	No foreseeable compatibility issues
Maximum number of cards supported	2	
Maximum supported Mura IPX Series	1	
Maximum supported D-Series	2	
Motherboard	Advantech ASMB-786MB	
Chipset	Intel C246	
Processor	Intel® Xeon® E-2278GE CPU@ 3.30 GHz, or Intel® Core™ i7-9700E CPU @ 2.60 GHz	
Heatsink (for CPU)	LGA 1151	
System BIOS version	5.13, 2019-08-30	
System memory	32 GB DDR4 ECC Memory (Intel Xeon E-2278GE) 32 GB DDR4 non-ECC memory (Intel i7-9700E)	
Chassis	Advantech IPC-7130	
Power supply	500 W power supply	
PCIe expansion slots	<ul style="list-style-type: none"> ▪ 1 Gen 3.0 PCIe x16 link (or two PCIe x16 slots with x8 link) ▪ 2 PCIe x4 slots 	
Notes	<ul style="list-style-type: none"> ▪ Go to the system BIOS main page → H/W Monitor Tab → Smart Fan Function → and set to Normal mode. ▪ Ensure to have the following default settings for GPU. Go to the system BIOS main page → Chipset → System Agent (SA) Configuration → Graphics Configuration → and select: <ul style="list-style-type: none"> ▪ Primary Display → AUTO ▪ Internal Graphics → Enabled ▪ In the system BIOS main page, go to Chipset → System Agent(SA) Configuration → Above 4GB MMIO BIOS Assignment → and select Enabled. ▪ On-board console support with D-Series controller. Requires 3.05 or later drivers. 	

Configurations

Slot	D-Series based controller		Third-party based controller	
	Main	Option	Main	Option
PCIEX1_SLOT1	N/A		N/A	
PCIEX4_SLOT2	N/A		N/A	
PCIEX1_SLOT3	N/A		N/A	
PCIEX16_SLOT4	MURAIPIXI-E4JF	A, B	MURAIPIXI-E4JF	A
PCIEX1_SLOT5	N/A		N/A	
PCIEX16_SLOT6	D1480	B	Third-party graphics hardware	-
PCIEX4_SLOT7	N/A		N/A	

Performance considerations with D-Series controller

Slot	Connectivity	Configuration 1	Configuration 2
PCIEX16_SLOT4	x8	B	A
PCIEX16_SLOT6	x16 / x8	A	B*

Note: * One Gen 3.0 PCIe x16 link (or two PCIe x16 slots with x8 link) – slot 4 and slot 6.

Option	Product
A	MURAI PXI-E4SF, MURAI PXI-E4SHF, MURAI PXI-D2MF, MURAI PXI-D2MHF, MURAI PXI-E2MF, MURAI PXI-E2MHF, MURAI PXI-D4JF, MURAI PXI-D4JHF, MURAI PXI-E4JF, or MURAI PXI-E4JHF
B	D1450 or D1480

Motherboard layout

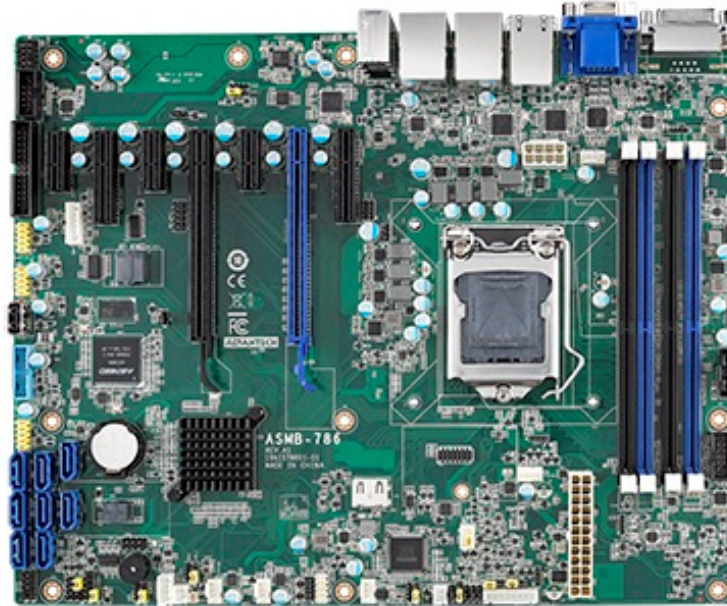

ECA EVS-540-ASMB-815

	D-Series based controllers	Third-party based controllers
Validated	Yes	No foreseeable compatibility issues

Maximum number of cards supported	5
Maximum supported Mura IPX Series	4
Maximum supported D-Series	4
Motherboard	Advantech ASMB-815 Part#: ASMB-815-00A1E / ASMB-815I-00A1E / ASMB-815T2-00A1E
Chipset	Intel C621 / C622
Processor	Intel® Xeon® Silver 4210R CPU @ 2.40 GHz
Heatsink (for CPU)	LGA 3647
System BIOS version	5.14, 2020-04-23
System memory	32 GB DDR4 ECC-RDIMM
Chassis	4U
Power supply	750 W
PCIe expansion slots	<ul style="list-style-type: none"> ▪ 2 PCIe x16 3.0 slots (x16 mechanical, x16 / x8 electrical) ▪ 3 PCIe x8 3.0 slots (x8 mechanical, x8 electrical) ▪ 1 PCIe x4 3.0 slot (x4 mechanical, x4 electrical)
Notes	<ul style="list-style-type: none"> ▪ Requires two 120 mm x 120 mm x 25 mm 120 CFM or 150 CFM chassis fans. ▪ The dust protection sponge filter in front of the chassis must be removed for proper system ventilation. ▪ The chassis fans must run at full speed. ▪ With 120 CFM fans: <ul style="list-style-type: none"> ▪ D1400 controller: The ambient temperature must not exceed 40 degrees centigrade. ▪ With 150 CFM fans: <ul style="list-style-type: none"> ▪ Wired mesh filter can be used in front of the chassis with 150 CFM fans only. ▪ Filter requires a 18 x 18 size 304 stainless steel wire mesh. ▪ In the system BIOS, select Socket Configuration → IIO Configuration, and change the following from [Auto] to [x8x8] only if the shared slots are fully populated: <ul style="list-style-type: none"> ▪ IOU1 (IIO PCIe Br2) [x8x8] ▪ IOU2 (IIO PCIe Br3) [x8x8] ▪ In the system BIOS, select Advanced → PCI Subsystem Settings, and make sure Above 4G Decoding is enabled. ▪ On-board console support with D-Series controller. Requires 3.05 or later drivers. ▪ Ensure to have the following settings for the GPU. In the system BIOS, go to Platform Configuration → PCH Devices: <ul style="list-style-type: none"> ▪ VGA Priority - Select Auto ▪ Onboard VGA Controller - Select Enable

Configurations

Slot	D-Series based controller		Third-party based controller	
	Main	Options	Main	Options
PCIEX1_Slot1	N/A		N/A	
PCIEX4_Slot2	N/A		N/A	
PCIEX8_Slot3	MURAIPIXI-E4JF	A	MURAIPIXI-E4JF	A
PCIEX16_Slot4	D1480	B	Third-party graphics hardware	-
PCIEX8_Slot5	MURAIPIXI-E4JF	A, B	MURAIPIXI-E4JF	A
PCIEX16_Slot6	D1480	B	Third-party graphics hardware	A
PCIEX8_Slot7	MURAIPIXI-E4JF	A, B	MURAIPIXI-E4JF	A

Performance considerations with D-Series controller

Slot	Connectivity	Configuration 1	Configuration 2
PCIEX1_Slot1	x1	N/A	N/A
PCIEX4_Slot2	x4	N/A	N/A
PCIEX8_Slot3	x8 / x0	A	A
PCIEX16_Slot4	x16 / x8	B*	B*
PCIEX8_Slot5	x8 / x0	A	A
PCIEX16_Slot6	x16 / x8	A	B*
PCIEX8_Slot7	x8	A	A

Note: * The GPU bandwidth is reduced to 6 GB/s instead of 12 GB/s when shared slots are used. Shared slots are 3 & 4 and 5 & 6.

Option	Product
A	MURAIPIXI-E4SF, MURAIPIXI-E4SHF, MURAIPIXI-D2MF, MURAIPIXI-D2MHF, MURAIPIXI-E2MF, MURAIPIXI-E2MHF, MURAIPIXI-D4JF, MURAIPIXI-D4JHF, MURAIPIXI-E4JF, or MURAIPIXI-E4JHF
B	D1450 or D1480

Motherboard layout

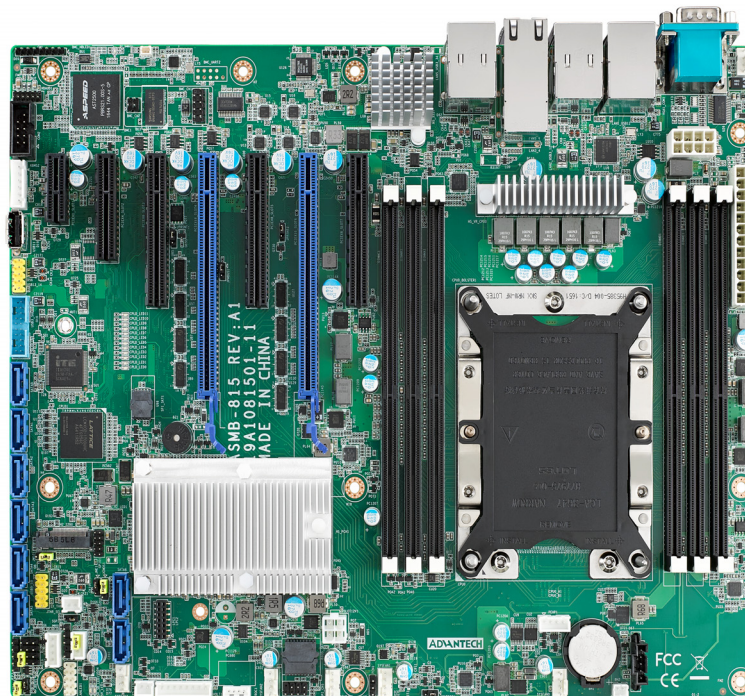

ECA EVS-540-C621E

	D-Series based controllers	Third-party based controllers
Validated	Yes	No foreseeable compatibility issues

Maximum number of cards supported	7
Maximum supported Mura IPX Series	6
Maximum supported D-Series	4
Motherboard	ASUS WS C621E Sage
Chipset	Intel C621
Processor	Intel® Xeon® Silver 4210R Dual CPU @ 2.40 GHz
Heatsink (for CPU)	LGA 3647
System BIOS version	6102, 2019-12-17
System memory	32 GB DDR4 ECC-RDIMM
Chassis	4U
Power supply	750 W redundant power supply
PCIe expansion slots	<ul style="list-style-type: none"> ▪ 3 PCIe x16 3.0 slots (x16 mechanical, x16 electrical) ▪ 2 PCIe x16 3.0 slots (x16 mechanical, x16 /x8 electrical) ▪ 2 PCIe x16 3.0 slot (x16 mechanical, x8 electrical)
Notes	<ul style="list-style-type: none"> ▪ Requires two 120 mm x120 mm x 25 mm 120 CFM or 150 CFM chassis fans running at full speed. ▪ The chassis fans are connected directly to the motherboard and must run at full speed. To change the fan speed, go to the system BIOS main page (EZ mode), select QFan Control, select the header to which the fans are connected, change from Standard to Full Speed, and apply the changes. ▪ Two dust protection sponge filters present on the front door and in front of the fans must be removed for proper system ventilation. ▪ With 120 CFM fans: <ul style="list-style-type: none"> ▪ D1400 controller: The ambient temperature must not exceed 35 degrees centigrade. ▪ With 150 CFM fans: <ul style="list-style-type: none"> ▪ Wired mesh filter can be used in front of the chassis with 150 CFM fans only and the ambient temperature must not exceed 35 degrees centigrade. ▪ Filter requires a 18 x 18 size 304 stainless steel wire mesh. ▪ To use the on-board graphics, make sure the 3-pin VGA_SW1 jumper is set to Enable on the motherboard. Then, install the VGA bracket cable that came with the motherboard in an empty slot and connect to the internal VGA connector VGA_HDR1 on the motherboard. ▪ In the system BIOS, go to Platform Configuration → Miscellaneous Configuration, then set Active Video to OFFboard. ▪ Ensure to have the following settings for Above 4G Decoding. In the system BIOS, go to Advanced → PCI Subsystem Configuration, then set Above 4G Decoding to Enabled, and set First VGA 4G Decode to Auto. ▪ On-board console support with D-Series controller. Requires 3.05 or later drivers.

Configurations

Slot	D-Series based controller		Third-party based controller	
	Main	Option	Main	Option
PCIEX16_1	D1480	B	Third-party graphics hardware	-
PCIEX16_2	MURAIPIXI-E4JHF	A	MURAIPIXI-E4JHF	A
PCIEX16_3	D1480	A, B	Third-party graphics hardware	A
PCIEX16_4	MURAIPIXI-E4JHF	A	MURAIPIXI-E4JHF	A
PCIEX16_5	D1480	A, B	Third-party graphics hardware	A
PCIEX16_6	MURAIPIXI-E4JHF	A	MURAIPIXI-E4JHF	A
PCIEX16_7	D1480	A, B	Third-party graphics hardware	A

Performance considerations with D-Series controller

Slot	Connectivity	Configuration 1	Configuration 2	Configuration 3	Configuration 4
PCIEX16_1	x16	B	B	B	B
PCIEX16_2	x8	A	A	A	A
PCIEX16_3	x16 / x8	A	A	A	B*
PCIEX16_4	x8 / x0	A	A	A	A
PCIEX16_5	x16	A	B	B	B
PCIEX16_6	x8	A	A	A	A
PCIEX16_7	x16	A	A	B	B

Note: * The GPU bandwidth is reduced to 6 GB/s instead of 12 GB/s when shared slots are used. Shared slots are 3 and 4.

Option	Product
A	MURAI PXI-E4SF, MURAI PXI-E4SHF, MURAI PXI-D2MF, MURAI PXI-D2MHF, MURAI PXI-E2MF, MURAI PXI-E2MHF, MURAI PXI-D4JF, MURAI PXI-D4JHF, MURAI PXI-E4JF, or MURAI PXI-E4JHF
B	D1450 or D1480

Motherboard layout

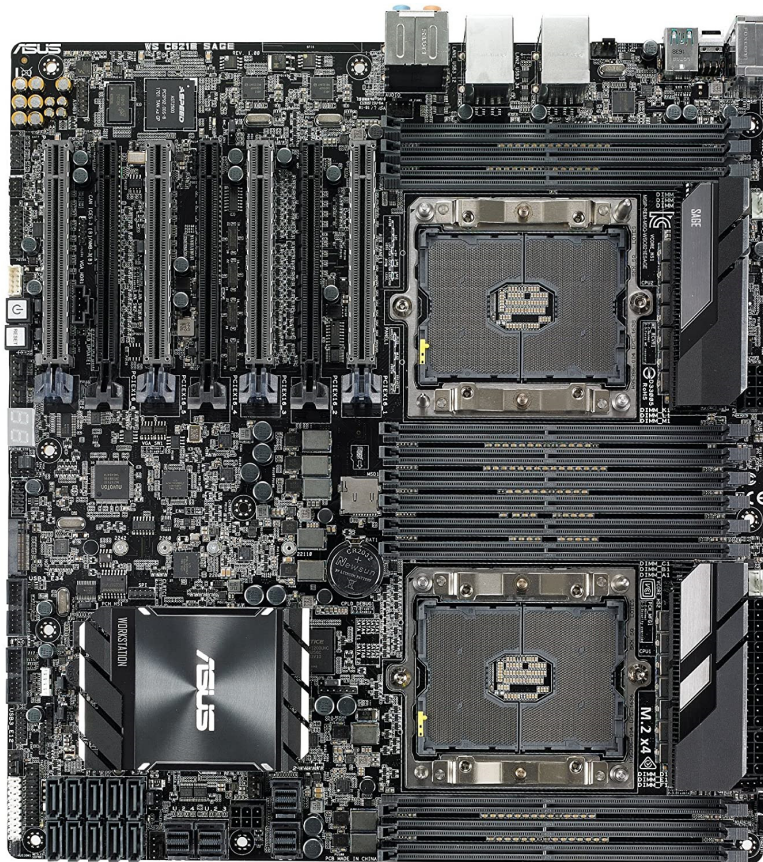

ECA EVS-540-X299

	D-Series based controllers	Third-party based controllers
Validated	Yes	No foreseeable compatibility issues

Maximum number of cards supported	7
Maximum supported Mura IPX Series	6
Maximum supported D-Series	4
Motherboard	ASUS Pro WS X299 SAGE II
Chipset	Intel X299
Processor	Intel® Core™ i9-10900X CPU @ 3.70 GHz (X-series, 48 lane CPU), or Intel® Core™ i7-9800X CPU @ 3.80 GHz (X-series 44 lane CPU), or Intel® Core™ i9-9920X CPU @3.50 GHz (X-series, 44 lane CPU)
Heatsink (for CPU)	LGA 2066
System BIOS version	0702, 2020-06-10
System memory	32 GB DDR4
Chassis	4U
Power supply	Advantech 750 W redundant power supply
PCIe expansion slots	<ul style="list-style-type: none"> 7 PCIe 3.0 / 2.0 x16 slots
Notes	<ul style="list-style-type: none"> Requires two 120 mm x 120 mm x 25 mm 120 CFM or 150 CFM chassis fans running at full speed. To change the chassis fan speed, go to the system BIOS main page (EZ mode) → Select QFan Control → select the header to which the fans are connected → change from Standard to Full Speed and apply the changes. Two dust protection sponge filters present on the front door and in front of the fans must be removed for proper system ventilation. With 120 CFM fans: <ul style="list-style-type: none"> D1400 controller: The ambient temperature must not exceed 35 degrees centigrade. With 150 CFM fans: <ul style="list-style-type: none"> Wired mesh filter can be used in front of the chassis with 150 CFM fans only and the ambient temperature must not exceed 35 degrees centigrade. Filter requires a 18 x18 size 304 stainless steel wire mesh. Ensure to have the following default settings for Above 4G Decoding. In the system BIOS, go to Advanced Mode → Boot, then set Above 4G Decoding to ON and set First VGA 4G Decode to Above_4G. Add-in board console support with D-Series controller. Requires 3.05 or later drivers.

Configurations

Slot	D-Series based controller		Third-party based controller	
	Main	Option	Main	Option
PCIEX16_1	D1480	B	Third-party graphics hardware	-
PCIEX16_2	MURAI PXI-D4JF	A	MURAI PXI-D4JF	A
PCIEX16_3	D1480	A, B	Third-party graphics hardware	A
PCIEX16_4	MURAI PXI-D4JF	A	MURAI PXI-D4JF	A
PCIEX16_5	D1480	A, B	Third-party graphics hardware	A
PCIEX16_6	MURAI PXI-D4JF	A, C	MURAI PXI-D4JF	A
PCIEX16_7	D1480	A, B	Third-party graphics hardware	A

Performance considerations with D-Series controller

Slot	Connectivity	Configuration 1	Configuration 2	Configuration 3	Configuration 4
PCIEX16_1	x16	B	B	B	B
PCIEX16_2	x8 / x4	A	A	A	A
PCIEX16_3	x16 / x8	A	A	B*	B*
PCIEX16_4	x8 / x0	A	A	A	A
PCIEX16_5	x16 / x8	A	B*	B*	B*
PCIEX16_6	x8 / x0	A	A	A	A
PCIEX16_7	x16 / x8	A	A	A	B*

Note: * The D-Series bandwidth is reduced to 6 GB/s instead of 12 GB/s when shared slots are used. However, the performance depends on the layout, the number of streams going to each D-Series, rendering done, and the intended usage. Shared slots are 2&3, 4&5, and 6&7.

Option	Product
A	MURAIPIXI-E4SF, MURAIPIXI-E4SHF, MURAIPIXI-D2MF, MURAIPIXI-D2MHF, MURAIPIXI-E2MF, MURAIPIXI-E2MHF, MURAIPIXI-D4JF, MURAIPIXI-D4JHF, MURAIPIXI-E4JF, or MURAIPIXI-E4JHF
B	D1450 or D1480
C	Matrox M9148 LP PCIe x16, Matrox M9140 LP PCIe x16, Matrox M9138 LP PCIe x16, Matrox M9128 LP PCIe x16, Matrox M9120 Plus LP PCIe x16, Matrox M9120 Plus LP PCIe x1, Matrox M9120 PCIe x16, NVIDIA Quadro P620, NVIDIA Quadro P600, NVIDIA Quadro P400, NVIDIA Quadro K620, AMD Radeon WX2100, or AMD Radeon Vega 8 (add-in card console options)

Motherboard layout

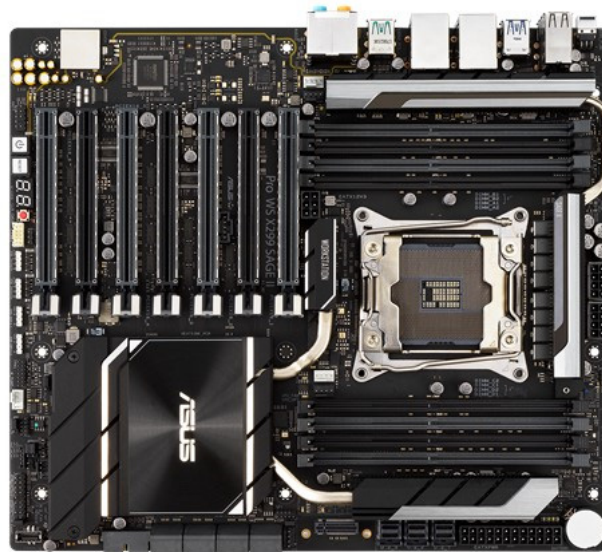

ECA EVS-840

	D-Series based controllers	Third-party based controllers
Validated	Yes	No foreseeable compatibility issues

Maximum number of cards supported	10
Maximum supported Mura IPX Series	9
Maximum supported D-Series	4
Motherboard	Advantech PCE-7131 (SHB) Advantech PCE-5B12-00A1 (Backplane)
Chipset	Intel C246
Processor	Intel® Xeon® E-2278GE CPU @ 3.30 GHz or Intel® Core™ i7-9700E CPU @ 2.60 GHz
Heatsink (for CPU)	2U CPU cooler
System BIOS version	5.13, 2020-04-09
System memory	32 GB DDR4 ECC Memory (Intel Xeon E-2278GE) 32 GB DDR4 non-ECC memory (Intel i7-9700E)
Chassis	5U (Part#: GHI-528)
Power supply	1550 W redundant power supply (Part#: Zippy MTW4-5F50V3H)
PCIe expansion slots	<ul style="list-style-type: none"> ▪ 10 PCIe x16 2.0 slots (x16 mechanical, x16 electrical) ▪ 1 PCIe x16 2.0 slot (x16 mechanical, x4 electrical)
Notes	<ul style="list-style-type: none"> ▪ The dust protection sponge filter in the front door must be removed for proper system ventilation. ▪ If you use a wired mesh filter in the front door, the ambient temperature must not exceed 40 degrees C. The chassis fans must run at full speed. Filter requires a 18 x18 size 304 stainless steel wire mesh. ▪ Once the add-in cards are installed in the system, the baffle must be placed on the top for proper air circulation. The baffle must be used only with small clips to properly secure the add-in cards with the board retainer bar. ▪ Requires 4 x 92 mm x 92 mm x 25 mm 102 CFM chassis fans running at full speed. ▪ The smart fan must be disabled to run the chassis fans at full speed. In the system BIOS, go to Advanced → HW Monitor Tab → SYSFAN1 smartfan setting → and select DISABLE. ▪ Ensure to have the following settings for GPU. Go to the system BIOS main page → Chipset → System Agent (SA) Configuration → Graphics Configuration → and select: <ul style="list-style-type: none"> ▪ Primary Display → AUTO ▪ Internal Graphics → AUTO (select Enabled for Console) ▪ In the system BIOS main page, go to → Chipset → System Agent (SA) Configuration → Above 4GB MMIO BIOS Assignment → and select Enabled. ▪ On-board console support with D-Series controller. Requires 3.05 or later drivers. ▪ Card placement shown in the configuration table must be followed for better system ventilation. ▪ Any unused slots must be installed with solid brackets for proper system ventilation. ▪ Requires a CPU 8-pin female to ATX 4-pin male power adapter to connect the power supply to the 4-pin connector header ATX12V2 on the backplane.

Configurations

Slot	D-Series based controller		Third-party based controller	
	Main	Option	Main	Option
PPCIEX4_1	N/A		N/A	
P1PCIEX16_1	MURAIPIXI-E4JF	A	Third-party graphics hardware	-
P1PCIEX16_2	MURAIPIXI-E4JF	A	MURAIPIXI-E4JF	A
P1PCIEX16_3	MURAIPIXI-E4JF	A	MURAIPIXI-E4JF	A
P1PCIEX16_4	D1480	B	Third-party graphics hardware	A
P1PCIEX16_5	MURAIPIXI-E4JF	A	MURAIPIXI-E4JF	A

Slot	D-Series based controller		Third-party based controller	
	Main	Option	Main	Option
P2PCIEX16_1	MURAI PXI-E4JF	A	Third-party graphics hardware	A
P2PCIEX16_2	MURAI PXI-E4JF	A	MURAI PXI-E4JF	A
P2PCIEX16_3	D1480	B	MURAI PXI-E4JF	A
P2PCIEX16_4	D1480	B	Third-party graphics hardware	A
P2PCIEX16_5	D1480	B	MURAI PXI-E4JF	A

Performance considerations with D-Series controller

Slot	Connectivity	Configuration 1	Configuration 2	Configuration 3	Configuration 4
PPCIEX4_1	x4	N/A	-	-	-
P1PCIEX16_1	x16	A	-	-	-
P1PCIEX16_2	x16	A	-	-	-
P1PCIEX16_3	x16	A	-	-	-
P1PCIEX16_4	x16	B*	-	-	-
P1PCIEX16_5	x16	A	-	-	-
P2PCIEX16_1	x16	A	-	-	-
P2PCIEX16_2	x16	A	-	-	-
P2PCIEX16_3	x16	B*	-	-	-
P2PCIEX16_4	x16	B*	-	-	-
P2PCIEX16_5	x16	B*	-	-	-

Note: * The backplane has a single PCIe x16 Gen2 connection to the CPU.

* The maximum stream bandwidth to a single GPU is limited to 6 GB/s.

Option	Product
A	MURAI PXI-E4SF, MURAI PXI-E4SHF, MURAI PXI-D2MF, MURAI PXI-D2MHF, MURAI PXI-E2MF, MURAI PXI-E2MHF, MURAI PXI-D4JF, MURAI PXI-D4JHF, MURAI PXI-E4JF, or MURAI PXI-E4JHF
B	D1450 or D1480

Motherboard layout

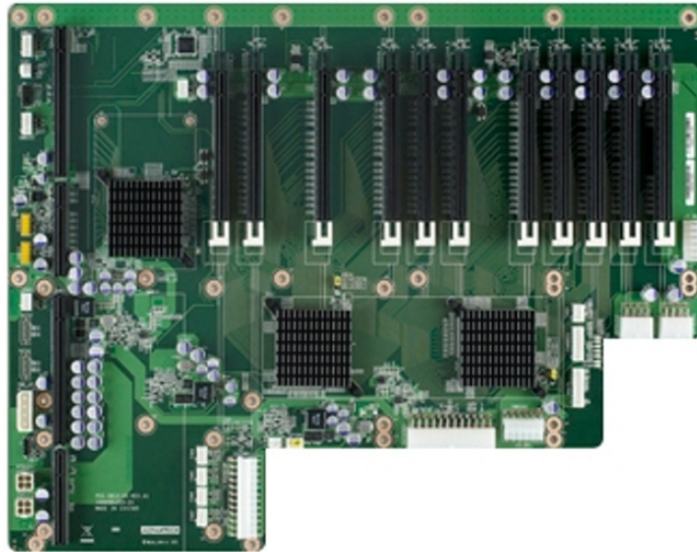

ECA EVS-XL

	D-Series based controllers	Third-party based controllers
Validated	Yes	No foreseeable compatibility issues

Maximum number of cards supported	14
Maximum supported Mura IPX Series	13
Maximum supported D-Series	4
Motherboard	Advantech PCE-7131 (SHB) Advantech PCE-5B12-00A1 (Backplane)
Chipset	Intel C246
Processor	Intel® Xeon® E-2278GE CPU @ 3.30 GHz, or Intel® Core™ i7-9700E CPU @ 2.60 GHz
Heatsink (for CPU)	2U CPU cooler
System BIOS version	5.13, 2020-04-09
System memory	32 GB DDR4 ECC Memory (Intel Xeon E-2278GE) 32 GB DDR4 non-ECC memory (Intel i7-9700E)
Chassis	5U (Part#: GHI-528)
Power supply	1550 W redundant power supply (Part#: Zippy MTW4-5F50V3H)
PCIe expansion slots	<ul style="list-style-type: none"> ▪ 17 PCIe x16 3.0 slots (x16 mechanical, x16 electrical) ▪ 1 PCIe x16 3.0 slot (x16 mechanical, x4 electrical)
Notes	<ul style="list-style-type: none"> ▪ The dust protection sponge filter in the front door must be removed for proper system ventilation. ▪ If you use a wired mesh filter in the front door, the filter requires a 18 x18 size 304 stainless steel wire. ▪ Once the add-in cards are installed in the system, the baffle must be placed on the top for proper air circulation. The baffle must be used only with small clips to properly secure the add-in cards with the board retainer bar. ▪ Requires 4 x 92 mm x 92 mm x 25 mm 118 CFM chassis fans running at full speed. ▪ The smart fan must be disabled to run the chassis fans at full speed. In the system BIOS, go to Advanced → HW Monitor Tab → SYSFAN1 smartfan setting → and select DISABLE. ▪ Ensure to have the following settings for GPU. Go to the system BIOS main page → Chipset → System Agent (SA) Configuration → Graphics Configuration → and select: <ul style="list-style-type: none"> ▪ Primary Display → AUTO ▪ Internal Graphics → AUTO (select Enabled for Console) ▪ In the system BIOS main page, go to Chipset → System Agent (SA) Configuration → Above 4GB MMIO BIOS Assignment → and select Enabled. ▪ The P1PCIE1 x4 slot is unusable due to adjacent SHB slot. ▪ The P2PCIE1 x16 and P2PCIE2x16 slots are unusable due to mechanical conflict with the SHB CPU fan. ▪ The P5PCIE5 x16 slot is unusable due to the presence of the red push button in the bracket slot area. ▪ Card placement shown in the configuration table must be followed for better system ventilation. ▪ Any unused slots must be installed with solid brackets for proper system ventilation. ▪ On-board console support with D-Series controller. Requires 3.05 or later drivers.

Configurations

Slot	D-Series based controller		Third-party based controller	
	Main	Option	Main	Option
P1PCIE_1	N/A		N/A	
P2PCIE_1	N/A		N/A	
P2PCIE_2	N/A		N/A	
P3PCIE_1	MURAI PXI-E4JF	A	Third-party graphics hardware	-
P3PCIE_2	MURAI PXI-E4JF	A	MURAI PXI-E4JF	A
P3PCIE_3	MURAI PXI-E4JF	A	MURAI PXI-E4JF	A

Slot	D-Series based controller		Third-party based controller	
	Main	Option	Main	Option
P3PCIE_4	MURAI PXI-E4JF	A	MURAI PXI-E4JF	A
P3PCIE_5	MURAI PXI-E4JF	A	Third-party graphics hardware	A
P4PCIE_1	MURAI PXI-E4JF	A	MURAI PXI-E4JF	A
P4PCIE_2	MURAI PXI-E4JF	A	MURAI PXI-E4JF	A
P4PCIE_3	MURAI PXI-E4JF	A	MURAI PXI-E4JF	A
P4PCIE_4	MURAI PXI-E4JF	A	MURAI PXI-E4JF	A
P4PCIE_5	MURAI PXI-E4JF	A	Third-party graphics hardware	A
P5PCIE_1	D1480	B	MURAI PXI-E4JF	A
P5PCIE_2	D1480	B	MURAI PXI-E4JF	A
P5PCIE_3	D1480	B	MURAI PXI-E4JF	A
P5PCIE_4	D1480	B	Third-party graphics hardware	A
P5PCIE_5	N/A		N/A	

Performance considerations with D-Series controller

Slot	Connectivity	Configuration 1	Configuration 2	Configuration 3	Configuration 4
P1PCIE_1	x4	N/A	-	-	-
P2PCIE_1	x16	N/A	-	-	-
P2PCIE_2	x16	N/A	-	-	-
P3PCIE_1	x16	A	-	-	-
P3PCIE_2	x16	A	-	-	-
P3PCIE_3	x16	A	-	-	-
P3PCIE_4	x16	A	-	-	-
P3PCIE_5	x16	A	-	-	-
P4PCIE_1	x16	A	-	-	-
P4PCIE_2	x16	A	-	-	-
P4PCIE_3	x16	A	-	-	-
P4PCIE_4	x16	A	-	-	-
P4PCIE_5	x16	A	-	-	-
P5PCIE_1	x16	B	-	-	-
P5PCIE_2	x16	B	-	-	-
P5PCIE_3	x16	B	-	-	-
P5PCIE_4	x16	B	-	-	-
P5PCIE_5	x16	N/A	-	-	-

Note: * The backplane has a single PCIe x16 Gen3 connection to the CPU.

* The maximum stream bandwidth is limited to 12 GB/s.

Option	Product
A	MURAI PXI-E4SF, MURAI PXI-E4SHF, MURAI PXI-D2MF, MURAI PXI-D2MHF, MURAI PXI-E2MF, MURAI PXI-E2MHF, MURAI PXI-D4JF, MURAI PXI-D4JHF, MURAI PXI-E4JF, or MURAI PXI-E4JHF
B	D1450 or D1480

Motherboard layout

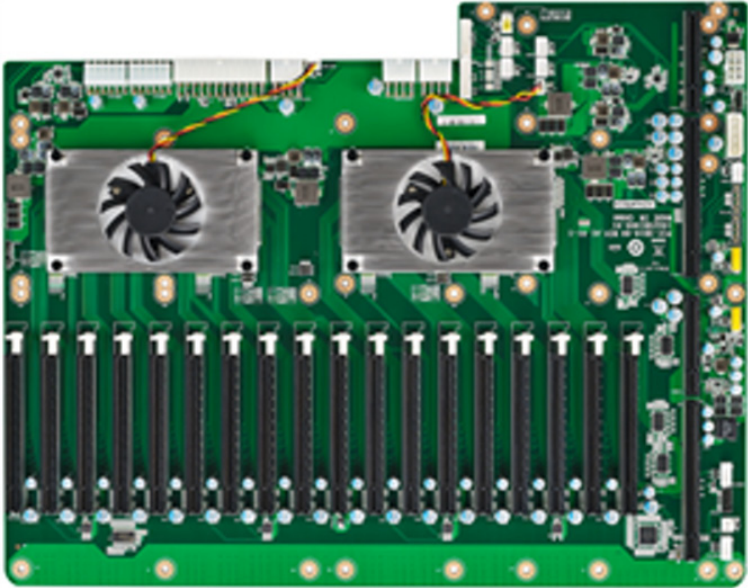

GridVue GV-A427

	D-Series based controllers	Third-party based controllers
Validated	Yes	No foreseeable compatibility issues

Maximum number of cards supported	7
Maximum supported Mura IPX Series	6
Maximum supported D-Series	4
Motherboard	ASUS WS C422 SAGE/10G
Chipset	Intel® C422
Processor	Intel® Xeon® W-2123 CPU @ 3.6 GHz
Heatsink (for CPU)	LGA2066
System BIOS version	3405, 3/22/2021
System memory	32 GB DDR4
Chassis	4U (Part#: PCICase IPC-C4FB-H)
Power supply	800 W redundant power supply (Part#: PIST1080-EPSh-80)
PCIe expansion slots	<ul style="list-style-type: none"> 7 PCIe x16 3.0 slots (x16 mechanical, x16 / x8 electrical)
Notes	<ul style="list-style-type: none"> Requires 3 x 92 mm x 92 mm x 38 mm 141 CFM middle chassis fans (Sanyo Denki Part#: 9GA0912P1H03). Ensure to have the following settings for Above 4G Decoding in the system BIOS: <ul style="list-style-type: none"> Go to Advanced Mode → Boot, then set Above 4G Decoding to ON, and set First VGA 4G Decode to Above_4G. Go to Advanced Mode → PCI Subsystem Settings, then set Above 4G Decoding to ENABLED.

Configurations

Slot	D-Series based controller		Third-party based controller	
	Main	Option	Main	Option
PCIEX16_1	D1480	B	Third-party graphics hardware	-
PCIEX16_2	MURAIPIXI-E4JHF	A	MURAIPIXI-E4JHF	A
PCIEX16_3	D1480	A, B	Third-party graphics hardware	A
PCIEX16_4	MURAIPIXI-E4JHF	A	MURAIPIXI-E4JHF	A
PCIEX16_5	D1480	A, B	Third-party graphics hardware	A
PCIEX16_6	MURAIPIXI-E4JHF	A	MURAIPIXI-E4JF	A
PCIEX16_7	D1480	A, B	Third-party graphics hardware	A

Performance considerations with D-Series controller

Slot	Connectivity	Configuration 1	Configuration 2	Configuration 3	Configuration 4
PCIEX16_1	x16	B	B	B	B
PCIEX16_2	x4 / x8	A	A	A	A
PCIEX16_3	x16 / x8	A	A	B*	B*
PCIEX16_4	x0 / x8	A	A	A	A
PCIEX16_5	x16 / x8	A	B*	B*	B*
PCIEX16_6	x0 / x8	A	A	A	A
PCIEX16_7	x16 / x8	A	A	A	B*

Note: * The GPU bandwidth is reduced to 6 GB/s instead of 12 GB/s when shared slots are used. Shared slots are 2 & 3, 4 & 5, and 6 & 7.

Option	Product
A	MURAIPIXI-E4SF, MURAIPIXI-E4SHF, MURAIPIXI-D2MF, MURAIPIXI-D2MHF, MURAIPIXI-E2MF, MURAIPIXI-E2MHF, MURAIPIXI-D4JF, MURAIPIXI-D4JHF, MURAIPIXI-E4JF, or MURAIPIXI-E4JHF
B	D1450 or D1480

Motherboard layout

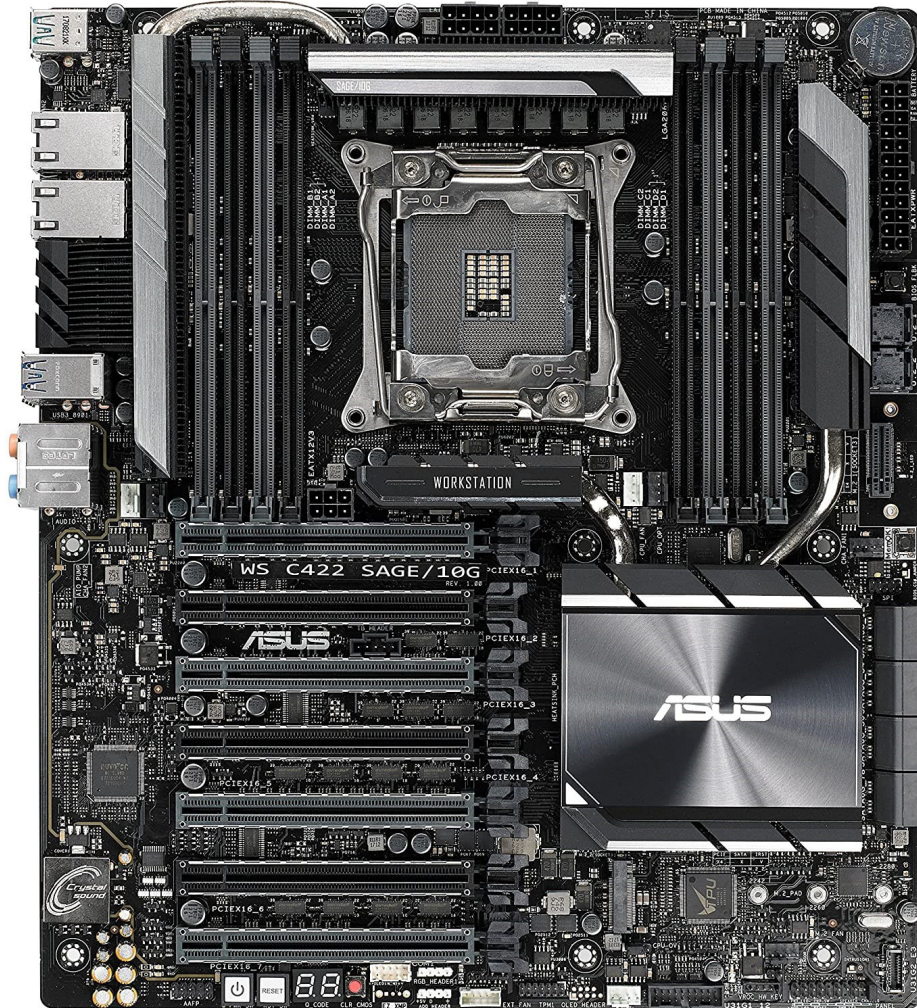

GridVue GV-G714

	D-Series based controllers	Third-party based controllers
Validated	Yes	No foreseeable compatibility issues

Maximum number of cards supported	14
Maximum supported Mura IPX Series	13
Maximum supported D-Series	4
Motherboard	Advantech PCE-7131 (SHB) Advantech PCE-5B19 (Backplane)
Chipset	Intel® C246
Processor	Intel® Xeon® E-2278GE CPU @ 3.30 GHz, or Intel® Core™ i7-9700E CPU @ 2.60 GHz
Heatsink (for CPU)	2U CPU cooler
System BIOS version	5.13, 2020-04-09
System memory	32 GB ECC memory (Intel Xeon E-2278GE) 32 GB non-ECC memory (Intel i7-9700E)
Chassis	5U (Part#: GHI-528)
Power supply	1550 W redundant power supply (Part#: Zippy MTW4-5F50V3H)
PCIe expansion slots	<ul style="list-style-type: none"> ▪ 17 PCIe x16 3.0 slots (x16 mechanical, x16 electrical) ▪ 1 PCIe x16 3.0 slot (x16 mechanical, x4 electrical)
Notes	<ul style="list-style-type: none"> ▪ The dust protection sponge filter in the front door must be removed for proper system ventilation. ▪ If you use a wired mesh filter in the front door, the filter requires a 18 x18 size 304 stainless steel wire. ▪ Baffle must be used along with small clips to properly secure the add-in cards with the hold down bar. ▪ Requires 4 x 92 mm x 92 mm x 25 mm 118 CFM chassis fans running at full speed. ▪ The smart fan must be disabled to run the chassis fans at full speed. In the system BIOS, go to Advanced → HW Monitor Tab → SYSFAN1 smartfan setting → and select DISABLE. ▪ Ensure to have the following settings for GPU. Go to the system BIOS main page → Chipset → System Agent (SA) Configuration → Graphics Configuration → and select: <ul style="list-style-type: none"> ▪ Primary Display → AUTO ▪ Internal Graphics → AUTO (select Enabled for Console) ▪ In the system BIOS main page, go to Chipset → System Agent (SA) Configuration → Above 4GB MMIO BIOS Assignment → and select Enabled. ▪ The P1PCIE1 x4 slot is unusable due to adjacent SHB slot. ▪ The P2PCIE1 x16 and P2PCIE2x16 slots are unusable due to mechanical conflict with the SHB CPU fan. ▪ The P5PCIE5 x16 slot is unusable due to the presence of the red push button in the bracket slot area. ▪ Card placement shown in the configuration table must be followed for better system ventilation. ▪ Any unused slots must be installed with solid brackets for proper system ventilation. ▪ On-board console support with D-Series controller. Requires 3.05 or later drivers.

Configurations

Slot	D-Series based controller		Third-party based controller	
	Main	Option	Main	Option
P1PCIE_1	N/A		N/A	
P2PCIE_1	N/A		N/A	
P2PCIE_2	N/A		N/A	
P3PCIE_1	MURAIPIXI-E4JF	A	Third-party graphics hardware	-
P3PCIE_2	MURAIPIXI-E4JF	A	MURAIPIXI-E4JF	A
P3PCIE_3	MURAIPIXI-E4JF	A	MURAIPIXI-E4JF	A
P3PCIE_4	MURAIPIXI-E4JF	A	MURAIPIXI-E4JF	A

Slot	D-Series based controller		Third-party based controller	
	Main	Option	Main	Option
P3PCIE_5	MURAI PXI-E4JF	A	Third-party graphics hardware	A
P4PCIE_1	MURAI PXI-E4JF	A	MURAI PXI-E4JF	A
P4PCIE_2	MURAI PXI-E4JF	A	MURAI PXI-E4JF	A
P4PCIE_3	MURAI PXI-E4JF	A	MURAI PXI-E4JF	A
P4PCIE_4	MURAI PXI-E4JF	A	MURAI PXI-E4JF	A
P4PCIE_5	MURAI PXI-E4JF	A	Third-party graphics hardware	A
P5PCIE_1	D1480	B	MURAI PXI-E4JF	A
P5PCIE_2	D1480	B	MURAI PXI-E4JF	A
P5PCIE_3	D1480	B	MURAI PXI-E4JF	A
P5PCIE_4	D1480	B	Third-party graphics hardware	A
P5PCIE_5	N/A		N/A	

Performance considerations with D-Series controller

Slot	Connectivity	Configuration 1	Configuration 2	Configuration 3	Configuration 4
P1PCIE_1	x4	N/A	-	-	-
P2PCIE_1	x16	N/A	-	-	-
P2PCIE_2	x16	N/A	-	-	-
P3PCIE_1	x16	A	-	-	-
P3PCIE_2	x16	A	-	-	-
P3PCIE_3	x16	A	-	-	-
P3PCIE_4	x16	A	-	-	-
P3PCIE_5	x16	A	-	-	-
P4PCIE_1	x16	A	-	-	-
P4PCIE_2	x16	A	-	-	-
P4PCIE_3	x16	A	-	-	-
P4PCIE_4	x16	A	-	-	-
P4PCIE_5	x16	A	-	-	-
P5PCIE_1	x16	B	-	-	-
P5PCIE_2	x16	B	-	-	-
P5PCIE_3	x16	B	-	-	-
P5PCIE_4	x16	B	-	-	-
P5PCIE_5	x16	N/A	-	-	-

Note: * The backplane has a single PCIe x16 Gen3 connection to the CPU.

* The maximum stream bandwidth is limited to 12 GB/s.

Option	Product
A	MURAI PXI-E4SF, MURAI PXI-E4SHF, MURAI PXI-D2MF, MURAI PXI-D2MHF, MURAI PXI-E2MF, MURAI PXI-E2MHF, MURAI PXI-D4JF, MURAI PXI-D4JHF, MURAI PXI-E4JF, or MURAI PXI-E4JHF
B	D1450 or D1480

Motherboard layout

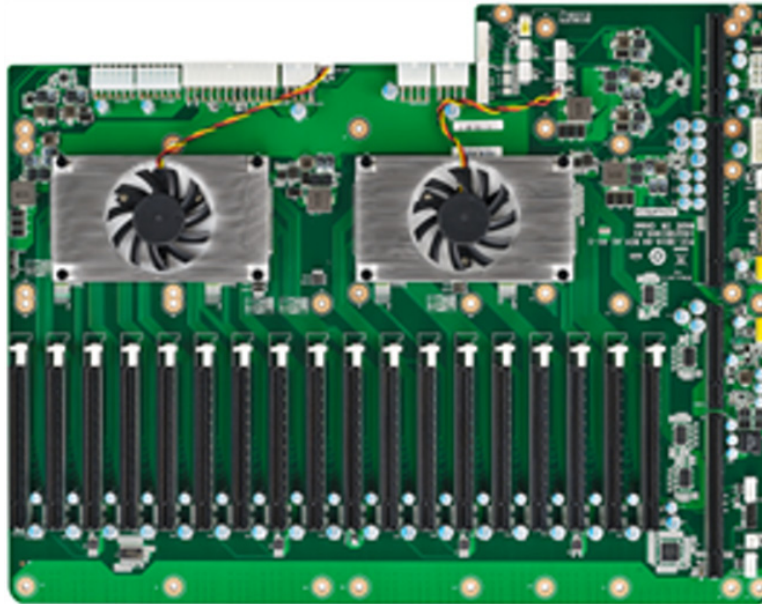

GridVue GV-S427

	D-Series based controllers	Third-party based controllers
Validated	Yes	No foreseeable compatibility issues

Maximum number of cards supported	7
Maximum supported Mura IPX Series	6
Maximum supported D-Series	4
Motherboard	ASUS WS C422 SAGE/10G
Chipset	Intel® C422
Processor	Intel® Xeon® W-2123 CPU @ 3.6GHz
Heatsink (for CPU)	LGA2066
System BIOS version	3405, 3/22/2021
System memory	32 GB DDR4
Chassis	4U (Part#: Supermicro CSE-842XTQC-R804B)
Power supply	800 W redundant power supply
PCIe expansion slots	<ul style="list-style-type: none"> 7 PCIe ×16 3.0 slots (×16 mechanical, ×16 / ×8 electrical)
Notes	<ul style="list-style-type: none"> The chassis fans must be set to run at standard speed. Ensure to have the following settings for Above 4G Decoding in the system BIOS: <ul style="list-style-type: none"> Go to Advanced Mode → Boot, then set Above 4G Decoding to ON, and set First VGA 4G Decode to Above_4G. Go to Advanced Mode → PCI Subsystem Settings, then set Above 4G Decoding to ENABLED.

Configurations

Slot	D-Series based controller		Third-party based controller	
	Main	Option	Main	Option
PCIEX16_1	D1480	B	Third-party graphics hardware	-
PCIEX16_2	MURAI PXI-E4JHF	A	MURAI PXI-E4JHF	A
PCIEX16_3	D1480	A, B	Third-party graphics hardware	A
PCIEX16_4	MURAI PXI-E4JHF	A	MURAI PXI-E4JHF	A
PCIEX16_5	D1480	A, B	Third-party graphics hardware	A
PCIEX16_6	MURAI PXI-E4JHF	A	MURAI PXI-E4JF	A
PCIEX16_7	D1480	A, B	Third-party graphics hardware	A

Performance considerations with D-Series controller

Slot	Connectivity	Configuration 1	Configuration 2	Configuration 3	Configuration 4
PCIEX16_1	x16	B	B	B	B
PCIEX16_2	x4 / x8	A	A	A	A
PCIEX16_3	x16 / x8	A	A	B*	B*
PCIEX16_4	x0 / x8	A	A	A	A
PCIEX16_5	x16 / x8	A	B*	B*	B*
PCIEX16_6	x0 / x8	A	A	A	A
PCIEX16_7	x16 / x8	A	A	A	B*

Note: * The GPU bandwidth is reduced to 6 GB/s instead of 12 GB/s when shared slots are used. Shared slots are 2 & 3, 4 & 5, and 6 & 7.

Option	Product
A	MURAI PXI-E4SF, MURAI PXI-E4SHF, MURAI PXI-D2MF, MURAI PXI-D2MHF, MURAI PXI-E2MF, MURAI PXI-E2MHF, MURAI PXI-D4JF, MURAI PXI-D4JHF, MURAI PXI-E4JF, or MURAI PXI-E4JHF
B	D1450 or D1480

Motherboard layout

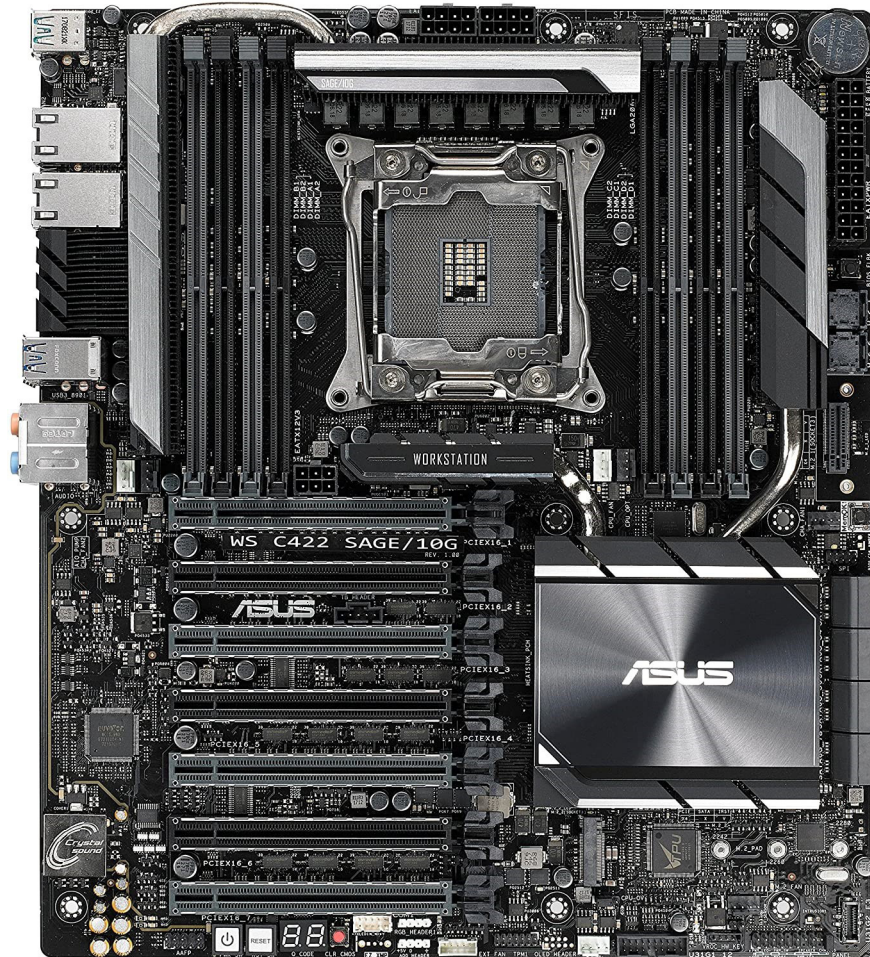

HP ZCentral 4R Workstation

	D-Series based controllers	Third-party based controllers
Validated	Yes	No foreseeable compatibility issues

Maximum number of cards supported	3
Maximum supported Mura IPX Series	2
Maximum supported D-Series	3
Motherboard	HP ZCentral 4R WS
Chipset	Intel C422
Processor	Intel® Xeon® W-2223 CPU, @ 3.60 GHz
Heatsink (for CPU)	LGA 2066R4
System BIOS version	HP P63 v01.06, 2020-10-28
System memory	32 GB DDR4 ECC RDIMM
Chassis	1U
Power supply	675 W Single / Redundant PSU
PCIe expansion slots	Single slot riser: <ul style="list-style-type: none"> ▪ 1 PCIe x16 3.0 slot Dual slot riser: <ul style="list-style-type: none"> ▪ 1PCIe x16 3.0 slot (x16 mechanical, x16 / x8 electrical) ▪ 1PCIe x16 3.0 slot (16 mechanical, x8 electrical)

Configurations

Slot	D-Series based controller		Third-party based controller	
	Main	Option	Main	Option
SSR SLOT1 PCIe3x16	D1480	B	Third-party graphics hardware	-
DSR SLOT2 PCIe3x16/8*	D1480	A, B	Third-party graphics hardware	A
DSR SLOT3 PCIe3x8	MURAIPIXI-E4JHF	A, B	MURAIPIXI-E4JHF	A

Note: DSR Slot 2 operates at x8 if DSR Slot 3 is populated.

Performance considerations with D-Series controller

Slot	Connectivity	Configuration 1	Configuration 2
SSR SLOT1 PCIe3x16	x16	A	A
DSR SLOT2 PCIe3x16/8	x16 / 8	B	B*
DSR SLOT3 PCIe3x8	x8	N/A	N/A

Note: GPU bandwidth reduced to 6 GB/s instead of 12 GB/s when DSR Slot3 is populated.

Option	Product
A	MURAIPIXI-E4SF, MURAIPIXI-E4SHF, MURAIPIXI-D2MF, MURAIPIXI-D2MHF, MURAIPIXI-E2MF, MURAIPIXI-E2MHF, MURAIPIXI-D4JF, MURAIPIXI-D4JHF, MURAIPIXI-E4JF, or MURAIPIXI-E4JHF
B	D1450 or D1480

Lenovo Thinkstation P520

	D-Series based controllers	Third-party based controllers
Validated	Yes	No foreseeable compatibility issues
Maximum number of cards supported	4	
Maximum supported Mura IPX Series	2	
Maximum supported D-Series	3	
Motherboard	Lenovo P520	
Chipset	Intel C422	
Processor	Intel® Xeon® W-2102 CPU, @ 2.90 GHz	
Heatsink (for CPU)	LGA 2066	
System BIOS version	LENOVO S03KT44A, 2021-01-21	
System memory	32 GB ECC RDIMM	
Chassis	Lenovo P520	
Power supply	690 W	
PCIe expansion slots	<ul style="list-style-type: none"> ▪ 2 PCIe x16 3.0 slots ▪ 1 PCIe x8 3.0 slot ▪ 2 PCIe x4 3.0 slots 	
Notes	<ul style="list-style-type: none"> ▪ In the system BIOS, go to Device → Video Setup → select Active Video = Auto. ▪ The system fan speed must be set at full speed for proper thermal ventilation. In the system BIOS, go to Power → Fan Control Stepping → select 7-Higher fan speed. ▪ In the system BIOS, go to Advanced → PCIe/PCI settings → Above 4G decoding → select Enabled. ▪ The ambient temperature must not exceed 35 degrees centigrade. 	

Configurations

Slot	D-Series based controller		Third-party based controller	
	Main	Option	Main	Option
SLOT1 X8 GEN3	MURAIPIXI-E4JHF	A	MURAIPIXI-E4JHF	A
SLOT2 X16 GEN3	D1480	B	Third-party graphics hardware	-
SLOT3 X4 GEN3	N/A		N/A	
SLOT4 X16 GEN3	D1480	A, B	Third-party graphics hardware	A
SLOT5 (PCI)	N/A		N/A	
SLOT6 X4 GEN3	Console	C	N/A	

Performance considerations with D-Series controller

Slot	Connectivity	Configuration 1	Configuration 2
SLOT1 X8 GEN3	x8	A	A
SLOT2 X16 GEN3	x16	B	B
SLOT3 x4 GEN3	x4	N/A	N/A
SLOT4 x16 GEN3	x16	A	B
SLOT5 (PCI)	-	N/A	N/A
SLOT6 x4 GEN3	x4	C	C

Note: Slot 6 PCIe lanes connect through IOH. Performance may be reduced.

Option	Product
A	MURAI PXI-E4SF, MURAI PXI-E4SHF, MURAI PXI-D2MF, MURAI PXI-D2MHF, MURAI PXI-E2MF, MURAI PXI-E2MHF, MURAI PXI-D4JF, MURAI PXI-D4JHF, MURAI PXI-E4JF, or MURAI PXI-E4JHF
B	D1450 or D1480
C	Matrox M9148 LP PCIe x16, Matrox M9140 LP PCIe x16, Matrox M9138 LP PCIe x16, Matrox M9128 LP PCIe x16, Matrox M9120 Plus LP PCIe x16, Matrox M9120 Plus LP PCIe x1, Matrox M9120 PCIe x16, NVIDIA Quadro P620, NVIDIA Quadro P600, NVIDIA Quadro P400, NVIDIA Quadro K620, NVIDIA GeForce GT710, AMD Radeon WX2100, or AMD Radeon Vega 8 (add-in card console options)

Lenovo Thinkstation P620

	D-Series based controllers	Third-party based controllers
Validated	Yes	No foreseeable compatibility issues

Maximum number of cards supported	6
Maximum supported Mura IPX Series	5
Maximum supported D-Series	4
Motherboard	Lenovo P620
Chipset	AMD WRX80
Processor	AMD Ryzen™ Threadripper™ Pro 3945WX @ 4.0 GHz
Heatsink (for CPU)	sWRX4
System BIOS version	LENOVO S07KT17A, 2021-01-11
System memory	64 GB DDR4 ECC RDIMM
Chassis	Lenovo P620
Power supply	1000 W
PCIe expansion slots	<ul style="list-style-type: none"> ▪ 4 PCIe x16 4.0 slots ▪ 2 PCIe x8 4.0 slots
Notes	<ul style="list-style-type: none"> ▪ To use a console, the add-in card must be set to primary video as follows: In the system BIOS, go to Device → Video Setup → select Active Video → then select the PCIe slot where the console is installed. ▪ The system fan speed must be set at full speed for proper ventilation. In the system BIOS, go to Power → Fan Control Stepping → select 7-Higher fan speed. ▪ In the system BIOS, make sure you have the following setting: Advanced → Common RefCode Configuration → MMIO Above 4G Limit → AUTO. ▪ The ambient temperature must not exceed 35 degrees centigrade. ▪ Console support with D-Series controller. Requires 3.05 or later drivers. ▪ Add-in board console support is limited to NVIDIA GeForce GT710.

Configurations

Slot	D-Series based controller		Third-party based controller	
	Main	Option	Main	Option
SLOT1 X16 GEN4	D1480	B	Third-party graphics hardware	-
SLOT2 X8 GEN4	MURAIPIXI-E4JHF	A	MURAIPIXI-E4JHF	A
SLOT3 X16 GEN4	D1480	A, B	Third-party graphics hardware	A
SLOT4 X16 GEN4	D1480	A, B	Third-party graphics hardware	A
SLOT5 X16 GEN4	D1480	A, B	Third-party graphics hardware	A
SLOT6 X8 GEN4	MURAIPIXI-E4JHF	A, C	MURAIPIXI-E4JHF	A

Performance considerations with D-Series controller

Slot	Connectivity	Configuration 1	Configuration 2	Configuration 3	Configuration 4
SLOT1 x16 GEN4	x16	B	B	B	B
SLOT2 x8 GEN4	x8	A	A	A	A
SLOT3 x16 GEN4	x16	A	B	B	B
SLOT4 x16 GEN4	x16	A	A	A	B
SLOT5 x16 GEN4	x16	A	A	B	B
SLOT6 x8 GEN4	x8	A	A	A	A

Note: Slot 6 PCIe lanes connect through IOH. Performance may be reduced.

Option	Product
A	MURAI PXI-E4SF, MURAI PXI-E4SHF, MURAI PXI-D2MF, MURAI PXI-D2MHF, MURAI PXI-E2MF, MURAI PXI-E2MHF, MURAI PXI-D4JF, MURAI PXI-D4JHF, MURAI PXI-E4JF, or MURAI PXI-E4JHF
B	D1450 or D1480
C	Matrox M9148 LP PCIe x16, Matrox M9140 LP PCIe x16, Matrox M9138 LP PCIe x16, Matrox M9128 LP PCIe x16, Matrox M9120 Plus LP PCIe x16, Matrox M9120 Plus LP PCIe x1, Matrox M9120 PClex16, NVIDIA Quadro P620, NVIDIA Quadro P600, NVIDIA Quadro P400, NVIDIA Quadro K620, NVIDIA GeForce GT710, AMD Radeon WX2100, or AMD Radeon Vega 8 (add-in card console options)

Portwell M8030

	D-Series based controllers	Third-party based controllers
Validated	Yes	No foreseeable compatibility issues
Maximum number of cards supported	8	
Maximum supported Mura IPX Series	7	
Maximum supported D-Series	4	
Motherboard	PBPE-09A-MT (Backplane), ROBO-6911VG2AR (SHB)	
Chipset	Intel C236	
Processor	Intel® Core™ i7-6700 CPU @ 3.40 GHz, 3408 MHz, 4 Core(s)	
Heatsink (for CPU)	LGA 1151	
System BIOS version	90821T00,2019-08-21	
System memory	32 GB DDR4 SODIMM	
Chassis	4U rack-mount	
Power supply	950 W redundant power supply	
PCIe expansion slots	<ul style="list-style-type: none"> ▪ 2 PCIe x16 3.0 slots (x16 mechanical, x16 electrical) ▪ 6 PCIe x16 slots (x16 mechanical, x8 electrical) 	
Notes	<ul style="list-style-type: none"> ▪ On-board driver must be installed first prior to setting up the D-Series controller. ▪ In the system BIOS, go to Advanced → Graphics Configuration → Internal Graphics → and select Enabled. ▪ In the system BIOS, go to Advanced → Chipset Configuration → Above 4G MMIO BIOS Assignment → and select Enabled. ▪ The system BIOS is available at ftp://pw_m8030:YXCN54Ek@privftp.matrox.com. ▪ Portwell system BIOS files with “-MT” are custom BIOS versions specific to Matrox configurations. 	

Configurations

Slot	D-Series based controller		Third-party based controller	
	Main	Option	Main	Option
J1	D1480	B	Third-party graphics hardware	-
J2	D1480	A, B	Third-party graphics hardware	A
J3	D1480	A, B	Third-party graphics hardware	A
J4	D1480	A, B	Third-party graphics hardware	A
J5	MURAIPIXI-E4JF	A	MURAIPIXI-E4JF	A
J6	MURAIPIXI-E4JF	A	MURAIPIXI-E4JF	A
J7	MURAIPIXI-E4JF	A	MURAIPIXI-E4JF	A
J8	MURAIPIXI-E4JF	A	MURAIPIXI-E4JF	A

Performance considerations with D-Series controller

Slot	Connectivity	Configuration 1	Configuration 2	Configuration 3	Configuration 4
J1	x16	B	B	B	B
J2	x16	A	B	B	B
J3	x8	A	A	B	B
J4	x8	A	A	A	B
J5	x8	A	A	A	A
J6	x8	A	A	A	A
J7	x8	A	A	A	A
J8	x8	A	A	A	A

Note: The backplane has a single PCIe x16 Gen3 connection to the CPU. The maximum stream bandwidth is limited to 12 GB/s.

Option	Product
A	MURAIPXI-E4SF, MURAIPXI-E4SHF, MURAIPXI-D2MF, MURAIPXI-D2MHF, MURAIPXI-E2MF, MURAIPXI-E2MHF, MURAIPXI-D4JF, MURAIPXI-D4JHF, MURAIPXI-E4JF, or MURAIPXI-E4JHF
B	D1450 or D1480

Motherboard layout

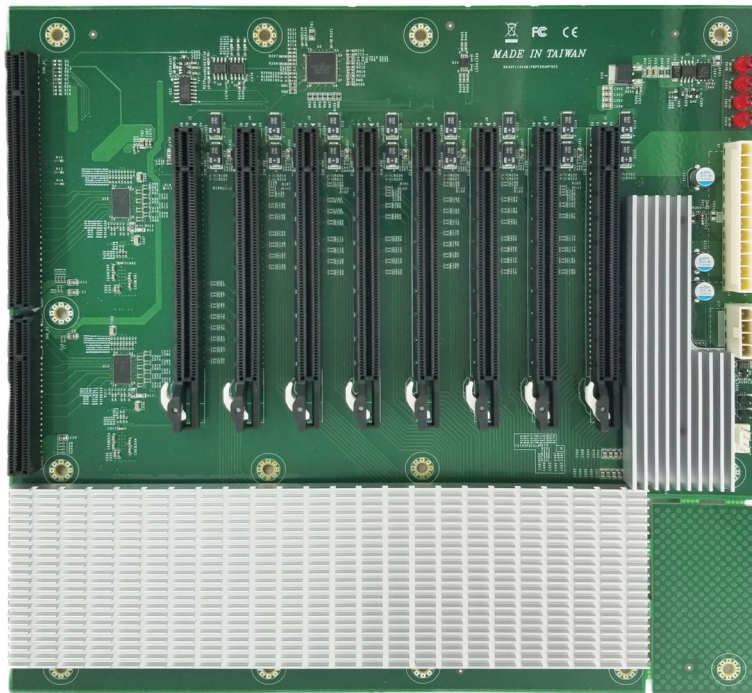

Portwell NURO-771R

	D-Series based controllers	Third-party based controllers
Validated	Yes	No foreseeable compatibility issues

Maximum number of cards supported	7
Maximum supported Mura IPX Series	6
Maximum supported D-Series	4
Validated OS	Windows 10 Enterprise LTSC; Version 10.0.19044 Build 19044
Motherboard	Asrock Rack ROMED8-2T
Chipset	SoC
Processor	AMD EPYC 7262 3.2 GHz
Heatsink (for CPU)	SP3 (LGA4094)
System BIOS version	L3.54E, 4/10/2023
System memory	128 GB (8 x16 GB 3200 MHz DDR4 RDIMM)
Chassis	4U
Power supply	800 W
PCIe expansion slots	<ul style="list-style-type: none"> 7 PCIe x16 4.0 slots
Notes	<ul style="list-style-type: none"> The chassis fan must run at full speed. <ul style="list-style-type: none"> Ambient temperature is limited to 35°C with the default 2 x 120 mm x 120 mm x 38 mm 120 CFM front chassis fans. Ambient temperature is limited to 40°C with the optional 2 x 120 mm x 120 mm x 38 mm 150 CFM front chassis fans. Ambient temperature is limited to 45°C with the optional 2 x 120 mm x 120 mm x 38 mm 193 CFM front chassis fans. In the system BIOS, go to Advanced → Chipset Configuration → Primary Graphics Adaptor → and select Onboard. In the system BIOS, go to Advanced → Chipset Configuration → Onboard VGA → and select Auto. On-board driver must be installed before setting up the D-Series controller. Ensure to have the following default settings for Above 4G Decoding in the system BIOS: <ul style="list-style-type: none"> Go to Advanced → PCI Subsystem Settings → Above 4G Decoding → select Enabled. On-board console support with D-Series controller. Requires 3.05 or later drivers. PCIe2 Gen4 x16 link shared with M2_1/OCU1/OCU2/SATA_4_7 by two 3-pin PE8_SEL/PE16_SEL jumpers. For PCIe2 slot to run at x16 mode, set M2_1/SATA_4_7/OCU1/OCU2 to Disabled.

Configurations

Slot	D-Series based controller		Third-party based controller	
	Main	Option	Main	Option
PCIE1	D1480	A, B	Third-party graphics hardware	-
PCIE2	MURAI PXI-E4JHF	A	MURAI PXI-E4JHF	A
PCIE3	D1480	A, B	Third-party graphics hardware	A
PCIE4	MURAI PXI-E4JHF	A, B	MURAI PXI-E4JHF	A
PCIE5	D1480	A, B	Third-party graphics hardware	A
PCIE6	MURAI PXI-E4JF	A	MURAI PXI-E4JHF	A
PCIE7	D1480	B	Third-party graphics hardware	A

Performance considerations with D-Series controller

Slot	Connectivity	Configuration 1	Configuration 2	Configuration 3	Configuration 4
PCIE1	x16	A	A	A	B
PCIE2*	x16 / x8	A	A	A	A
PCIE3	x16	A	A	B	B
PCIE4	x16	A	B	A	A
PCIE5	x16	A	A	B	B
PCIE6	x16	A	A	A	A
PCIE7	x16	B	B	B	B

Note: * PCIE2 Gen4 x16 link shared with M2_1/OCU1/OCU2/SATA_4_7 by PE8_SEL/PE16_SEL jumpers. For slot PCI2 to run x16 mode, set M2_1/SATA_4_7/OCU1/OCU2 to Disabled.

Option	Product
A	MURAI PXI-E4SF, MURAI PXI-E4SHF, MURAI PXI-D2MF, MURAI PXI-D2MHF, MURAI PXI-E2MF, MURAI PXI-E2MHF, MURAI PXI-D4JF, MURAI PXI-D4JHF, MURAI PXI-E4JF, or MURAI PXI-E4JHF
B	D1450 or D1480

Supermicro SYS-420GP-TNR

	D-Series based controllers	Third-party based controllers
Validated	Yes	No foreseeable compatibility issues
Maximum number of cards supported	12	
Maximum supported Mura IPX Series	11	
Maximum supported D-Series	4	
Validated OS	Windows 10 Enterprise 21H1 LTSC 2021; Version 10.0.19044 Build 19044	
Motherboard	Supermicro Super X12DPG-OA6	
Chipset	Intel C621A	
Processor	Intel® Xeon® Silver 4310 Dual CPU @ 2.10 GHz	
Heatsink (for CPU)	LGA-4189 Dual Socket	
System BIOS version	American Megatrends International, LLC. 1.4, 2022-08-23	
System memory	64 GB (16 x4 GB 2666 MHz DDR4 ECC RDIMM)	
Chassis	CSE-418G2TS-R4016BP	
Power supply	2000 W Redundant PSU	
PCIe expansion slots	<ul style="list-style-type: none"> 12 PCIe 4.0 x16 slots 	
Notes	<ul style="list-style-type: none"> The system fan speed is at default standard speed. Ensure to have the following settings for Above 4G Decoding in the system BIOS: <ul style="list-style-type: none"> Go to Advanced → PCIe/PCI/PnP Configuration → Above 4G Decoding → select Enabled. There are thirty-two DIMM slots. Ensure to have at least one DIMM populated per memory channel for optimized performance. Follow the memory population sequence as outlined in the system manual. 	

Configurations

Slot	D-Series based controller		Third-party based controller	
	Main	Option	Main	Option
SLOT 1 CPU1 (x16) - PLX	MURAI PXI-E4JHF	A	MURAI PXI-E4JHF	A
SLOT 2 CPU1 (x16) - PLX	MURAI PXI-E4JHF	A	MURAI PXI-E4JHF	A
SLOT 3 CPU1 (x16) - PLX	MURAI PXI-E4JHF	A, B	Third-party graphics hardware	A
SLOT 4 CPU1 (x16) - PLX	MURAI PXI-E4JHF	A	MURAI PXI-E4JHF	A
SLOT 5 CPU1 (x16) - PLX	MURAI PXI-E4JHF	A	MURAI PXI-E4JHF	A
SLOT 6 CPU1 (x16) - DIRECT	D1480	B	Third-party graphics hardware	-
SLOT 7 CPU2 (x16) - PLX	MURAI PXI-E4JHF	A	MURAI PXI-E4JHF	A
SLOT 8 CPU2 (x16) - PLX	MURAI PXI-E4JHF	A	MURAI PXI-E4JHF	A
SLOT 9 CPU2 (x16) - PLX	MURAI PXI-E4JHF	A, B	Third-party graphics hardware	A
SLOT 10 CPU2 (x16) - PLX	MURAI PXI-E4JHF	A	MURAI PXI-E4JHF	A
SLOT 11 CPU2 (x16) - PLX	MURAI PXI-E4JHF	A	MURAI PXI-E4JHF	A
SLOT 12 CPU2 (x16) - DIRECT	D1480	A, B	Third-party graphics hardware	A

Performance considerations with D-Series controller

Slot	Connectivity	Configuration 1	Configuration 2	Configuration 3	Configuration 4
SLOT 1 CPU1 (x16) - PLX	x16	A	A	A	A
SLOT 2 CPU1 (x16) - PLX	x16	A	A	A	A
SLOT 3 CPU1 (x16) - PLX	x16	A	A	B	B
SLOT 4 CPU1 (x16) - PLX	x16	A	A	A	A
SLOT 5 CPU1 (x16) - PLX	x16	A	A	A	A
SLOT 6 CPU1 (x16) - DIRECT	x16	B	B	B	B
SLOT 7 CPU2 (x16) - PLX	x16	A	A	A	A
SLOT 8 CPU2 (x16) - PLX	x16	A	A	A	A
SLOT 9 CPU2 (x16) - PLX	x16	A	A	A	B
SLOT 10 CPU2 (x16) - PLX	x16	A	A	A	A
SLOT 11 CPU2 (x16) - PLX	x16	A	A	A	A
SLOT 12 CPU2 (x16) - DIRECT	x16	A	B	B	B

Option	Product
A	MURAI PXI-E4SF, MURAI PXI-E4SHF, MURAI PXI-D2MF, MURAI PXI-D2MHF, MURAI PXI-E2MF, MURAI PXI-E2MHF, MURAI PXI-D4JF, MURAI PXI-D4JHF, MURAI PXI-E4JF, or MURAI PXI-E4JHF
B	D1450 or D1480

Supermicro SYS-5049A-TR

	D-Series based controllers	Third-party based controllers
Validated	Yes	No foreseeable compatibility issues

Maximum number of cards supported	7
Maximum supported Mura IPX Series	6
Maximum supported D-Series	4
Motherboard	X11SPA-TF/X11SPA-T
Chipset	Intel C621
Processor	Intel® Xeon® Silver 4208 CPU @ 2.10 GHz
Heatsink (for CPU)	LGA 3647
System BIOS version	3.8a, 2022-10-28
System memory	32 GB DDR4 ECC-RDIMM
Chassis	4U
Power supply	2200 W redundant power supply
PCIe expansion slots	<ul style="list-style-type: none"> 4 PCIe x16 3.0 slots (x16 electrical and mechanical) 3 PCIe x16 3.0 slots (x8 electrical, x16 mechanical)
Notes	<ul style="list-style-type: none"> The system fan speed must be set to HeavyIO mode in IPMI. Optional rack-mount kit mounting rails are available (Supermicro part#: MCP-290-00059-0B).

Configurations

Slot	D-Series based controller		Third-party based controller	
	Main	Option	Main	Option
CPUSLOT1PCI-E3.0x16	D1480	B	Third-party graphics hardware	-
CPUSLOT2PCI-E3.0x8	MURAI PXI-D4JF	A	MURAI PXI-D4JF	A
CPUSLOT3PCI-E3.0x16	D1480	A, B	Third-party graphics hardware	A
CPUSLOT4PCI-E3.0x8	MURAI PXI-D4JF	A	MURAI PXI-D4JF	A
CPUSLOT5PCI-E3.0x16	D1480	A, B	Third-party graphics hardware	A
CPUSLOT6PCI-E3.0x8	MURAI PXI-D4JF	A	MURAI PXI-D4JF	A
CPUSLOT7PCI-E3.0x16	D1480	A, B	Third-party graphics hardware	A

Performance considerations with D-Series controller

Slot	Connectivity	Configuration 1	Configuration 2	Configuration 3	Configuration 4
CPUSLOT1PCI-E3.0x16	x16	B	B	B	B
CPUSLOT2PCI-E3.0x8	x8 / x0	A	A	A	A
CPUSLOT3PCI-E3.0x16	x16 / x8	A	B*	B*	B*
CPUSLOT4PCI-E3.0x8	x8 / x0	A	A	A	A
CPUSLOT5PCI-E3.0x16	x16 / x8	A	A	B*	B*
CPUSLOT6PCI-E3.0x8	x8 / x0	A	A	A	A
CPUSLOT7PCI-E3.0x16	x16 / x8	A	A	A	B*

Note: * The D-Series bandwidth is reduced to 6 GB/s instead of 12 GB/s when shared slots are used. However, the performance depends on the layout, the number of streams going to each D-Series, rendering done, and the intended usage. Shared slots are 2&3, 4&5, and 6&7.

Option	Product
A	MURAI PXI-E4SF, MURAI PXI-E4SHF, MURAI PXI-D2MF, MURAI PXI-D2MHF, MURAI PXI-E2MF, MURAI PXI-E2MHF, MURAI PXI-D4JF, MURAI PXI-D4JHF, MURAI PXI-E4JF, or MURAI PXI-E4JHF
B	D1450 or D1480

Motherboard layout

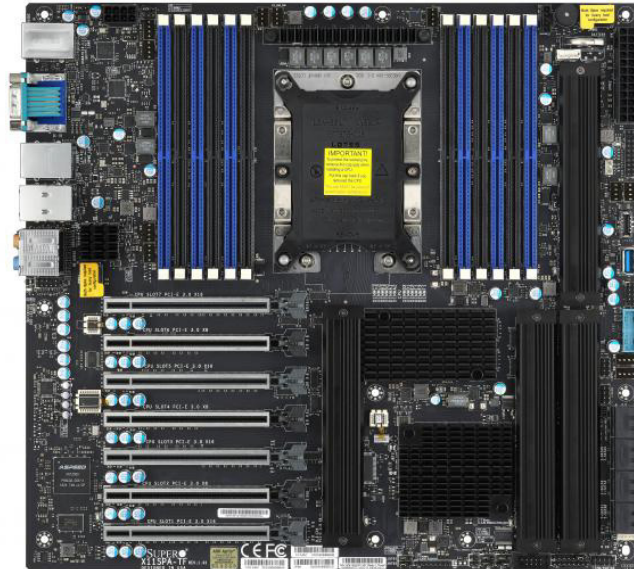

Supermicro SYS-540A-TR

	D-Series based controllers	Third-party based controllers
Validated	Yes	No foreseeable compatibility issues

Maximum number of cards supported	7
Maximum supported Mura IPX Series	6
Maximum supported D-Series	4
Validated OS	Windows 10 Enterprise LTSC; Version 10.0.19044 Build 19044
Motherboard	X12SPA-TF
Chipset	Intel C621A
Processor	Intel® Xeon® W-3335 CPU @ 3.4 GHz
Heatsink (for CPU)	LGA-4189
System BIOS version	1.1, 2021-06-21
System memory	64 GB (8 x 8 GB 3200 MHz DDR4 ECC-RDIMM)
Chassis	CSE-747BTS-R2K20BP
Power supply	2200 W redundant power supply
PCIe expansion slots	<ul style="list-style-type: none"> ▪ 4 PCIe x16 4.0 slots ▪ 3 PCIe x8 4.0 slots (in x16 slots)
Notes	<ul style="list-style-type: none"> ▪ The system fan speed must be set to run at full speed in IPMI. ▪ Ensure to have the following settings for Onboard VGA in the system BIOS: <ul style="list-style-type: none"> ▪ Go to Advanced → PCIe/PCI/PnP Configuration → VGA Priority → select Onboard. ▪ Onboard console support with D-Series controller. Requires 3.05 or later drivers. ▪ Ensure to have the following settings for Above 4G Decoding in the system BIOS: <ul style="list-style-type: none"> ▪ Go to Advanced → PCIe/PCI/PnP Configuration → Above 4G Decoding → select Enabled. ▪ Slot1 is shared with four M.2 slots. For Slot1 to perform at x16 electrical, disable the four M.2 slots. In the BIOS: <ul style="list-style-type: none"> ▪ Go to Advanced → PCIe/PCI/PnP Configuration → M.2-C01 PCI-e 4.0 x4 OPROM → select Disabled. ▪ Go to Advanced → PCIe/PCI/PnP Configuration → M.2-C02 PCI-e 4.0 x4 OPROM → select Disabled. ▪ Go to Advanced → PCIe/PCI/PnP Configuration → M.2-C03 PCI-e 4.0 x4 OPROM → select Disabled. ▪ Go to Advanced → PCIe/PCI/PnP Configuration → M.2-C04 PCI-e 4.0 x4 OPROM → select Disabled. ▪ There are sixteen DIMM slots. Ensure to have at least one DIMM populated per memory channel for optimized performance. Follow the memory population sequence as outlined in the system manual. ▪ Optional rack-mount kit mounting rails are available (Supermicro part#: MCP-290-00059-0B).

Configurations

Slot	D-Series based controller		Third-party based controller	
	Main	Option	Main	Option
CPUSLOT1PCI-E4.0x16	D1480	B	Third-party graphics hardware	-
CPUSLOT2PCI-E4.0x8(INx16)	MURAIPIXI-E4JHF	A	MURAIPIXI-E4JHF	A
CPUSLOT3PCI-E4.0x16	D1480	A, B	Third-party graphics hardware	A
CPUSLOT4PCI-E4.0x8(INx16)	MURAIPIXI-E4JHF	A	MURAIPIXI-E4JHF	A
CPUSLOT5PCI-E4.0x16	D1480	A, B	Third-party graphics hardware	A
CPUSLOT6PCI-E4.0x8(INx16)	MURAIPIXI-E4JHF	A	MURAIPIXI-E4JHF	A
CPUSLOT7PCI-E4.0x16	D1480	A, B	Third-party graphics hardware	A

Performance considerations with D-Series controller

Slot	Connectivity	Configuration 1	Configuration 2	Configuration 3	Configuration 4
CPUSLOT1PCI-E4.0x16	x16 / x8*	B	B	B	B
CPUSLOT2PCI-E4.0x8(INx16)	x8 / x0	A	A	A	A
CPUSLOT3PCI-E4.0x16	x16 / x8	A	B	B	B
CPUSLOT4PCI-E4.0x8(INx16)	x8 / x0	A	A	A	A
CPUSLOT5PCI-E4.0x16	x16 / x8	A	A	B	B
CPUSLOT6PCI-E4.0x8(INx16)	x8 / x0	A	A	A	A
CPUSLOT7PCI-E4.0x16	x16 / x8	A	A	A	B

Note: Shared slots are 2&3, 4&5, and 6&7.

* Slot1 is shared with M.2 slots. For Slot1 to perform at x16 electrical, disable the four M.2 slots in the system BIOS.

Option	Product
A	MURAI PXI-E4SF, MURAI PXI-E4SHF, MURAI PXI-D2MF, MURAI PXI-D2MHF, MURAI PXI-E2MF, MURAI PXI-E2MHF, MURAI PXI-D4JF, MURAI PXI-D4JHF, MURAI PXI-E4JF, or MURAI PXI-E4JHF
B	D1450 or D1480

Motherboard layout

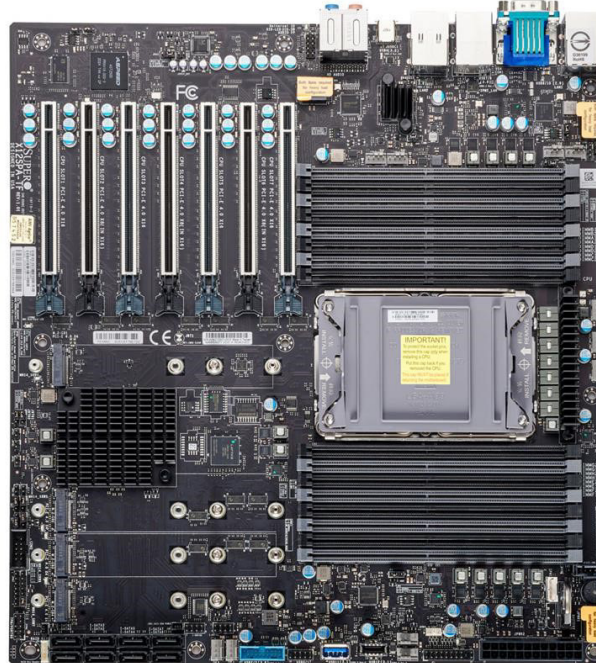

Supermicro SYS-551A-T

	D-Series based controllers	Third-party based controllers
Validated	Yes	No foreseeable compatibility issues

Maximum number of cards supported	6
Maximum supported Mura IPX Series	5
Maximum supported D-Series	4
Validated OS	Windows 10 Enterprise LTSC; Version 10.0.19044 Build 19044
Motherboard	Supermicro X13SWA-TF
Chipset	Intel® W790
Processor	Intel® Xeon® W5-3423 CPU @ 2.1 GHz
Heatsink (for CPU)	LGA 4677 (Part# SNK-P0091AP4)
System BIOS version	1.1, 2023-02-15
System memory	128 GB (8 x16 GB 4800 MHz ECC DDR5 RDIMM)
Chassis	Supermicro CSE-GS7A-2000B (with aircooled configuration)
Power supply	2000 W
PCIe expansion slots	6 PCIe x16 5.0 slots
Notes	<ul style="list-style-type: none"> Ensure to order the aircooled configuration for the chassis. When ordering the system, one 120 mm x 120 mm x 25 mm 6.4 KRPM optional fan (Part#: FAN-0222L4) must be ordered separately for the rear fan for aircooled configuration. Two 120 mm x 120 mm x 25 mm 59 CFM front fans that come with the system by default must be replaced with two 120 mm x 120 mm x 25 mm 113 CFM fans. The chassis fans speed must be set to Heavy I/O in IPMI. In the system BIOS go to Advanced → PCIe/PCI/PnP Configuration → VGA Priority → select Offboard. Ensure to have the following default settings for Above 4G Decoding in the system BIOS: Go to Advanced → PCIe/PCI/PnP Configuration → Above 4G Decoding → select Enabled. On-board console support with D-series controller. Require 3.05 or later drivers. Optional rack-mount kit mounting rails are available (Supermicro Part#: MCP-290-00057-0N).

Configurations

Slot	D-Series based controller		Third-party based controller	
	Main	Option	Main	Option
CPUSLOT1PCIe5.0X16	D1480	A, B	Third-party graphics hardware	A
SLOT2 (no connector)	-	-	-	-
CPUSLOT3PCIe5.0X16	D1480	A, B	Third-party graphics hardware	A
CPUSLOT4PCIe5.0X16	MURAIPIXI-E4JHF	A	MURAIPIXI-E4JHF	A
CPUSLOT5PCIe5.0X16	D1480	A, B	Third-party graphics hardware	A
CPUSLOT6PCIe5.0X16	MURAIPIXI-E4JHF	A	MURAIPIXI-E4JHF	A
CPUSLOT7PCIe5.0X16	D1480	B	Third-party graphics hardware	-

Performance considerations with D-Series controller

Slot	Connectivity	Configuration 1	Configuration 2	Configuration 3	Configuration 4
CPUSLOT1PCIe5.0X16	x16	A	A	A	B
SLOT2	No connector	-	-	-	-
CPUSLOT3PCIe5.0X16	x16	A	A	B	B
CPUSLOT4PCIe5.0X16	x16	A	A	A	A
CPUSLOT5PCIe5.0X16	x16	A	B	B	B
CPUSLOT6PCIe5.0X16	x16	A	A	A	A
CPUSLOT7PCIe5.0X16	x16	B	B	B	B

Option	Product
A	MURAIPIXI-E4SF, MURAIPIXI-E4SHF, MURAIPIXI-D2MF, MURAIPIXI-D2MHF, MURAIPIXI-E2MF, MURAIPIXI-E2MHF, MURAIPIXI-D4JF, MURAIPIXI-D4JHF, MURAIPIXI-E4JF, or MURAIPIXI-E4JHF
B	D1450 or D1480

Motherboard layout

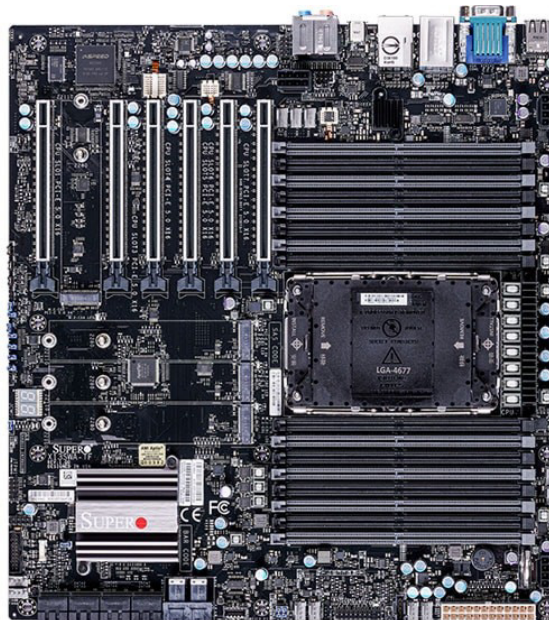

Supermicro SYS-6049GP-TRT

	D-Series based controllers	Third-party based controllers
Validated	Yes	No foreseeable compatibility issues
Maximum number of cards supported	20	
Maximum supported Mura IPX Series	16	
Maximum supported D-Series	4	
Motherboard	X11DPG-OT-CPU	
Chipset	Intel® C622	
Processor	Intel® Xeon® Silver 4208 dual CPU @ 2.10 GHz	
Heatsink (for CPU)	LGA 3647	
System BIOS version	3.4, 2020-12-18	
System memory	96 GB DDR4 ECC-RDIMM	
Chassis	4U (CSE-848GTS-R4000P)	
Power supply	2200 W redundant power supply	
PCIe expansion slots	<ul style="list-style-type: none"> 20 PCIe x16 3.0 slots (x16 electrical and mechanical) 1 PCIe x16 3.0 slot (x8 electrical, x16 mechanical) 	
Notes	<ul style="list-style-type: none"> On-board console support with D-Series controller. Requires 3.05 or later drivers. There are six memory channels per CPU. Each memory channel has two DIMM slots. Ensure each memory channel has at least one DIMM slot populated for optimized performance. Follow the dual CPU memory population sequence as outlined in the system manual. SLOT11CPU1PCIE3.0x8 comes populated with RAID add-in-card and is unavailable for display wall configurations. 	

Configurations

Slot	D-Series based controller		Third-party based controller	
	Main	Option	Main	Option
SLOT1CPU2PCIE3.0x16	D1480	A, B	Third-party graphics hardware	A
SLOT2CPU2PCIE3.0x16	MURAI PXI-D4JHF	A	MURAI PXI-D4JHF	A
SLOT3CPU2PCIE3.0x16	MURAI PXI-D4JHF	A	MURAI PXI-D4JHF	A
SLOT4CPU2PCIE3.0x16	MURAI PXI-D4JHF	A	MURAI PXI-D4JHF	A
SLOT5CPU2PCIE3.0x16	MURAI PXI-D4JHF	A	MURAI PXI-D4JHF	A
SLOT6CPU2PCIE3.0x16	D1480	A, B	Third-party graphics hardware	A
SLOT7CPU2PCIE3.0x16	MURAI PXI-D4JHF	A	MURAI PXI-D4JHF	A
SLOT8CPU2PCIE3.0x16	MURAI PXI-D4JHF	A	MURAI PXI-D4JHF	A
SLOT9CPU2PCIE3.0x16	MURAI PXI-D4JHF	A	MURAI PXI-D4JHF	A
SLOT10CPU2PCIE3.0x16	MURAI PXI-D4JHF	A	MURAI PXI-D4JHF	A
SLOT11CPU1PCIE3.0x8 (in x16)	Unavailable	-	Unavailable	-
SLOT12CPU1PCIE3.0x16	D1480	B	Third-party graphics hardware	-
SLOT13CPU1PCIE3.0x16	MURAI PXI-D4JHF	A	MURAI PXI-D4JHF	A
SLOT14CPU1PCIE3.0x16	MURAI PXI-D4JHF	A	MURAI PXI-D4JHF	A
SLOT15CPU1PCIE3.0x16	MURAI PXI-D4JHF	A	MURAI PXI-D4JHF	A
SLOT16CPU1PCIE3.0x16	MURAI PXI-D4JHF	A	MURAI PXI-D4JHF	A
SLOT17CPU1PCIE3.0x16	D1480	A, B	Third-party graphics hardware	A

Slot	D-Series based controller		Third-party based controller	
	Main	Option	Main	Option
SLOT18CPU1PCIE3.0x16	MURAI PXI-D4JHF	A	MURAI PXI-D4JHF	A
SLOT18CPU1PCIE3.0x16	MURAI PXI-D4JHF	A	MURAI PXI-D4JHF	A
SLOT20CPU1PCIE3.0x16	MURAI PXI-D4JHF	A	MURAI PXI-D4JHF	A
SLOT21CPU1PCIE3.0x16	MURAI PXI-D4JHF	A	MURAI PXI-D4JHF	A

Performance considerations with D-Series controller

Slot	Connectivity	Configuration
SLOT1CPU2PCIE3.0x16	x16	B
SLOT2CPU2PCIE3.0x16	x16	A
SLOT3CPU2PCIE3.0x16	x16	A
SLOT4CPU2PCIE3.0x16	x16	A
SLOT5CPU2PCIE3.0x16	x16	A
SLOT6CPU2PCIE3.0x16	x16	B
SLOT7CPU2PCIE3.0x16	x16	A
SLOT8CPU2PCIE3.0x16	x16	A
SLOT9CPU2PCIE3.0x16	x16	A
SLOT10CPU2PCIE3.0x16	x16	A
SLOT11CPU1PCIE3.0x8 (in x16)*	x8	N/A
SLOT12CPU1PCIE3.0x16	x16	B
SLOT13CPU1PCIE3.0x16	x16	A
SLOT14CPU1PCIE3.0x16	x16	A
SLOT15CPU1PCIE3.0x16	x16	A
SLOT16CPU1PCIE3.0x16	x16	A
SLOT17CPU1PCIE3.0x16	x16	B
SLOT18CPU1PCIE3.0x16	x16	A
SLOT19CPU1PCIE3.0x16	x16	A
SLOT20CPU1PCIE3.0x16	x16	A
SLOT21CPU1PCIE3.0x16	x16	A

Note: * Comes populated with RAID add-in-card and is unavailable for display wall configurations.

Option	Product
A	MURAI PXI-E4SF, MURAI PXI-E4SHF, MURAI PXI-D2MF, MURAI PXI-D2MHF, MURAI PXI-E2MF, MURAI PXI-E2MHF, MURAI PXI-D4JF, MURAI PXI-D4JHF, MURAI PXI-E4JF, or MURAI PXI-E4JHF
B	D1450 or D1480

EOL (End of Life) systems

Portwell M9030 (with ROBO-8113VG2AR SHB)

	D-Series based controllers	Third-party based controllers
Validated	Yes	No foreseeable compatibility issues
Maximum number of cards supported	10	
Maximum supported Mura IPX Series	9	
Maximum supported D-Series	4	
Motherboard	Portwell PBPE-11A-MT (Backplane) Portwell ROBO-8113VG2AR (SHB)	
Chipset	Intel C246	
Processor	Intel® Core™ i3-6100E CPU @ 3.70 GHz, 3700 MHz	
Heatsink (for CPU)	LGA 1151	
System BIOS version	R1.00.E0, 2019-12-16	
System memory	32 GB DDR4	
Chassis	4U rack-mount	
Power supply	950 W redundant power supply	
PCIe expansion slots	<ul style="list-style-type: none"> 10 PCIe x16 2.0 slots (x16 mechanical, x16 electrical) 	
Notes	<ul style="list-style-type: none"> In the system BIOS, go to Advanced → Graphics Configuration → Internal Graphics → and select Disabled. In the system BIOS, go to Advanced → Chipset Configuration → Above 4G MMIO BIOS Assignment → and select Enabled. In the system BIOS, go to Advanced → Chipset Configuration → Above 4G Decoding → and select Enabled. The system BIOS is available at ftp://portwell_bios:xQGnkWnQ@privftp.matrox.com. Portwell system BIOS files with “-MT” are custom BIOS versions specific to Matrox configurations. 	

Configurations

Slot	D-Series based controller		Third-party based controller	
	Main	Option	Main	Option
J1	D1480	B	Third-party graphics hardware	-
J2	MURAIPIXI-E4JHF	A	MURAIPIXI-E4JHF	A
J3	D1480	A, B	Third-party graphics hardware	A
J4	MURAIPIXI-E4JHF	A	MURAIPIXI-E4JHF	A
J5	MURAIPIXI-E4JHF	A	MURAIPIXI-E4JHF	A
J6	D1480	A, B	Third-party graphics hardware	A
J7	MURAIPIXI-E4JHF	A	MURAIPIXI-E4JHF	A
J8	D1480	A, B	Third-party graphics hardware	A
J9	MURAIPIXI-E4JHF	A	MURAIPIXI-E4JHF	A
J10	MURAIPIXI-E4JHF	A	MURAIPIXI-E4JHF	A

Performance considerations with D-Series controller

Slot	Connectivity	Configuration 1	Configuration 2	Configuration 3	Configuration 4
J1	x16	B	B	B	B
J2	x16	A	A	A	A
J3	x16	A	A	B	B
J4	x16	A	A	A	A
J5	x16	A	A	A	A
J6	x16	A	B	B	B
J7	x16	A	A	A	A
J8	x16	A	A	A	B
J9	x16	A	A	A	A
J10	x16	A	A	A	A

Note: The backplane has a single PCIe x16 Gen2 connection to the CPU. Therefore, the maximum stream bandwidth is limited to 6 GB/s in the best case scenario.

Option	Product
A	MURAIPIXI-E4SF, MURAIPIXI-E4SHF, MURAIPIXI-D2MF, MURAIPIXI-D2MHF, MURAIPIXI-E2MF, MURAIPIXI-E2MHF, MURAIPIXI-D4JF, MURAIPIXI-D4JHF, MURAIPIXI-E4JF, or MURAIPIXI-E4JHF
B	D1450 or D1480

Motherboard layout

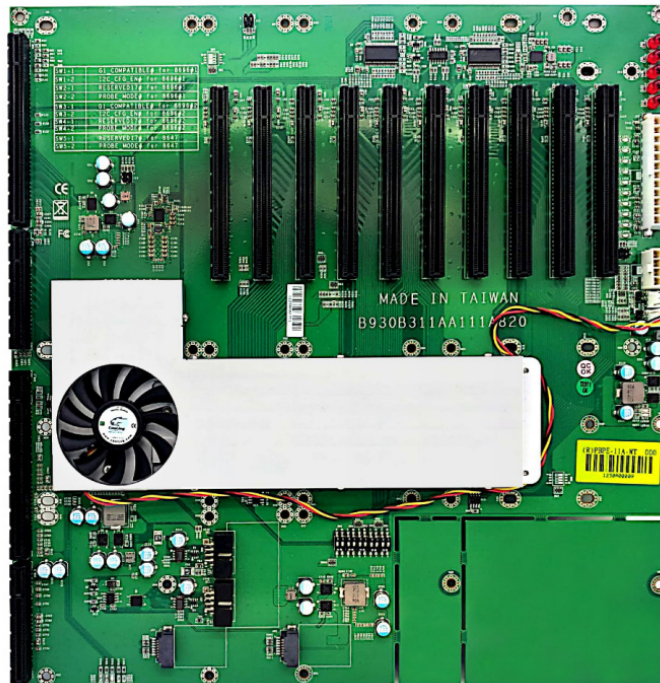

Validated motherboards

The following motherboards have been validated by Matrox to work with Matrox Mura IPX Series, Matrox D1450, and Matrox D1480 products.

- Note:** For improved performance, we recommend you avoid using PCIe® x4 slots or lower.
- Note:** Ensure to have the following default settings to launch the Windows 10 operating system:
 - In the system BIOS main page, go to **Boot Tab** → **Boot Mode Select** → and select **UEFI**.
 - In the system BIOS main page, go to **Boot Tab** → **CSM** → **Launch CSM** and select **Disabled**.
- Note:** The motherboard must be populated with at least 32 GB of system memory. In addition, ensure to have all the memory channels populated. For example, if your system or motherboard has four memory channels, make sure to populate all the channels to add up to 32 GB (8 GB per channel totaling to 32 GB).
 - If there are two DIMM slots per memory channel, you must populate at least one DIMM slot for each channel for optimal memory bandwidth. Follow the motherboard manufacturer’s guideline for memory population sequence.
 - We recommend choosing memory from the motherboard manufacturer’s supported list. The actual memory frequency may differ depending on the CPU types and the memory module used.

Currently supported motherboards

The following validated motherboards are currently supported.

Validated motherboard	Maximum number of boards supported per system
Advantech ASMB-815	5
Advantech PCE-5B12 with PCE-7131 / PCE-7129 SHB	10
Advantech PCE-5B19 with PCE-7131 / PCE-7129	15
Asrock C621A WS	7
Asrock Rack ROMED8-2T	7
ASUS Pro WS W790E-SAGE SE	7
ASUS Pro WS WRX80E-SAGE SE WIFI	7
ASUS Pro WS X299 SAGE II	7
ASUS WS C422 PRO/SE	4
ASUS WS C422 SAGE 10G	7
ASUS WS C621E SAGE	7
Gigabyte C246-WU4	4
Gigabyte MU72-SU0	7
Gigabyte WRX80-SU8-IPMI (rev 1.0)	7
MSI TRX40 PRO 10G	4
Portwell M9010A (with ROBO-8113VG2AR SHB)	10
Supermicro C9Z390-PGW	4
Supermicro C9Z490-PG	4
Supermicro H11SSL-i	4

Validated motherboard	Maximum number of boards supported per system
Supermicro X11SPA-TF/X11SPA-T	7
Supermicro X12SPA-TF	7
Supermicro X13SWA-TF	6

Advantech ASMB-815

	D-Series based controllers	Third-party based controllers
Validated	Yes	No foreseeable compatibility issues
Maximum number of cards supported	5	
Maximum supported Mura IPX Series	4	
Maximum supported D-Series	4	
Motherboard	Advantech ASMB-815 Part#: ASMB-815-00A1E / ASMB-815I-00A1E / ASMB-815T2-00A1E	
Chipset	Intel C621 / C622	
Processor	Intel® Xeon® Silver 4112R CPU @ 2.60 GHz Intel® Xeon® Silver 4210R CPU @ 2.40 GHz	
Heatsink (for CPU)	LGA 3647	
System BIOS version	5.14, 2020-04-23	
System memory	32 GB DDR4 ECC-RDIMM	
Chassis	ACP-4000 / ACP-4010	
Power supply	ACP-4000 chassis: Advantech FSP700-80PSA; Part#: 96PS-A700WPS2 ACP-4010 chassis: 750 W redundant power supply (Advantech part#: RPS8-750ATX-XE)	
PCIe expansion slots	<ul style="list-style-type: none"> ▪ 2 PCIe x16 3.0 slots (x16 mechanical, x16 / x8 electrical) ▪ 3 PCIe x8 3.0 slots (x8 mechanical, x8 electrical) ▪ 1 PCIe x4 3.0 slot (x4 mechanical, x4 electrical) 	
Notes	<ul style="list-style-type: none"> ▪ Requires two 120 mm x 120 mm x 25 mm 120 CFM or 150 CFM chassis fans. ▪ The dust protection sponge filter in front of the chassis must be removed for proper system ventilation. ▪ The chassis fans must run at full speed. ▪ With 120 CFM fans: <ul style="list-style-type: none"> ▪ D1400 controller: The ambient temperature must not exceed 40 degrees centigrade. ▪ With 150 CFM fans: <ul style="list-style-type: none"> ▪ Wired mesh filter can be used in front of the chassis with 150 CFM fans only. ▪ Filter requires a 18 x 18 size 304 stainless steel wire mesh. ▪ In the system BIOS, select Socket Configuration → IIO Configuration, change the following from [Auto] to [x8x8] only if the shared slots are fully populated: <ul style="list-style-type: none"> ▪ IOU1 (IIO PCIe Br2) [x8x8] ▪ IOU2 (IIO PCIe Br3) [x8x8] ▪ In the system BIOS, select Advanced → PCI Subsystem Settings, and make sure Above 4G Decoding is enabled. ▪ On-board console support with D-Series controller. Requires 3.05 or later drivers. ▪ Ensure to have the following settings for the GPU. In the system BIOS, go to Platform Configuration → PCH Devices: <ul style="list-style-type: none"> ▪ VGA Priority - Select Auto ▪ Onboard VGA Controller - Select Enable 	

Configurations

Slot	D-Series based controller		Third-party based controller	
	Main	Options	Main	Options
PCIEX1_Slot1	N/A		N/A	
PCIEX4_Slot2	N/A		N/A	
PCIEX8_Slot3	MURAI PXI-E4JF	A	MURAI PXI-E4JF	A
PCIEX16_Slot4	D1480	B	Third-party graphics hardware	-
PCIEX8_Slot5	MURAI PXI-E4JF	A, B	MURAI PXI-E4JF	A
PCIEX16_Slot6	D1480	B	Third-party graphics hardware	A
PCIEX8_Slot7	MURAI PXI-E4JF	A, B	MURAI PXI-E4JF	A

Performance considerations with D-Series controller

Slot	Connectivity	Configuration 1	Configuration 2
PCIEX1_Slot1	x1	N/A	N/A
PCIEX4_Slot2	x4	N/A	N/A
PCIEX8_Slot3	x8 / x0	A	A
PCIEX16_Slot4	x16 / x8	B*	B*
PCIEX8_Slot5	x8 / x0	A	A
PCIEX16_Slot6	x16 / x8	A	B*
PCIEX8_Slot7	x8	A	A

Note: * The GPU bandwidth is reduced to 6 GB/s instead of 12 GB/s when shared slots are used. Shared slots are 3 & 4 and 5 & 6.

Option	Product
A	MURAI PXI-E4SF, MURAI PXI-E4SHF, MURAI PXI-D2MF, MURAI PXI-D2MHF, MURAI PXI-E2MF, MURAI PXI-E2MHF, MURAI PXI-D4JF, MURAI PXI-D4JHF, MURAI PXI-E4JF, or MURAI PXI-E4JHF
B	D1450 or D1480

Motherboard layout

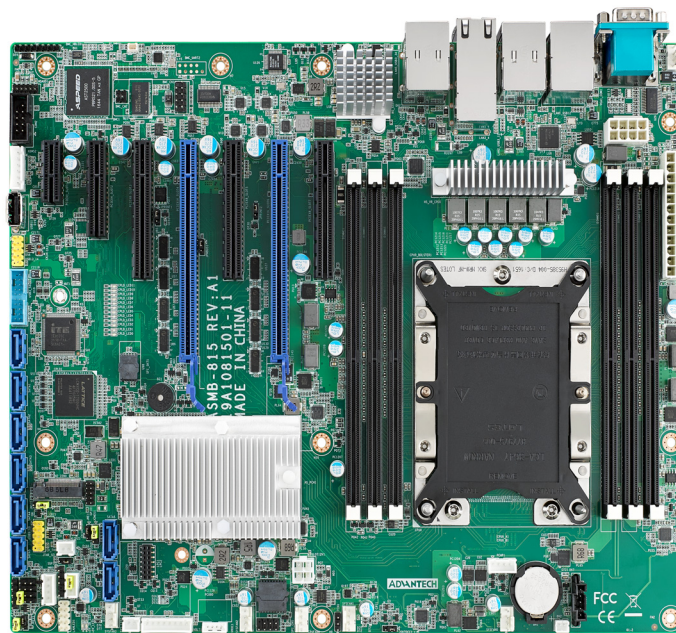

Advantech PCE-5B12 with PCE-7131 / PCE-7129 SHB

	D-Series based controllers	Third-party based controllers
Validated	Yes	No foreseeable compatibility issues
Maximum number of cards supported	10	
Maximum supported Mura IPX Series	9	
Maximum supported D-Series	4	
Motherboard	Advantech PCE-7131 / PCE-7129 (SHB) Advantech PCE-5B12-00A1 (Backplane)	
Chipset	Intel C246 (PCE-7131 SHB) Intel C236 (PCE-7129 SHB)	
Processor	Advantech PCE-7131 <ul style="list-style-type: none"> Intel® Xeon® E-2278GE CPU @ 3.30 GHz, or Intel® Core™ i7-9700E CPU @ 2.60 GHz Advantech PCE-7129 <ul style="list-style-type: none"> Intel® Core™ i7-6770S, 3.40 GHz 	
Heatsink (for CPU)	2U CPU cooler	
System BIOS version	5.13, 2020-04-09 (PCE-7131) 5.12, 2018-03-13 (PCE-7129)	
System memory	32 GB DDR4 ECC Memory (Intel Xeon E-2278GE) 32 GB DDR4 non-ECC memory (Intel i7-9700E/i7-6770S)	
Chassis	Advantech IPC-623 4U rack mount <ul style="list-style-type: none"> Chassis part#: IPC-623BP-1KZC (for single power supply; includes chassis, fans, and 1200 W power supply) Or Rackmaster 20 slot chassis <ul style="list-style-type: none"> Chassis part#: 010-0163 (includes chassis, fans, and 800 W redundant power supply) Chassis part#: 010-0165 (includes chassis, fans, and 1200 W single power supply) 	
Power supply	<ul style="list-style-type: none"> 1200 W (Advantech part#: 96PS-A1K2WPS2; included with Chassis IPC-623BP-1KZC) Or <ul style="list-style-type: none"> 800 W RPSU / 1200 W single power supply is included with the Rackmaster 20 slot 	
PCIe expansion slots	<ul style="list-style-type: none"> 10 PCIe x 16 2.0 slots (x16 mechanical, x16 electrical) 1 PCIe x16 2.0 slot (x16 mechanical, x4 electrical) 	
Notes	<ul style="list-style-type: none"> Choose power cord with IEC C19 plug for Advantech IPC-623BP-1KZC chassis model. All the dust protectors from the front as well as the sides of the chassis must be removed from the Advantech IPC-623 chassis. The Advantech IPC-623 chassis fans must run at full speed. Smart fan must be disabled to run chassis fans at full speed. In the system BIOS, go to → Advanced → HW Monitor Tab → SYSFAN1 Smartfan Setting → and select DISABLE. Ensure to have the following settings for GPU. Go to the system BIOS main page → Chipset → System Agent (SA) Configuration → Graphics Configuration → and select: <ul style="list-style-type: none"> Primary Display → AUTO Internal Graphics → AUTO (select Enabled for console) In the system BIOS, go to Chipset → System Agent (SA) Configuration → Above 4GB MMIO BIOS Assignment → and select Enabled. On-board console support with D-Series controller. Requires 3.05 or later drivers. Card placement shown in the configuration table must be followed for better system ventilation. Any unused slots must be installed with solid brackets for proper system ventilation. 	

Configurations

Slot	D-Series based controller		Third-party based controller	
	Main	Option	Main	Option
PPCIEX4_1	N/A		N/A	
P1PCIEX16_1	MURAI PXI-E4JF	A	Third-party graphics hardware	-
P1PCIEX16_2	MURAI PXI-E4JF	A	MURAI PXI-E4JF	A
P1PCIEX16_3	MURAI PXI-E4JF	A	MURAI PXI-E4JF	A
P1PCIEX16_4	D1480	B	Third-party graphics hardware	A
P1PCIEX16_5	MURAI PXI-E4JF	A	MURAI PXI-E4JF	A
P2PCIEX16_1	MURAI PXI-E4JF	A	Third-party graphics hardware	A
P2PCIEX16_2	MURAI PXI-E4JF	A	MURAI PXI-E4JF	A
P2PCIEX16_3	D1480	B	MURAI PXI-E4JF	A
P2PCIEX16_4	D1480	B	Third-party graphics hardware	A
P2PCIEX16_5	D1480	B	MURAI PXI-E4JF	A

Performance considerations with D-Series controller

Slot	Connectivity	Configuration 1	Configuration 2	Configuration 3	Configuration 4
PPCIEX4_1	x4	N/A	-	-	-
P1PCIEX16_1	x16	A	-	-	-
P1PCIEX16_2	x16	A	-	-	-
P1PCIEX16_3	x16	A	-	-	-
P1PCIEX16_4	x16	B*	-	-	-
P1PCIEX16_5	x16	A	-	-	-
P2PCIEX16_1	x16	A	-	-	-
P2PCIEX16_2	x16	A	-	-	-
P2PCIEX16_3	x16	B*	-	-	-
P2PCIEX16_4	x16	B*	-	-	-
P2PCIEX16_5	x16	B*	-	-	-

Note: * The backplane has a single PCIe x16 Gen3 connection to the CPU.

* The maximum stream bandwidth to a single GPU is limited to 6 GB/s.

Option	Product
A	MURAI PXI-E4SF, MURAI PXI-E4SHF, MURAI PXI-D2MF, MURAI PXI-D2MHF, MURAI PXI-E2MF, MURAI PXI-E2MHF, MURAI PXI-D4JF, MURAI PXI-D4JHF, MURAI PXI-E4JF, or MURAI PXI-E4JHF
B	D1450 or D1480

Motherboard layout



Advantech PCE-5B19 with PCE-7131 / PCE-7129

	D-Series based controllers	Third-party based controllers
Validated	Yes	No foreseeable compatibility issues
Maximum number of cards supported	15	
Maximum supported Mura IPX Series	14	
Maximum supported D-Series	4	
Motherboard	Advantech PCE-7131 / PCE-7129 (SHB) Advantech PCE-5B19 (Backplane)	
Chipset	Intel C246 (PCE-7131 SHB) Intel C236 (PCE-7129 SHB)	
Processor	Advantech PCE-7131 <ul style="list-style-type: none"> Intel® Xeon® E-2278GE CPU @ 3.30 GHz, or Intel® Core™ i7-9700E CPU @ 2.60GHz Advantech PCE-7129 <ul style="list-style-type: none"> Intel® Core™ i7-6770S, 3.40 GHz 	
Heatsink (for CPU)	2U CPU cooler	
System BIOS version	5.13, 2020-04-09 (PCE-7131) 5.12, 2018-03-13 (PCE-7129)	
System memory	32 GB DDR4 ECC Memory (Intel Xeon E-2278GE) 32 GB DDR4 non-ECC memory (Intel i7-9700E/i7-6770S)	
Chassis	Advantech IPC-623 4U rack mount <ul style="list-style-type: none"> Chassis part#: IPC-623BP-1KZC (for single power supply; includes chassis, fans and 1200 W power supply) Or Rackmaster 20 slot Chassis <ul style="list-style-type: none"> Chassis part#: 010-0163 (includes chassis, fans, and 800 W redundant power supply) Chassis part#: 010-0165 (includes chassis, fans, and 1200 W single power supply) 	
Power supply	<ul style="list-style-type: none"> 850 W / 1200 W single power supply with Advantech IPC-623 Enermax 1200 W (Part#: EPF1200EW; for Advantech IPC-623BP-00XBE purchased separately) EVGA 850 W (Part#: 220-G3-0850-X1; for Advantech IPC-623BP-00XBE purchased separately) 1200 W (Advantech part#: 96PS-A1K2WPS2; included with Chassis IPC-623BP-1KZC) Or <ul style="list-style-type: none"> 800 W RPSU / 1200 W single power supply included with the Rackmaster 20 slot 	
PCIe expansion slots	<ul style="list-style-type: none"> 17 PCIe x 16 3.0 slots (x16 mechanical, x16 electrical) 1 PCIe x16 3.0 slot (x16 mechanical, x4 electrical) 	
Notes	<ul style="list-style-type: none"> Choose a power cord with IEC C19 plug for the Advantech IPC-623BP-1KZC chassis model. All the dust protectors from the front as well as the sides of the chassis must be removed from the Advantech IPC-623 chassis. The Advantech IPC-623 chassis fans must run at full speed. The P1PCIE1 x4 slot is unusable due to the adjacent SHB slot. The P2PCIE1 x16 and P2PCIE2x16 slots are unusable due to mechanical conflict with the SHB CPU fan. Card placement shown in the configuration table must be followed for better system ventilation. Any unused slots must be installed with solid brackets for proper system ventilation. Ensure to have the following settings for GPU. Go to the system BIOS main page → Chipset System Agent (SA) Configuration → Graphics Configuration → and select: <ul style="list-style-type: none"> Primary Display → AUTO Internal Graphics → AUTO (select Enabled for Console) In the system BIOS, go to Chipset → System Agent (SA) Configuration → Above 4GB MMIO BIOS Assignment → and select Enabled. On-board console support with D-Series controller. Requires 3.05 or later drivers. 	

Configurations

Slot	D-Series based controller		Third-party based controller	
	Main	Option	Main	Option
P1PCIE_1	N/A		N/A	
P2PCIE_1	N/A		N/A	
P2PCIE_2	N/A		N/A	
P3PCIE_1	MURAI PXI-E4JF	A	Third-party graphics hardware	A
P3PCIE_2	MURAI PXI-E4JF	A	MURAI PXI-E4JF	A
P3PCIE_3	MURAI PXI-E4JF	A	MURAI PXI-E4JF	A
P3PCIE_4	MURAI PXI-E4JF	A	MURAI PXI-E4JF	A
P3PCIE_5	MURAI PXI-E4JF	A	Third-party graphics hardware	A
P4PCIE_1	MURAI PXI-E4JF	A	MURAI PXI-E4JF	A
P4PCIE_2	MURAI PXI-E4JF	A	MURAI PXI-E4JF	A
P4PCIE_3	MURAI PXI-E4JF	A	MURAI PXI-E4JF	A
P4PCIE_4	MURAI PXI-E4JF	A	MURAI PXI-E4JF	A
P4PCIE_5	MURAI PXI-E4JF	A	MURAI PXI-E4JF	A
P5PCIE_1	MURAI PXI-E4JF	A	MURAI PXI-E4JF	A
P5PCIE_2	D1480	B	MURAI PXI-E4JF	A
P5PCIE_3	D1480	B	MURAI PXI-E4JF	A
P5PCIE_4	D1480	B	Third-party graphics hardware	A
P5PCIE_5	D1480	B	Third-party graphics hardware	A

Performance considerations with D-Series controller

Slot	Connectivity	Configuration 1	Configuration 2	Configuration 3	Configuration 4
P1PCIE_1	x4	N/A	-	-	-
P2PCIE_1	x16	N/A	-	-	-
P2PCIE_2	x16	N/A	-	-	-
P3PCIE_1	x16	A	-	-	-
P3PCIE_2	x16	A	-	-	-
P3PCIE_3	x16	A	-	-	-
P3PCIE_4	x16	A	-	-	-
P3PCIE_5	x16	A	-	-	-
P4PCIE_1	x16	A	-	-	-
P4PCIE_2	x16	A	-	-	-
P4PCIE_3	x16	A	-	-	-
P4PCIE_4	x16	A	-	-	-
P4PCIE_5	x16	A	-	-	-
P5PCIE_1	x16	A	-	-	-
P5PCIE_2	x16	B	-	-	-
P5PCIE_3	x16	B	-	-	-
P5PCIE_4	x16	B	-	-	-
P5PCIE_5	x16	B	-	-	-

Note: * The backplane has a single PCIe x16 Gen3 connection to the CPU.

* The maximum stream bandwidth is limited to 12 GB/s.

Option	Product
A	MURAI PXI-E4SF, MURAI PXI-E4SHF, MURAI PXI-D2MF, MURAI PXI-D2MHF, MURAI PXI-E2MF, MURAI PXI-E2MHF, MURAI PXI-D4JF, MURAI PXI-D4JHF, MURAI PXI-E4JF, or MURAI PXI-E4JHF
B	D1450 or D1480

Motherboard layout

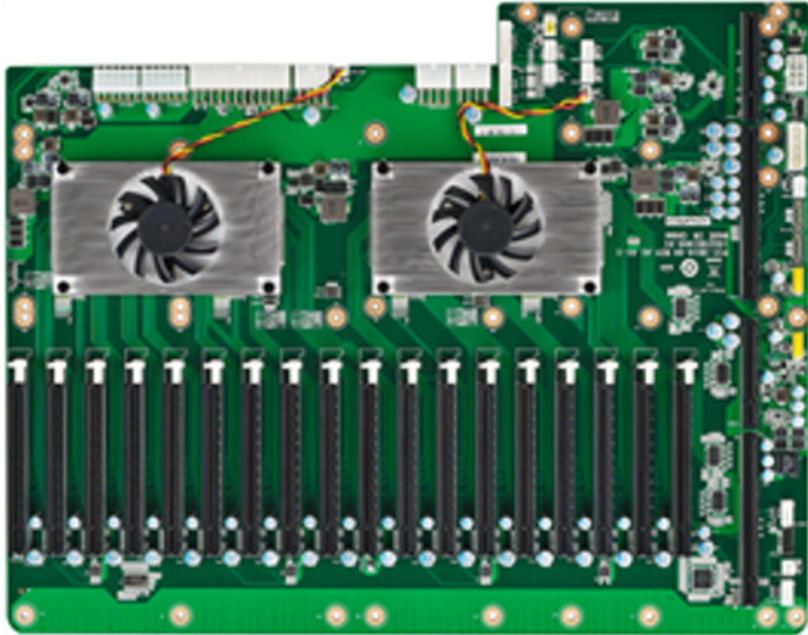

Asrock C621A WS

	D-Series based controllers	Third-party based controllers
Validated	Yes	No foreseeable compatibility issues
Maximum number of cards supported	7	
Maximum supported Mura IPX Series	6	
Maximum supported D-Series	4	
Validated OS	Windows 10 Enterprise LTSC; Version 10.0.19044 Build 19044	
Motherboard	Asrock C621A WS	
Chipset	Intel C621A	
Processor	Intel® Xeon® W-3323 CPU @ 3.50 GHz	
Heatsink (for CPU)	LGA 4189	
System BIOS version	L1.27, 2023-01-06	
System memory	32 GB (8 x 4 GB 2666 MHz ECC DDR4 RDIMM)	
Chassis	Chenbro RM41300-FS81	
Power supply	850 W (Part#: EVGA Supernova 850G3)	
PCIe expansion slots	<ul style="list-style-type: none"> ▪ 4 PCIe x16 4.0 slots ▪ 3 PCIe x8 4.0 slots 	
Notes	<ul style="list-style-type: none"> ▪ The chassis must be ordered from Chenbro. Power supply isn't included with the chassis. ▪ Only the front chassis fan that comes with the Chenbro chassis must be changed to: <ul style="list-style-type: none"> ▪ 120 mm x 120 mm x 25 mm 113 CFM ▪ The chassis fans must run at full speed. ▪ The dust protection filter in the front door must be removed for proper system ventilation. ▪ In the system BIOS, go to Advanced → Onboard VGA and select Auto. ▪ Ensure to have the following default settings for Above 4G Decoding. In the system BIOS, go to Advanced → PCI Subsystem Configuration, then set Above 4G Decoding to Enabled. ▪ On-board console support with D-Series controller. Requires 3.05 or later drivers. 	

Configurations

Slot	D-Series based controller		Third-party based controller	
	Main	Option	Main	Option
PCIE1	D1480	B	Third-party graphics hardware	-
PCIE2	MURAIPIXI-E4JHF	A	MURAIPIXI-E4JHF	A
PCIE3	D1480	A, B	Third-party graphics hardware	A
PCIE4	MURAIPIXI-E4JHF	A	MURAIPIXI-E4JHF	A
PCIE5	D1480	A, B	Third-party graphics hardware	A
PCIE6	MURAIPIXI-E4JHF	A	MURAIPIXI-E4JHF	A
PCIE7	D1480	A, B	Third-party graphics hardware	A

Performance considerations with D-Series controller

Slot	Connectivity	Configuration 1	Configuration 2	Configuration 3	Configuration 4
PCIE1	x16	B	B	B	B
PCIE2	x0 / x8	A	A	A	A
PCIE3	x16 / x8	A	A	A	B
PCIE4	x0 / x8	A	A	A	A
PCIE5	x16 / x8	A	A	B	B
PCIE6	x0 / x8	A	A	A	A
PCIE7	x16 / x8	A	B	A	B

Note: * Shared slots are 2&3, 4&5, and 6&7.

Option	Product
A	MURAI PXI-E4SF, MURAI PXI-E4SHF, MURAI PXI-D2MF, MURAI PXI-D2MHF, MURAI PXI-E2MF, MURAI PXI-E2MHF, MURAI PXI-D4JF, MURAI PXI-D4JHF, MURAI PXI-E4JF, or MURAI PXI-E4JHF
B	D1450 or D1480

Motherboard layout

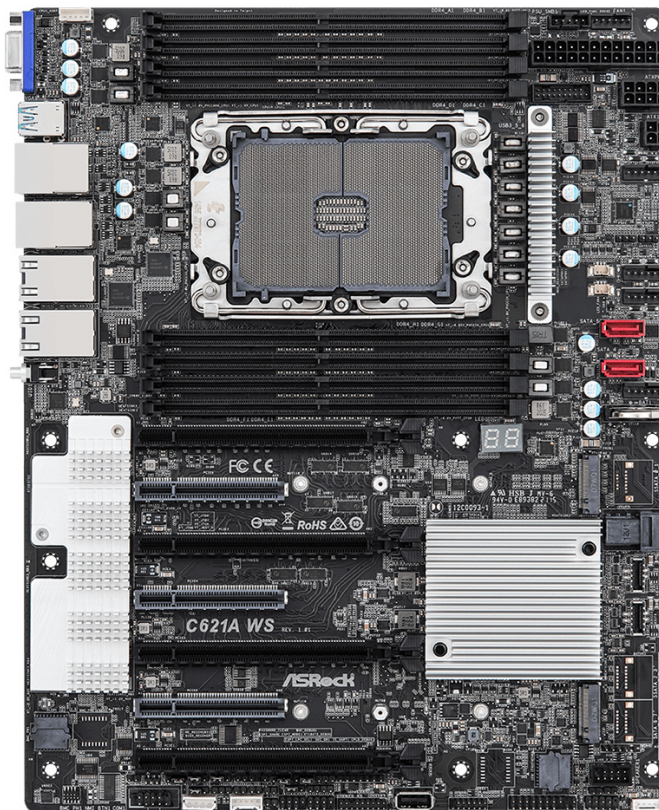

Asrock Rack ROMED8-2T

	D-Series based controllers	Third-party based controllers
Validated	Yes	No foreseeable compatibility issues

Maximum number of cards supported	7
Maximum supported Mura IPX Series	6
Maximum supported D-Series	4
Motherboard	Asrock Rack ROMED8-2T
Chipset	SoC
Processor	AMD EPYC 7232P @ 3.1 GHz
Heatsink (for CPU)	SP3
System BIOS version	P1.30, 2020-08-11
System memory	32 GB DDR4 RDIMM
Chassis	Chenbro RM41300-FS81 (includes fans)
Power supply	850 W (Part#: EVGA Supernova 850G3)
PCIe expansion slots	<ul style="list-style-type: none"> 7 PCIe x16 4.0 slots
Notes	<ul style="list-style-type: none"> The chassis must be ordered from Chenbro. Power supply isn't included with the chassis. Only the front chassis fan that comes with the Chenbro chassis must be changed to: <ul style="list-style-type: none"> 120 mm x 120 mm x 25 mm 113 CFM (D1400 controller) The chassis fans must run at full speed. The dust protection filter in the front door must be removed for proper system ventilation. To use the on-board console, in the system BIOS, go to Advanced → Chipset Configuration → OnBrd/Ext VGA and select Onboard. PCIe2 Gen4 x16 link shared with M2_1/OCU1/OCU2/SATA_4_7 by two 3-pin PE8_SEL/PE16_SEL jumpers. Ensure to have M2_1/SATA_4_7/OCU1/OCU2 set to Disabled (default). Ensure to have the following default settings for Above 4G Decoding. In the system BIOS, go to Advanced → Chipset Configuration, then set Above 4G Decoding to Enabled. On-board console support with D-Series controller. Requires 3.06 or later drivers. Install the display driver "video_win_v112_Sep2021_PV" for on-board ASPEED AST2500 from Intel website for the console to work properly.

Configurations

Slot	D-Series based controller		Third-party based controller	
	Main	Option	Main	Option
PCIE1	D1480	B	Third-party graphics hardware	-
PCIE2	MURAI PXI-E4JHF	A	MURAI PXI-E4JHF	A
PCIE3	D1480	A, B	Third-party graphics hardware	A
PCIE4	MURAI PXI-E4JHF	A	MURAI PXI-E4JHF	A
PCIE5	D1480	A, B	Third-party graphics hardware	A
PCIE6	MURAI PXI-E4JHF	A	MURAI PXI-E4JHF	A
PCIE7	D1480	A, B	Third-party graphics hardware	A

Performance considerations with D-Series controller

Slot	Connectivity	Configuration 1	Configuration 2	Configuration 3	Configuration 4
PCIE1	x16	B	B	B	B
PCIE2*	x16 / x8	A	A	A	A
PCIE3	x16	A	A	B	B
PCIE4	x16	A	A	A	A
PCIE5	x16	A	B	B	B
PCIE6	x16	A	A	A	A
PCIE7	x16	A	A	A	B

Note: * PCIE2 Gen4 x16 link shared with M2_1/OCU1/OCU2/SATA_4_7 by two 3-pin PE8_SEL/PE16_SEL jumpers. For slot PCIE2 to run in x16 mode, M2_1/SATA_4_7/OCU1/OCU2 must be set to Disabled.

Option	Product
A	MURAI PXI-E4SF, MURAI PXI-E4SHF, MURAI PXI-D2MF, MURAI PXI-D2MHF, MURAI PXI-E2MF, MURAI PXI-E2MHF, MURAI PXI-D4JF, MURAI PXI-D4JHF, MURAI PXI-E4JF, or MURAI PXI-E4JHF
B	D1450 or D1480

Motherboard layout

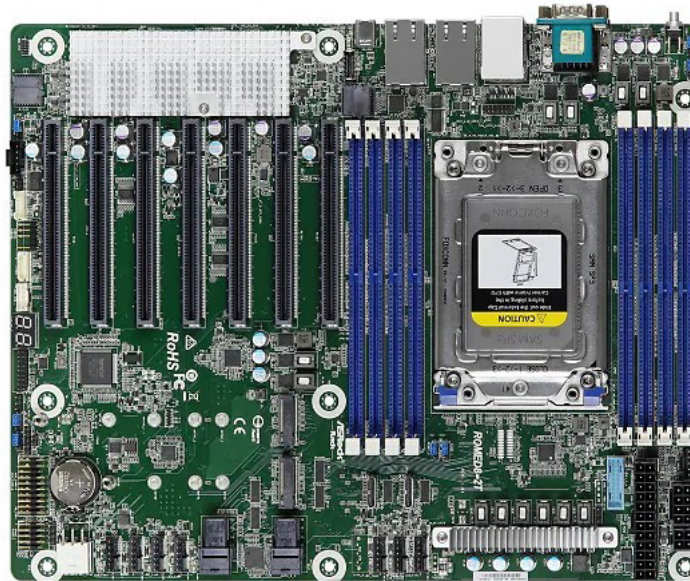

ASUS Pro WS W790E-SAGE SE

	D-Series based controllers	Third-party based controllers
Validated	Yes	No foreseeable compatibility issues
Maximum number of cards supported	7	
Maximum supported Mura IPX Series	6	
Maximum supported D-Series	4	
Validated OS	Windows 10 Enterprise LTSC; Version 10.0.19044 Build 19044	
Motherboard	Asus Pro WS W790E-SAGE SE	
Chipset	Intel W790	
Processor	Intel® Xeon® W5-3425 CPU @ 3.2 GHz	
Heatsink (for CPU)	LGA 4677 (Part#: Noctua NH-D9 DX-4677 4U)	
System BIOS version	0506, 2023-04-28	
System memory	128 GB (8 x 16 GB 4800 MHz ECC DDR5 RDIMM)	
Chassis	Rosewill RSV-L4000U 4U	
Power supply	1200 W (Enermax Revolution D.F.2 1200 W; Part#: ERS1200EWT)	
PCIe expansion slots	<ul style="list-style-type: none"> 7 PCIe x16 5.0 slots 	
Notes	<ul style="list-style-type: none"> The power supply isn't included with the chassis. The front fans inside the Rosewill chassis must be changed to: <ul style="list-style-type: none"> 3 x 120 mm x 120 mm x 25 mm 113 CFM. Ensure to have the VGA_SW switch Enabled on the motherboard. Ensure to have the following settings for Above 4G Decoding in the system BIOS: <ul style="list-style-type: none"> Go to Advanced → PCI Subsystem Settings → Above 4G Decoding → select Enabled. On-board console support with D-Series controller. Requires 3.05 or later drivers. 	

Configurations

Slot	D-Series based controller		Third-party based controller	
	Main	Option	Main	Option
PCIEX16(G5)_1	D1480	A, B	Third-party graphics hardware	A
PCIEX16(G5)_2	MURAIPIXI-E4JHF	A	MURAIPIXI-E4JHF	A
PCIEX16(G5)_3	D1480	A, B	Third-party graphics hardware	A
PCIEX16(G5)_4	MURAIPIXI-E4JHF	A	MURAIPIXI-E4JHF	A
PCIEX16(G5)_5	D1480	A, B	Third-party graphics hardware	A
PCIEX16(G5)_6	MURAIPIXI-E4JHF	A	MURAIPIXI-E4JHF	A
PCIEX16(G5)_7	D1480	B	Third-party graphics hardware	-

Performance considerations with D-Series controller

Slot	Connectivity	Configuration 1	Configuration 2	Configuration 3	Configuration 4
PCIEX16(G5)_1	x16	A	A	A	B
PCIEX16(G5)_2	x16	A	A	A	A
PCIEX16(G5)_3	x16	A	A	B	B
PCIEX16(G5)_4	x16	A	A	A	A
PCIEX16(G5)_5	x16	A	B	B	B
PCIEX16(G5)_6	x8	A	A	A	A
PCIEX16(G5)_7	x16	B	B	B	B

Option	Product
A	MURAI PXI-E4SF, MURAI PXI-E4SHF, MURAI PXI-D2MF, MURAI PXI-D2MHF, MURAI PXI-E2MF, MURAI PXI-E2MHF, MURAI PXI-D4JF, MURAI PXI-D4JHF, MURAI PXI-E4JF, or MURAI PXI-E4JHF
B	D1450 or D1480

Motherboard layout

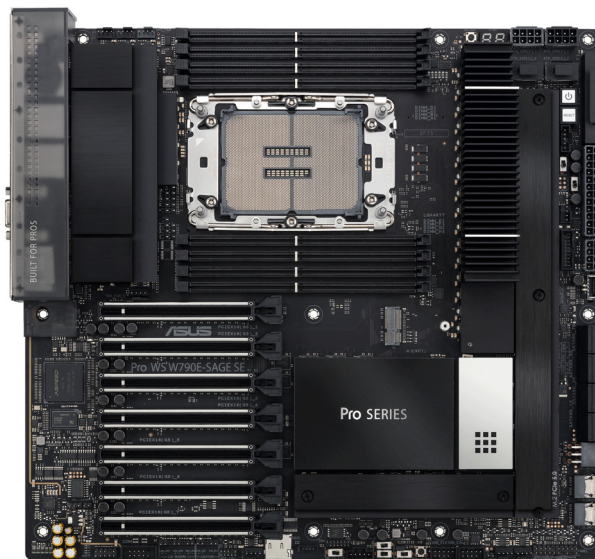

ASUS Pro WS WRX80E-SAGE SE WIFI

	D-Series based controllers	Third-party based controllers
Validated	Yes	No foreseeable compatibility issues
Maximum number of cards supported	7	
Maximum supported Mura IPX Series	6	
Maximum supported D-Series	4	
Validated OS	Windows 10 Enterprise LTSC; Version 10.0.19044 Build 19044	
Motherboard	Asus Pro WS WRX80E-SAGE SE WIFI	
Chipset	AMD WRX80	
Processor	AMD Ryzen Threadripper Pro 3955WX 3.9 GHz CPU	
Heatsink (for CPU)	sWRX8	
System BIOS version	1003, 2022-02-18	
System memory	64 GB (8 x 8 GB 2400 MHz DDR4 RDIMM)	
Chassis	Sliger CX4170a (order chassis fans separately)	
Power supply	1000 W (Part#: EVGA Supernova 1000GT)	
PCIe expansion slots	<ul style="list-style-type: none"> 7 PCIe x16 4.0 slots 	
Notes	<ul style="list-style-type: none"> The chassis must be ordered from Sliger. Power supply isn't included with the chassis. Chassis front fans must be ordered separately from Delta (three 120 mm x 120 mm x 25 mm 113 CFM; Part#: Delta AFB1212SH). The chassis fans must run at full speed. Ensure to have the following settings for Above 4G Decoding in the system BIOS: <ul style="list-style-type: none"> Go to Advanced → PCI Subsystem Settings → Above 4G Decoding → select Enabled. There are eight memory channels. Ensure to have at least one DIMM populated per memory channel for optimized performance. 	

Configurations

Slot	D-Series based controller		Third-party based controller	
	Main	Option	Main	Option
PCIEX16_1	D1480	B	Third-party graphics hardware	A
PCIEX16_2	MURAIPIXI-E4JHF	A	MURAIPIXI-E4JHF	A
PCIEX16_3	D1480	A, B	Third-party graphics hardware	-
PCIEX16_4	MURAIPIXI-E4JHF	A	MURAIPIXI-E4JHF	A
PCIEX16_5	D1480	A, B	Third-party graphics hardware	A
PCIEX16_6	MURAIPIXI-E4JHF	A	MURAIPIXI-E4JHF	A
PCIEX16_7	D1480	A, B	Third-party graphics hardware	A

Performance considerations with D-Series controller

Slot	Connectivity	Configuration 1	Configuration 2	Configuration 3	Configuration 4
PCIEX16_1	x16	B	B	B	B
PCIEX16_2	x16	A	A	A	A
PCIEX16_3	x16	A	A	B	B
PCIEX16_4	x16	A	A	A	A
PCIEX16_5	x16	A	B	B	B
PCIEX16_6	x16	A	A	A	A
PCIEX16_7	x16	A	A	B	B

Option	Product
A	MURAI PXI-E4SF, MURAI PXI-E4SHF, MURAI PXI-D2MF, MURAI PXI-D2MHF, MURAI PXI-E2MF, MURAI PXI-E2MHF, MURAI PXI-D4JF, MURAI PXI-D4JHF, MURAI PXI-E4JF, or MURAI PXI-E4JHF
B	D1450 or D1480

Motherboard layout

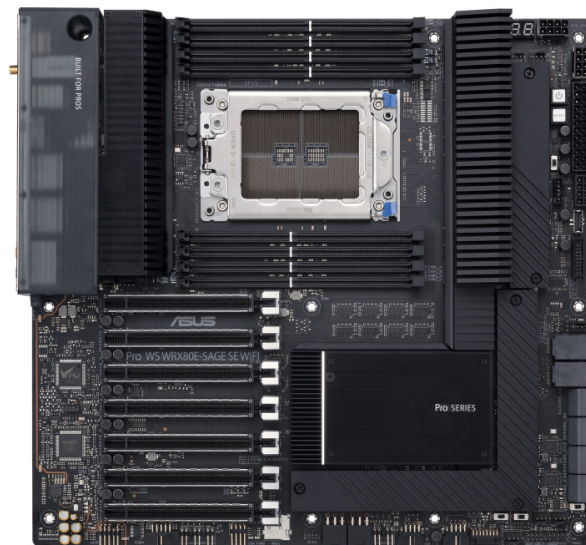

ASUS Pro WS X299 SAGE II

	D-Series based controllers	Third-party based controllers
Validated	Yes	No foreseeable compatibility issues
Maximum number of cards supported	7	
Maximum supported Mura IPX Series	6	
Maximum supported D-Series	4	
Motherboard	ASUS Pro WS X299 SAGE II	
Chipset	Intel X299	
Processor	Intel® Core™ i9-10900X CPU @ 3.70 GHz (X-series, 48 lane CPU), or Intel® Core™ i7-9800X CPU @ 3.80 GHz (X-series 44 lane CPU), or Intel® Core™ i9-9920X CPU @ 3.50 GHz (X-series, 44 lane CPU)	
Heatsink (for CPU)	LGA 2066	
System BIOS version	0702, 2020-06-10	
System memory	32 GB DDR4	
Chassis	Chenbro RM41300-FS81 (includes fans)	
Power supply	850 W (Part#: EVGA Supernova 850G3)	
PCIe expansion slots	<ul style="list-style-type: none"> 7 PCIe x16 3.0 / 2.0 slots 	
Notes	<ul style="list-style-type: none"> The chassis must be ordered from Chenbro. Power supply isn't included with the chassis. Only the front chassis fan that comes with the Chenbro chassis must be changed to: <ul style="list-style-type: none"> 120 mm x 120 mm x 25 mm 113 CFM (D1400 controller). The dust protection filter in the front door must be removed for proper system ventilation. The chassis fans must run at full speed. To change the fan speed, go to the system BIOS main page (EZ mode) → select QFan Control → select the header to which the fans are connected → change from Standard to Full Speed and apply the changes. Two dust protection filters present in front of the chassis must be removed for proper system ventilation. Ensure to have the following default settings for Above 4G Decoding. In the system BIOS, go to Advanced Mode → Boot, then set Above 4G Decoding to ON and set First VGA 4G Decode to Above_4G. Add-in board console support with D-Series controller. Requires 3.05 or later drivers. 	

Configurations

Slot	D-Series based controller		Third-party based controller	
	Main	Option	Main	Option
PCIEX16_1	D1480	B	Third-party graphics hardware	-
PCIEX16_2	MURAIPIXI-D4JF	A	MURAIPIXI-D4JF	A
PCIEX16_3	D1480	A, B	Third-party graphics hardware	A
PCIEX16_4	MURAIPIXI-D4JF	A	MURAIPIXI-D4JF	A
PCIEX16_5	D1480	A, B	Third-party graphics hardware	A
PCIEX16_6	MURAIPIXI-D4JF	A, C	MURAIPIXI-D4JF	A
PCIEX16_7	D1480	A, B	Third-party graphics hardware	A

Performance considerations with D-Series controller

Slot	Connectivity	Configuration 1	Configuration 2	Configuration 3	Configuration 4
PCIEX16_1	x16	B	B	B	B
PCIEX16_2	x8 / x4	A	A	A	A
PCIEX16_3	x16 / x8	A	A	B*	B*
PCIEX16_4	x8 / x0	A	A	A	A
PCIEX16_5	x16 / x8	A	B*	B*	B*
PCIEX16_6	x8 / x0	A	A	A	A
PCIEX16_7	x16 / x8	A	A	A	B*

Note: * The D-Series bandwidth is reduced to 6 GB/s instead of 12 GB/s when shared slots are used. However, the performance depends on the layout, the number of streams going to each D-Series, rendering done, and the intended usage. Shared slots are 2&3, 4&5, and 6&7.

Option	Product
A	MURAIPXI-E4SF, MURAIPXI-E4SHF, MURAIPXI-D2MF, MURAIPXI-D2MHF, MURAIPXI-E2MF, MURAIPXI-E2MHF, MURAIPXI-D4JF, MURAIPXI-D4JHF, MURAIPXI-E4JF, or MURAIPXI-E4JHF
B	D1450 or D1480
C	Matrox M9148 LP PCIe x16, Matrox M9140 LP PCIe x16, Matrox M9138 LP PCIe x16, Matrox M9128 LP PCIe x16, Matrox M9120 Plus LP PCIe x16, Matrox M9120 Plus LP PCIe x1, Matrox M9120 PCIe x16, NVIDIA Quadro P620, NVIDIA Quadro P600, NVIDIA Quadro P400, NVIDIA Quadro K620, AMD Radeon WX2100, or AMD Radeon Vega 8 (add-in card console options)

Motherboard layout

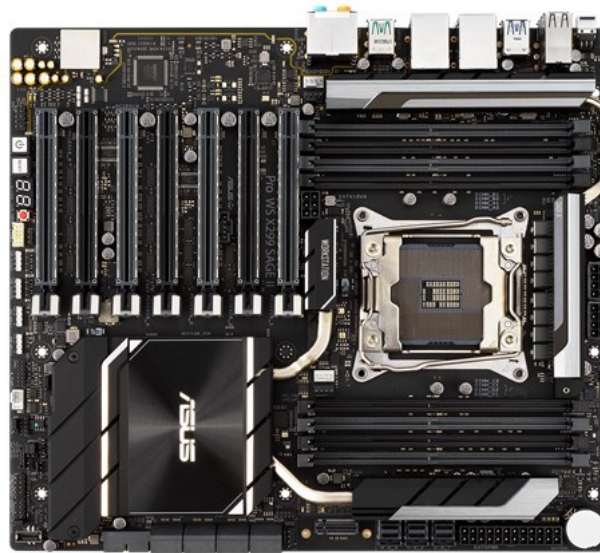

ASUS WS C422 PRO/SE

	D-Series based controllers	Third-party based controllers
Validated	Yes	No foreseeable compatibility issues
Maximum number of cards supported	4	
Maximum supported Mura IPX Series	3	
Maximum supported D-Series	4	
Motherboard	ASUS WS C422 PRO/SE	
Chipset	Intel C422	
Processor	Intel® Xeon® W-2133 CPU @ 3.60 GHz	
Heatsink (for CPU)	LGA 2066 for Intel® Xeon-W series	
System BIOS version	0702, 2018-06-14	
System memory	32 GB DDR4 RDIMM	
Chassis	Chenbro RM41300-FS81 (includes fans)	
Power supply	750 W (Part#: Corsair RM750x)	
PCIe expansion slots	<ul style="list-style-type: none"> ▪ 2 PCIe x16 3.0 slots (x16 mechanical, x16 electrical) ▪ 2 PCIe x16 3.0 slots (x16 mechanical, x16 / x8 electrical) ▪ 1 PCIe x4 3.0 slot (x4 mechanical, x4 electrical) 	
Notes	<ul style="list-style-type: none"> ▪ The chassis must be ordered from Chenbro. Power supply isn't included with the chassis. ▪ Make sure you have the following default settings for Above 4G Decoding. In the system BIOS main page, go to Boot, then set Above 4G Decoding to ON and First VGA 4G Decode to Auto. ▪ To use the on-board graphics, make sure the 3-pin VGA_SW1 jumper is set to Enable on the motherboard. Then install the VGA bracket cable that came with the motherboard in an empty slot and connect to the internal VGA connector VGA_HDR1 on the motherboard. 	

Configurations

Slot	D-Series based controller		Third-party based controller	
	Main	Options	Main	Options
PCIEX16_1	D1480	B	Third-party graphics hardware	-
PCIEX16_2	D1480	A, B	Third-party graphics hardware	A
PCIEX4_1	N/A		N/A	
PCIEX16_3	MURAIPIXI-E4JF	A, B	MURAIPIXI-E4JF	A
PCIEX16_4	MURAIPIXI-E4JF	A, B	MURAIPIXI-E4JF	A

Performance considerations with D-Series controller

Slot	Connectivity	Configuration 1	Configuration 2	Configuration 3
PCIEX16_1	x16	B	B	B
PCIEX16_2	x16	A	A	B
PCIEX4_1	x4	N/A	N/A	N/A
PCIEX16_3	x16 / x8	A	A	B*
PCIEX16_4	x8 / x0	A	A	A

Note: * The GPU PCIe bandwidth is reduced to 6 GB/s instead of 12 GB/s when shared slots are used. Shared slots are 3 and 4.

Option	Product
A	MURAI PXI-E4SF, MURAI PXI-E4SHF, MURAI PXI-D2MF, MURAI PXI-D2MHF, MURAI PXI-E2MF, MURAI PXI-E2MHF, MURAI PXI-D4JF, MURAI PXI-D4JHF, MURAI PXI-E4JF, or MURAI PXI-E4JHF
B	D1450 or D1480

Motherboard layout



ASUS WS C422 SAGE 10G

	D-Series based controllers	Third-party based controllers
Validated	Yes	No foreseeable compatibility issues
Maximum number of cards supported	7	
Maximum supported Mura IPX Series	6	
Maximum supported D-Series	4	
Motherboard	ASUS WS C422 SAGE/10G	
Chipset	Intel C422	
Processor	Intel® Xeon® W-2123 CPU @ 3.6 GHz	
Heatsink (for CPU)	LGA 2066	
System BIOS version	3405, 3/22/2021	
System memory	32 GB DDR4 RDIMM	
Chassis	Chenbro RM41300-FS81	
Power supply	850 W (Part#: EVGA Supernova 850G3; use with Chenbro RM41300-FS81)	
PCIe expansion slots	<ul style="list-style-type: none"> 7 PCIe x 16 3.0 slots (x16 mechanical, x16 / x8 electrical) 	
Notes	<ul style="list-style-type: none"> The chassis must be ordered from Chenbro. Power supply isn't included with the chassis. Only the front chassis fan that comes with the Chenbro chassis must be changed to: <ul style="list-style-type: none"> 120 mm x 120 mm x 25 mm 113 CFM (D1400 controller). The dust protection filter in the front door must be removed for proper system ventilation. The chassis fans must run at full speed. To change the fan speed, go to the system BIOS main page (EZ mode) → select QFan Control → select the header to which the fans are connected → change from Standard to Full Speed and apply the changes. Ensure to have the following settings for Above 4G Decoding in the system BIOS: <ul style="list-style-type: none"> Go to Advanced Mode → Boot, then set Above 4G Decoding to ON and set First VGA 4G Decode to Above_4G. Go to Advanced Mode → PCI Subsystem Settings, then set Above 4G Decoding to ENABLED. 	

Configurations

Slot	D-Series based controller		Third-party based controller	
	Main	Option	Main	Option
PCIEX16_1	D1480	B	Third-party graphics hardware	-
PCIEX16_2	MURAI PXI-E4JHF	A	MURAI PXI-E4JHF	A
PCIEX16_3	D1480	A, B	Third-party graphics hardware	A
PCIEX16_4	MURAI PXI-E4JHF	A	MURAI PXI-E4JHF	A
PCIEX16_5	D1480	A, B	Third-party graphics hardware	A
PCIEX16_6	MURAI PXI-E4JHF	A, C	MURAI PXI-E4JHF	A
PCIEX16_7	D1480	A, B	Third-party graphics hardware	A

Performance considerations with D-Series controller

Slot	Connectivity	Configuration 1	Configuration 2	Configuration 3	Configuration 4
PCIEX16_1	x16	B	B	B	B
PCIEX16_2	x8 / x0	A	A	A	A
PCIEX16_3	x16 / x8	A	A	B*	B*
PCIEX16_4	x8 / x0	A	A	A	A
PCIEX16_5	x16 / x8	A	B*	B*	B*
PCIEX16_6	x8 / x0	A	A	A	A
PCIEX16_7	x16 / x8	A	A	A	B*

Note: * The GPU bandwidth is reduced to 6 GB/s instead of 12 GB/s when shared slots are used. Shared slots are 2&3, 4&5, and 6&7.

Option	Product
A	MURAI PXI-E4SF, MURAI PXI-E4SHF, MURAI PXI-D2MF, MURAI PXI-D2MHF, MURAI PXI-E2MF, MURAI PXI-E2MHF, MURAI PXI-D4JF, MURAI PXI-D4JHF, MURAI PXI-E4JF, or MURAI PXI-E4JHF
B	D1450 or D1480
C	Matrox M9148 LP PCIe x16, Matrox M9140 LP PCIe x16, Matrox M9138 LP PCIe x16, Matrox M9128 LP PCIe x16, Matrox M9120 Plus LP PCIe x16, Matrox M9120 Plus LP PCIe x1, Matrox M9120 PCIe x16, NVIDIA Quadro P620, NVIDIA Quadro P600, NVIDIA Quadro P400, NVIDIA Quadro K620, AMD Radeon WX2100, or AMD Radeon Vega 8 (add-in card console options)

Motherboard layout



ASUS WS C621E SAGE

	D-Series based controllers	Third-party based controllers
Validated	Yes	No foreseeable compatibility issues
Maximum number of cards supported	7	
Maximum supported Mura IPX Series	6	
Maximum supported D-Series	4	
Motherboard	ASUS WS C621 SAGE	
Chipset	Intel C621	
Processor	Intel® Xeon® Bronze 3104 Dual CPU @ 1.70 GHz, or Intel® Xeon® Silver 4210R Dual CPU @ 2.40 GHz	
Heatsink (for CPU)	LGA 3647	
System BIOS version	6102, 2019-12-17	
System memory	32 GB DDR4 ECC-RDIMM	
Chassis	Chenbro RM41300-FS81	
Power supply	850 W (Part#: EVGA Supernova 850G3)	
PCIe expansion slots	<ul style="list-style-type: none"> ▪ 3 PCIe x16 3.0 slots (x16 mechanical, x16 electrical) ▪ 2 PCIe x16 3.0 slots (x16 mechanical, x16 / x8 electrical) ▪ 2 PCIe x16 3.0 slots (x16 mechanical, x8 electrical) 	
Notes	<ul style="list-style-type: none"> ▪ The chassis must be ordered from Chenbro. Power supply isn't included with the chassis. ▪ Only the front chassis fan that comes with the Chenbro chassis must be changed to 120 mm x 120 mm x 25 mm 113 CFM. ▪ The chassis fans must run at full speed. To change the fan speed, go to the system BIOS main page (EZ mode) → select QFan Control → select the header to which the fans are connected → change from Standard to Full Speed and apply the changes. ▪ The dust protection filter in the front door must be removed for proper system ventilation. ▪ To use the on-board graphics, make sure the 3-pin VGA_SW1 jumper is set to Enable on the motherboard. Then, install the VGA bracket cable that comes with the motherboard in an empty slot and connect to the internal VGA connector VGA_HDR1 on the motherboard. ▪ In the system BIOS, go to → Platform Configuration → Miscellaneous Configuration → then set Active Video to OFFboard. ▪ Make sure to have the following default settings for Above 4G Decoding. In the system BIOS, go to Advanced → PCI Subsystem Configuration, then set Above 4G Decoding to Enabled and set First VGA 4G Decode to Auto. ▪ On-board console support with D-Series controller. Requires 3.05 or later drivers. 	

Configurations

Slot	D-Series based controller		Third-party based controller	
	Main	Option	Main	Option
PCIEX16_1	D1480	B	Third-party graphics hardware	-
PCIEX16_2	MURAIPIXI-E4JHF	A	MURAIPIXI-E4JHF	A
PCIEX16_3	D1480	A, B	Third-party graphics hardware	A
PCIEX16_4	MURAIPIXI-E4JHF	A	MURAIPIXI-E4JHF	A
PCIEX16_5	D1480	A,B	Third-party graphics hardware	A
PCIEX16_6	MURAIPIXI-E4JHF	A	MURAIPIXI-E4JHF	A
PCIEX16_7	D1480	A, B	Third-party graphics hardware	A

Performance considerations with D-Series controller

Slot	Connectivity	Configuration 1	Configuration 2	Configuration 3	Configuration 4
PCIEX16_1	x16	B	B	B	B
PCIEX16_2	x8	A	A	A	A
PCIEX16_3	x16 / x8	A	A	A	B*
PCIEX16_4	x8 / x0	A	A	A	A
PCIEX16_5	x16	A	B	B	B
PCIEX16_6	x8	A	A	A	A
PCIEX16_7	x16	A	A	B	B

Note: * The GPU bandwidth is reduced to 6 GB/s instead of 12 GB/s when shared slots are used. Shared slots are 3 & 4.

Option	Product
A	MURAIPIXI-E4SF, MURAIPIXI-E4SHF, MURAIPIXI-D2MF, MURAIPIXI-D2MHF, MURAIPIXI-E2MF, MURAIPIXI-E2MHF, MURAIPIXI-D4JF, MURAIPIXI-D4JHF, MURAIPIXI-E4JF, or MURAIPIXI-E4JHF
B	D1450 or D1480

Motherboard layout

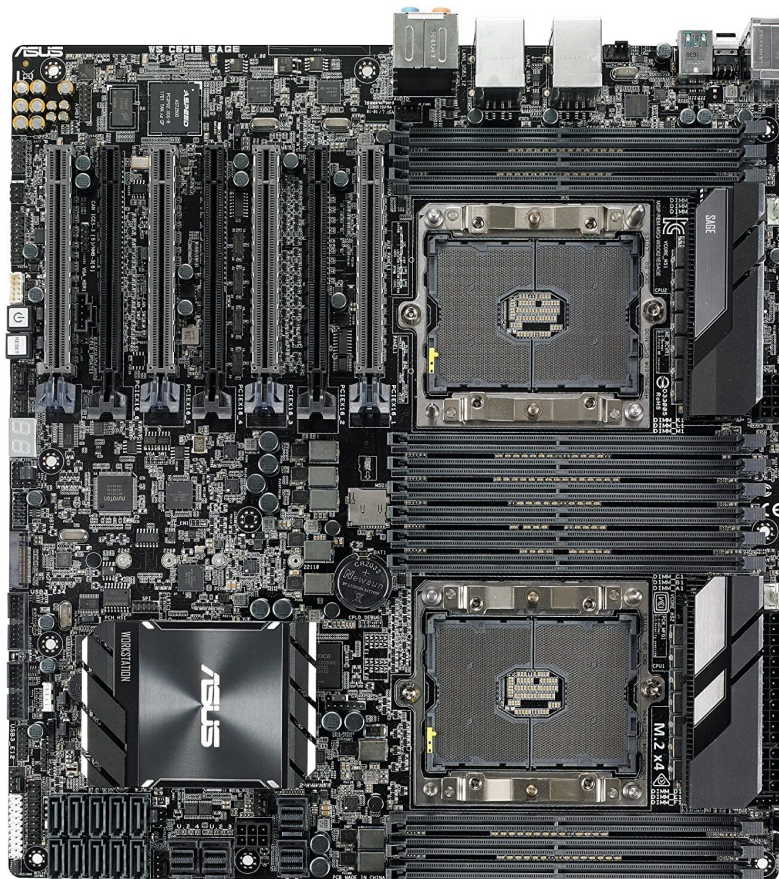

Gigabyte C246-WU4

	D-Series based controllers	Third-party based controllers
Validated	Yes	No foreseeable compatibility issues
Maximum number of cards supported	4	
Maximum supported Mura IPX Series	3	
Maximum supported D-Series	2	
Validated OS	Windows 10 Enterprise LTSC; Version 10.0.19044 Build 19044	
Motherboard	Gigabyte C246-WU4	
Chipset	Intel C246	
Processor	Intel® Core® i5-9600K CPU @ 3.70 GHz	
Heatsink (for CPU)	LGA-1151	
System BIOS version	F5, 2019-06-05	
System memory	32 GB (2 x 16 GB 2133 MHz DDR4)	
Chassis	Chenbro RM41300-FS81	
Power supply	750 W (Part#: Corsair RM750x)	
PCIe expansion slots	<ul style="list-style-type: none"> ▪ 1 PCIe x16 3.0 slots (x16 / x8) ▪ 1 PCIe x16 3.0 slots (x0 / x8) ▪ 2 PCIe x16 3.0 slot (x4) 	
Notes	<ul style="list-style-type: none"> ▪ The chassis must be ordered from Chenbro. Power supply isn't included with the chassis. ▪ The chassis fans must run at full speed. ▪ Ensure to have the following settings for Onboard VGA in the system BIOS: Go to Advanced → Chipset → Internal Graphics → and select Enabled. ▪ On-board console support with D-Series controller. Requires 3.05 or later drivers. ▪ The PCIe4_2 slot becomes unavailable when PCIe SSD is installed in the M2M connector. 	

Configurations

Slot	D-Series based controller		Third-party based controller	
	Main	Options	Main	Options
PCIEX16	D1480	B	Third-party graphics hardware	-
PCIEX4_1	MURAIPIXI-E4JHF	A	MURAIPIXI-E4JHF	A
PCIEX8	D1480	A, B	Third-party graphics hardware	A
PCIEX4-2	MURAIPIXI-E4JHF	A	MURAIPIXI-E4JHF	A

Performance considerations with D-Series controller

Slot	Connectivity	Configuration 1	Configuration 2
PCIEX16*	x16 / x8	B	B
PCIEX4_1	x4	A	A
PCIEX8*	x0 / x8	A	B
PCIEX4-2	x4	A	A

Note: * Shared slots are PCIEX16 & PCIEX8. When the PCIEX8 slot is populated, the PCIEX16 slot operates at up to x8 mode.

Option	Product
A	MURAI PXI-E4SF, MURAI PXI-E4SHF, MURAI PXI-D2MF, MURAI PXI-D2MHF, MURAI PXI-E2MF, MURAI PXI-E2MHF, MURAI PXI-D4JF, MURAI PXI-D4JHF, MURAI PXI-E4JF, or MURAI PXI-E4JHF
B	D1450 or D1480

Motherboard layout

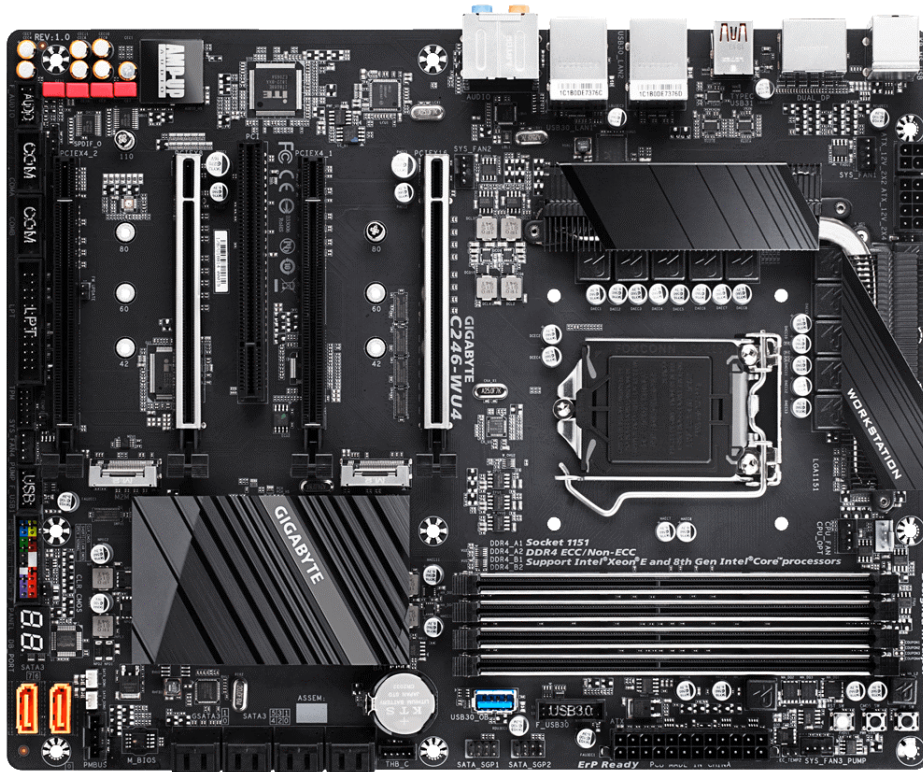

Gigabyte MU72-SU0

	D-Series based controllers	Third-party based controllers
Validated	Yes	No foreseeable compatibility issues

Maximum number of cards supported	7
Maximum supported Mura IPX Series	6
Maximum supported D-Series	4
Validated OS	Windows 10 Enterprise LTSC; Version 10.0.19045 Build 19045
Motherboard	Gigabyte MU72-SU0
Chipset	Intel C621A
Processor	Intel® Xeon® Silver 4310 CPU @ 2.10 GHz
Heatsink (for CPU)	LGA-4189
System BIOS version	F11, 2022-01-12
System memory	32 GB (8 x 4 GB 2666 MHz DDR4 ECC RDIMM)
Chassis	PClcase IPC-C4FB-H
Power supply	800 W redundant power supply (Part#: PIST1080-EPSH-80)
PCIe expansion slots	<ul style="list-style-type: none"> ▪ 3 PCIe x16 4.0 slots (x16 / x8) ▪ 3 PCIe x16 4.0 slots (x0 / x8) ▪ 1 PCIe x16 4.0 slot
Notes	<ul style="list-style-type: none"> ▪ Requires three 92 mm x 92 mm x 25 mm 118 CFM (Sanyo Denki part#: 9HV0912P4G001) OR three 92 mm x 92 mm x 38 mm 141 CFM middle chassis fans (Sanyo Denki part#: 9GA0912P1H03). ▪ The ambient temperature must not exceed 35 degrees centigrade if used with 118 CFM middle chassis fans. ▪ The system fan must run at full speed. ▪ Ensure to have the following settings for Onboard VGA in the system BIOS: Go to Advanced → Chipset → Miscellaneous Configurations → Active Video → and select Onboard Device. ▪ On-board console support with D-Series controller. Requires 3.05 or later drivers. ▪ Ensure to have the following default settings for Above 4G Decoding. In the system BIOS, go to Advanced → PCI Subsystem Settings → Above 4G Decoding → and select Enabled (default).

Configurations

Slot	D-Series based controller		Third-party based controller	
	Main	Options	Main	Options
SLOT1 PCIE GEN4 x8	MURAI PXI-E4JHF	A	MURAI PXI-E4JHF	A
SLOT2 PCIE GEN4 x16	D1480	A, B	Third-party graphics hardware	A
SLOT3 PCIE GEN4 x8	MURAI PXI-E4JHF	A	MURAI PXI-E4JHF	A
SLOT4 PCIE GEN4 x16	D1480	A, B	Third-party graphics hardware	A
SLOT5 PCIE GEN4 x8	MURAI PXI-E4JHF	A	MURAI PXI-E4JHF	A
SLOT6 PCIE GEN4 x16	D1480	A, B	Third-party graphics hardware	A
SLOT7 PCIE GEN4 x16	D1480	B	Third-party graphics hardware	-

Performance considerations with D-Series controller

Slot	Connectivity	Configuration 1	Configuration 2	Configuration 3	Configuration 4
SLOT1 PCIE GEN4 x8	x0 / x8	A	A	A	A
SLOT2 PCIE GEN4 x16	x16 / x8	A	B	B	B
SLOT3 PCIE GEN4 x8	x0 / x8	A	A	A	A
SLOT4 PCIE GEN4 x16	x16 / x8	A	A	B	B
SLOT5 PCIE GEN4 x8	x0 / x8	A	A	A	A
SLOT6 PCIE GEN4 x16	x16 / x8	A	A	A	B
SLOT7 PCIE GEN4 x16	x16	B	B	B	B

Note: Shared slots are 1&2, 3&4, 5&6.

Option	Product
A	MURAIPXI-E4SF, MURAIPXI-E4SHF, MURAIPXI-D2MF, MURAIPXI-D2MHF, MURAIPXI-E2MF, MURAIPXI-E2MHF, MURAIPXI-D4JF, MURAIPXI-D4JHF, MURAIPXI-E4JF, or MURAIPXI-E4JHF
B	D1450 or D1480

Motherboard layout

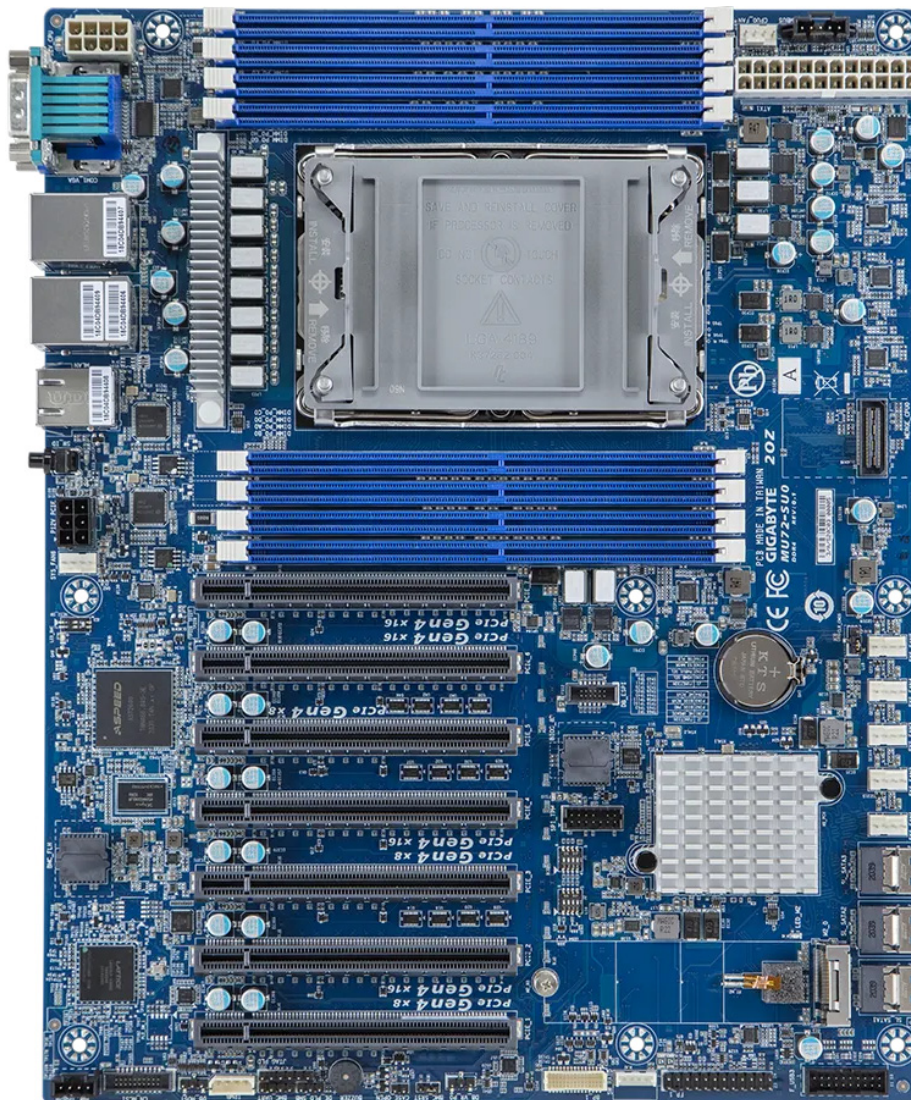

Gigabyte WRX80-SU8-IPMI (rev 1.0)

	D-Series based controllers	Third-party based controllers
Validated	Yes	No foreseeable compatibility issues

Maximum number of cards supported	7
Maximum supported Mura IPX Series	6
Maximum supported D-Series	4
Motherboard	Gigabyte WRX80-SU8-IPMI (rev. 1.0)
Chipset	AMD WRX80
Processor	AMD Ryzen Threadripper Pro 3955WX 3.9 GHz CPU
Heatsink (for CPU)	sWRX8 4094
System BIOS version	WRX80SU8-F4.08, 2021-10-27
System memory	64 GB DDR4 ECC RDIMM
Chassis	Chenbro RM41300-FS81 (includes fans)
Power supply	850 W (Part#: EVGA Supernova 850G3)
PCIe expansion slots	<ul style="list-style-type: none"> ▪ 6 PCIe x16 4.0 slots (x16 mechanical and electrical) ▪ 1 PCIe x16 4.0 slot (x16 mechanical and x8 electrical)
Notes	<ul style="list-style-type: none"> ▪ The chassis must be ordered from Chenbro. Power supply isn't included with the chassis. ▪ Only the front chassis fan that comes with the Chenbro chassis must be changed to: <ul style="list-style-type: none"> ▪ 120 mm x 120 mm x 25 mm 113 CFM (D1400 controller) ▪ The chassis fans must run at full speed. ▪ The dust protection filter in the front door must be removed for proper system ventilation. ▪ Ensure to have the following VGA settings in the system BIOS: Go to Advanced → Legacy Video Select → On Board/External VGA → and select Onboard. ▪ On-board console support with D-Series controller. Requires 3.05 or later drivers. ▪ Ensure to have the following default settings for Above 4G Decoding. In the system BIOS, go to Advanced → PCI Subsystem Settings → Above 4G Decoding → and select Enabled. ▪ There are eight memory channels. Ensure to have at least one DIMM populated per memory channel for optimized performance.

Configurations

Slot	D-Series based controller		Third-party based controller	
	Main	Options	Main	Options
Slot1	MURAIPIXI-E4JHF	A	MURAIPIXI-E4JHF	A
Slot2	MURAIPIXI-E4JHF	A	MURAIPIXI-E4JHF	A
Slot3	D1480	B	Third-party graphics hardware	-
Slot4	D1480	A, B	Third-party graphics hardware	A
Slot5	MURAIPIXI-E4JHF	A	MURAIPIXI-E4JHF	A
Slot6	D1480	A, B	Third-party graphics hardware	A
Slot7	D1480	A, B	Third-party graphics hardware	A

Performance considerations with D-Series controller

Slot	Connectivity	Configuration 1	Configuration 2	Configuration 3	Configuration 4
Slot1	x16	A	A	A	A
Slot2	x8	A	A	A	A
Slot3	x16	B	B	B	B
Slot4	x16	A	A	B	B
Slot5	x16	A	B	A	A
Slot6	x16	A	A	A	B
Slot7	x16	A	A	B	B

Option	Product
A	MURAIPIXI-E4SF, MURAIPIXI-E4SHF, MURAIPIXI-D2MF, MURAIPIXI-D2MHF, MURAIPIXI-E2MF, MURAIPIXI-E2MHF, MURAIPIXI-D4JF, MURAIPIXI-D4JHF, MURAIPIXI-E4JF, or MURAIPIXI-E4JHF
B	D1450 or D1480

Motherboard layout

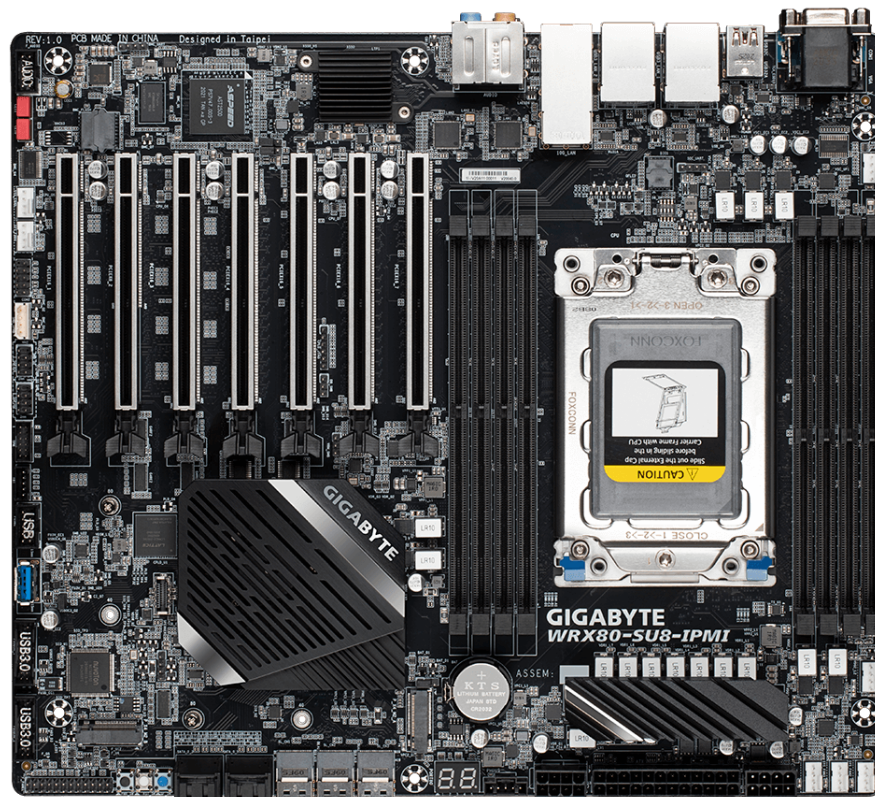

MSI TRX40 PRO 10G

	D-Series based controllers	Third-party based controllers
Validated	Yes	No foreseeable compatibility issues
Maximum number of cards supported	4	
Maximum supported Mura IPX Series	3	
Maximum supported D-Series	4	
Motherboard	MSI TRX40 PRO 10G	
Chipset	AMD TRX40	
Processor	AMD Ryzen™ Threadripper™ Pro 3960X @ 3.8 GHz	
Heatsink (for CPU)	sTRX4	
System BIOS version	1.81, 9/29/2021	
System memory	32 GB DDR4	
Chassis	Chenbro RM41300 FS81	
Power supply	750 W (Part#: EVGA SuperNOVA 750 G3)	
PCIe expansion slots	<ul style="list-style-type: none"> 4 PCIe x16 4.0 slots 	
Notes	<ul style="list-style-type: none"> The chassis must be ordered from Chenbro. Power supply isn't included with the chassis. The chassis fans must run at full speed. To set or change the fan speed, in the system BIOS, go to Settings → Hardware Monitor → and select All full Speed (f). In the system BIOS, go to Settings → Advanced → PCI Subsystem Settings → Above 4G and select Enabled. 	

Configurations

Slot	D-Series based controller		Third-party based controller	
	Main	Options	Main	Options
PCI_E1: PCIe 4.0 x16	D1480	B	Third-party graphics hardware	-
PCI_E2: PCIe 4.0 x8	MURAI PXI-E4JHF	A, B	MURAI PXI-E4JHF	A
PCI_E3: PCIe 4.0 x16	D1480	A, B	Third-party graphics hardware	A
PCI_E4: PCIe 4.0 x1	N/A		N/A	
PCI_E5: PCIe 4.0 x8	MURAI PXI-E4JHF	A, B, C	MURAI PXI-E4JHF	A

Performance considerations with D-Series controller

Slot	Connectivity	Configuration 1	Configuration 2
PCI_E1: PCIe 4.0 x16	x16	B*	B*
PCI_E2: PCIe 4.0 x8*	x8	A	N/A
PCI_E3: PCIe 4.0 x16	x16	N/A	B
PCI_E4: PCIe 4.0 x1	x1	A	N/A
PCI_E5: PCIe 4.0 x8	x8	A	A

Option	Product
A	MURAIPXI-E4SF, MURAIPXI-E4SHF, MURAIPXI-D2MF, MURAIPXI-D2MHF, MURAIPXI-E2MF, MURAIPXI-E2MHF, MURAIPXI-D4JF, MURAIPXI-D4JHF, MURAIPXI-E4JF, or MURAIPXI-E4JHF
B	D1450 or D1480
C	Matrox M9148 LP PCIe x16, Matrox M9140 LP PCIe x16, Matrox M9138 LP PCIe x16, Matrox M9128 LP PCIe x16, Matrox M9120 Plus LP PCIe x16, Matrox M9120 Plus LP PCIe x1, Matrox M9120 PCIe x16, NVIDIA Quadro P620, NVIDIA Quadro P600, NVIDIA Quadro P400, NVIDIA Quadro K620, AMD Radeon WX2100, or AMD Radeon Vega 8 (add-in card console options)

Motherboard layout



Supermicro C9Z390-PGW

	D-Series based controllers	Third-party based controllers
Validated	Yes	No foreseeable compatibility issues

Maximum number of cards supported	4
Maximum supported Mura IPX Series	3
Maximum supported D-Series	4
Motherboard	Supermicro C9Z390-PGW
Chipset	Intel Z390
Processor	Intel® Core™ i7-9700K CPU @ 3.60 GHz, 3600 MHz, 8 Core(s)
Heatsink (for CPU)	LGA 1151
System BIOS version	1.0A, 2018-04-21
System memory	32 GB DDR4
Chassis	Supermicro CSE-842XTQ
Power supply	600 W redundant power supply
PCIe expansion slots	<ul style="list-style-type: none"> 4 PCIe x16 3.0 slots (x16 mechanical, x16 / x8 electrical)
Notes	<ul style="list-style-type: none"> The chassis fans must run at full speed. To change the fan speed, go to the system BIOS main page → H/W Monitor → Fan Control Setting → and select Full Speed. In the system BIOS main page, go to Advanced → Graphics Configuration → and set: <ul style="list-style-type: none"> Primary Display to IGFX Internal Graphics to Enabled In the system BIOS main page, go to Advanced → PCIe/PCI/PnP Configuration → Option ROM execution → and set Above 4G MMIO BIOS Assignment to Enabled. On-board console support with D-Series controllers. Requires 3.05 drivers or later.

Configurations

Slot	D-Series based controller		Third-party based controller	
	Main	Options	Main	Options
CPU SLOT1 PCI-E 3.0 X8 (IN X16)	D1480	B	Third-party graphics hardware	-
CPU SLOT3 PCI-E 3.0 X 16	MURAI PXI-E4JF	A, B	MURAI PXI-D4JF	A
PCH SLOT4 PCI-E 3.0x1	N/A		N/A	
CPU SLOT5 PCI-E 3.0 X8 (IN X16)	D1480	A, B	Third-party graphics hardware	A
CPU SLOT7 PCI-E 3.0 X 16	MURAI PXI-E4JF	A, B	MURAI PXI-D4JF	A

Performance considerations with D-Series controller

Slot	Connectivity	Configuration 1	Configuration 2
CPU SLOT1 PCI-E 3.0 X8 (IN X16)	x16 / x8	B*	B*
CPU SLOT3 PCI-E 3.0 X 16	x8 / x0	A	A
PCH SLOT4 PCI-E 3.0x1	x1	N/A	N/A
CPU SLOT5 PCI-E 3.0 X8 (IN X16)	x16 / x8	A	B*
CPU SLOT7 PCI-E 3.0 X 16	x8 / x0	A	A

Note: * The GPU bandwidth is reduced to 6 GB/s instead of 12 GB/s when shared slots are used. Shared slots are 1 & 3 and 5 & 7.

Option	Product
A	MURAIPIXI-E4SF, MURAIPIXI-E4SHF, MURAIPIXI-D2MF, MURAIPIXI-D2MHF, MURAIPIXI-E2MF, MURAIPIXI-E2MHF, MURAIPIXI-D4JF, MURAIPIXI-D4JHF, MURAIPIXI-E4JF, or MURAIPIXI-E4JHF
B	D1450 or D1480

Motherboard layout



Supermicro C9Z490-PG

	D-Series based controllers	Third-party based controllers
Validated	Yes	No foreseeable compatibility issues

Maximum number of cards supported	4
Maximum supported Mura IPX Series	3
Maximum supported D-Series	4
Motherboard	Supermicro C9Z490-PG
Chipset	Intel Z490
Processor	Intel® Core™ i7-10700 CPU @ 2.90 GHz
Heatsink (for CPU)	LGA 1200
System BIOS version	1.0A, 2020-04-16
System memory	32 GB DDR4
Chassis	Supermicro CSE-842XTQ-R606B
Power supply	600 W redundant power supply
PCIe expansion slots	<ul style="list-style-type: none"> 4 PCIe x16 3.0 slots (x16 mechanical, x16 / x8 electrical)
Notes	<ul style="list-style-type: none"> The chassis fans must run at full speed. To change the fan speed, go to the system BIOS main page → H/W Monitor → Fan Control Setting → and select Full Speed. In the system BIOS main page, go to Advanced → Graphics Configuration → and set: <ul style="list-style-type: none"> Primary Display to AUTO Internal Graphics to AUTO In the system BIOS main page, go to Advanced → PCIe/PCI/PnP Configuration → Option ROM execution → and set Above 4G MMIO BIOS Assignment to Enabled.

Configurations

Slot	D-Series based controller		Third-party based controller	
	Main	Options	Main	Options
CPU SLOT1 PCI-E 3.0 X8 (IN X16)	D1480	B	Third-party graphics hardware	-
CPU SLOT3 PCI-E 3.0 X 16	MURAIPIXI-E4JF	A, B	MURAIPIXI-E4JF	A
PCH SLOT4PCI-E 3.0x1	N/A		N/A	
CPU SLOT5 PCI-E 3.0 X8 (IN X16)	D1480	A, B	Third-party graphics hardware	A
CPU SLOT7 PCI-E 3.0 X 16	MURAIPIXI-E4JF	A, B	MURAIPIXI-E4JF	A

Performance considerations with D-Series controller

Slot	Connectivity	Configuration 1	Configuration 2
CPU SLOT1 PCI-E 3.0 X8 (IN X16)	x16 / x8	B*	B*
CPU SLOT3 PCI-E 3.0 X 16	x8 / x0	A	A
CPU SLOT5 PCI-E 3.0 X8 (IN X16)	x16 / x8	A	B*
CPU SLOT7 PCI-E 3.0 X 16	x8 / x0	A	A

Note: * The GPU bandwidth is reduced to 6 GB/s instead of 12 GB/s when shared slots are used. Shared slots are 1 & 3 and 5 & 7.

Option	Product
A	MURAIPIXI-E4SF, MURAIPIXI-E4SHF, MURAIPIXI-D2MF, MURAIPIXI-D2MHF, MURAIPIXI-E2MF, MURAIPIXI-E2MHF, MURAIPIXI-D4JF, MURAIPIXI-D4JHF, MURAIPIXI-E4JF, or MURAIPIXI-E4JHF
B	D1450 or D1480

Motherboard layout

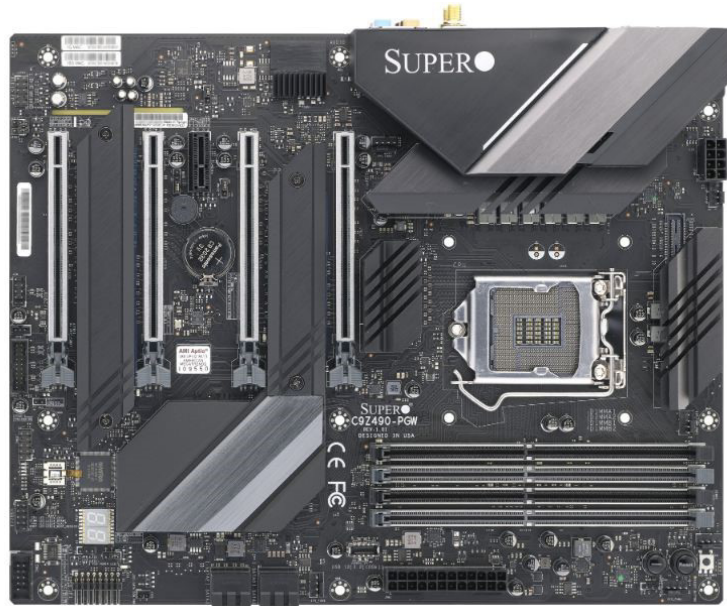

Supermicro H11SSL-i

	D-Series based controllers	Third-party based controllers
Validated	Yes	No foreseeable compatibility issues

Maximum number of cards supported	4
Maximum supported Mura IPX Series	3
Maximum supported D-Series	3
Motherboard	Supermicro H11SSL-i
Chipset	AMD SP3
Processor	AMD EPYC 7251 8-Core Processor, 2100 MHz
Heatsink (for CPU)	SOCKET SP3 (Supermicro part#: SNK-P0064AP4)
System BIOS version	1.3, 2019-06-25
System memory	32 GB DDR4
Chassis	Supermicro CSE-842XTQ
Power supply	600 W redundant power supply
PCIe expansion slots	<ul style="list-style-type: none"> ▪ 3 PCIe x16 3.0 slots ▪ 3 PCIe x8 3.0 slots
Notes	<ul style="list-style-type: none"> ▪ In the system BIOS main page, go to Advanced → PCIe/PCI/PnP Configuration → and set Above 4G Decoding to Enabled. ▪ In the system BIOS main page, go to Advanced → PCIe/PCI/PnP Configuration → M.2 PCIe4 OPROM → and set to Disabled. ▪ In the system BIOS main page, go to Advanced → PCIe/PCI/PnP Configuration → and set VGA Priority to Offboard. ▪ In the system BIOS main page, go to IPMI Tab → IPMI Function Support → and set to Enabled. ▪ Requires installation of Supermicro SuperDoctor® 5 to control the fan speed. Ensure to have the fan speed set to full speed. ▪ Requires a low profile CPU cooler for the CPU heatsink that can be purchased from Supermicro (Part#: SNK-P0064AP4). ▪ Slots 3 and 5 are unusable due to mechanical conflict. The heatsink on the motherboard conflicts with the PCIe16 add-in card gold fingers. ▪ On-board console support with D-Series controllers. Requires 3.05 drivers or later.

Configurations

Slot	D-Series based controller		Third-party based controller	
	Main	Options	Main	Options
CPU SLOT1 PCI-E 3.0 X8	MURAIPIXI-E4JHF	A	MURAIPIXI-E4JHF	A
CPU SLOT2 PCI-E 3.0 X16	MURAIPIXI-E4JHF	A, B	MURAIPIXI-E4JHF	A
CPU SLOT3 PCI-E 3.0 X8	N/A		N/A	
CPU SLOT4 PCI-E 3.0 X16	D1480	B	Third-party graphics hardware	A
CPU SLOT5 PCI-E 3.0 X8	N/A		N/A	
CPU SLOT6 PCI-E 3.0 X16	D1480	A, B	Third-party graphics hardware	-

Performance considerations with D-Series controller

Slot	Connectivity	Configuration 1	Configuration 2	Configuration 3
CPU SLOT1 PCI-E 3.0 X8	x8	A	A	A
CPU SLOT2 PCI-E 3.0 X16	x16	A	B	A
CPU SLOT3 PCI-E 3.0 X8	x8	N/A	N/A	N/A
CPU SLOT4 PCI-E 3.0 X16	x16	A	B	B
CPU SLOT5 PCI-E 3.0 X8	x8	N/A	N/A	N/A
CPU SLOT6 PCI-E 3.0 X16	x16	B	B	B

Note: Slots 3 and 5 are unusable due to mechanical conflict (MB heatsink interferes with PCIex16 card gold finger tabs).

Option	Product
A	MURAI PXI-E4SF, MURAI PXI-E4SHF, MURAI PXI-D2MF, MURAI PXI-D2MHF, MURAI PXI-E2MF, MURAI PXI-E2MHF, MURAI PXI-D4JF, MURAI PXI-D4JHF, MURAI PXI-E4JF, or MURAI PXI-E4JHF
B	D1450 or D1480

Motherboard layout

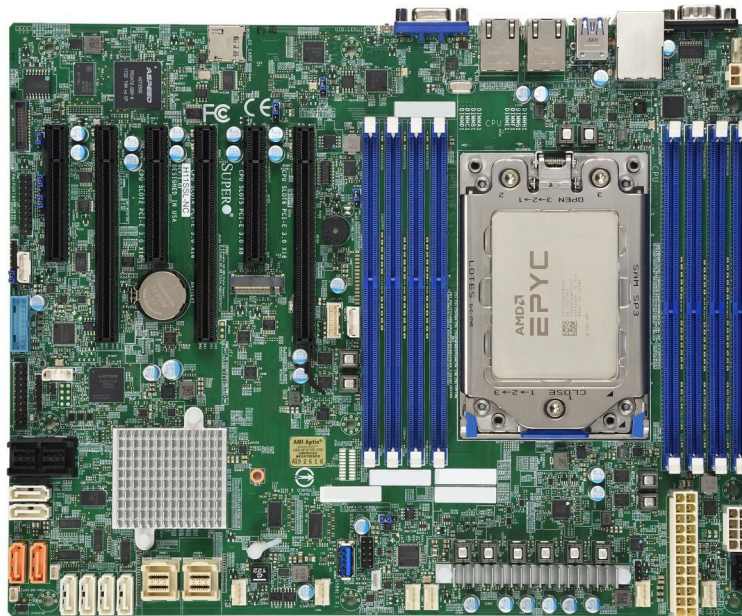

Supermicro X11SPA-TF/X11SPA-T

	D-Series based controllers	Third-party based controllers
Validated	Yes	No foreseeable compatibility issues
Maximum number of cards supported	7	
Maximum supported Mura IPX Series	6	
Maximum supported D-Series	4	
Motherboard	X11SPA-TF/X11SPA-T	
Chipset	Intel C621	
Processor	Intel® Xeon® Silver 4208 CPU @ 2.10 GHz	
Heatsink (for CPU)	LGA-3647 (Supermicro part#: SNK-P0071APS4)	
System BIOS version	3.8a, 2022-10-28	
System memory	32 GB	
Chassis	Supermicro CSE-747BTS-R2K20BP	
Power supply	2200 W redundant power supply	
PCIe expansion slots	<ul style="list-style-type: none"> 4 PCIe 3.0 x16 electrical & mechanical 3 PCIe 3.0 x8 electrical & x16 mechanical 	
Notes	<ul style="list-style-type: none"> The system fan must be set to HeavyIO mode in IPMI. Optional rack-mount kit mounting rails are available (Supermicro part#: MCP-290-00059-0B). 	

Configurations

Slot	D-Series based controller		Third-party based controller	
	Main	Options	Main	Options
CPU SLOT1 PCI-E 3.0 X16	D1480	B	Third-party graphics hardware	-
CPU SLOT2 PCI-E 3.0 X8	MURAIPIXI-D4JF	A	MURAIPIXI-D4JF	A
CPU SLOT3 PCI-E 3.0 X16	D1480	A, B	Third-party graphics hardware	A
CPU SLOT4 PCI-E 3.0 X8	MURAIPIXI-D4JF	A	MURAIPIXI-D4JF	A
CPU SLOT5 PCI-E 3.0 X16	D1480	A, B	Third-party graphics hardware	A
CPU SLOT6 PCI-E 3.0 X8	MURAIPIXI-D4JF	A	MURAIPIXI-D4JF	A
CPU SLOT7 PCI-E 3.0 X16	D1480	A, B	Third-party graphics hardware	A

Performance considerations with D-Series controller

Slot	Connectivity	Configuration 1	Configuration 2	Configuration 3	Configuration 4
CPU SLOT1 PCI-E 3.0 X16	x16	B	B	B	B
CPU SLOT2 PCI-E 3.0 X8	x0 / x8	A	A	A	A
CPU SLOT3 PCI-E 3.0 X16	x16 / x8	A	B*	B*	B*
CPU SLOT4 PCI-E 3.0 X8	x0 / x8	A	A	A	A
CPU SLOT5 PCI-E 3.0 X16	x16 / x8	A	A	B*	B*
CPU SLOT6 PCI-E 3.0 X8	x0 / x8	A	A	A	A
CPU SLOT7 PCI-E 3.0 X16	x16 / x8	A	A	A	B*

Note: * D-Series bandwidth is reduced to 6 GB/s instead of 12 GB/s when shared slot is used. However, the performance depends on the layout, the number of streams going to each D-Series. rendering done, and the intended usage. Shared slots are 2&3, 4&5, and 6&7.

Option	Product
A	MURAI PXI-E4SF, MURAI PXI-E4SHF, MURAI PXI-D2MF, MURAI PXI-D2MHF, MURAI PXI-E2MF, MURAI PXI-E2MHF, MURAI PXI-D4JF, MURAI PXI-D4JHF, MURAI PXI-E4JF, or MURAI PXI-E4JHF
B	D1450 or D1480

Motherboard layout

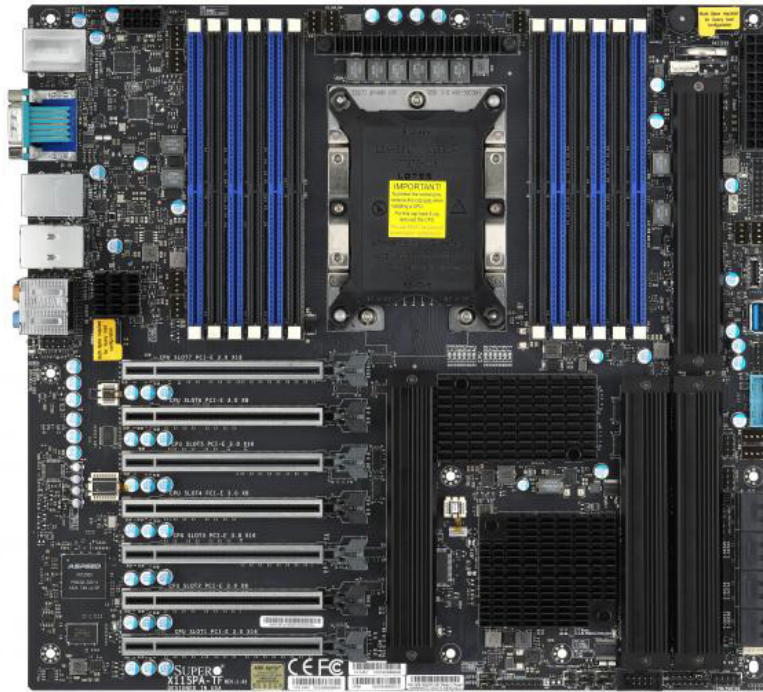

Supermicro X12SPA-TF

	D-Series based controllers	Third-party based controllers
Validated	Yes	No foreseeable compatibility issues

Maximum number of cards supported	7
Maximum supported Mura IPX Series	6
Maximum supported D-Series	4
Validated OS	Windows 10 Enterprise LTSC; Version 10.0.19044 Build 19044
Motherboard	X12SPA-TF
Chipset	Intel C621A
Processor	Intel® Xeon® W-3335 CPU @ 3.4 GHz
Heatsink (for CPU)	LGA-4189 (Part#: SNK-P00081AP4)
System BIOS version	1.1, 2021-06-21
System memory	64 GB (8 x 8 GB 3200 MHz ECC DDR4 RDIMM)
Chassis	CSE-747BTS-R2K20BP
Power supply	2 x 2200 W redundant power supply (Part#: PWS-2K20A-1R; included with the chassis)
PCIe expansion slots	<ul style="list-style-type: none"> ▪ 4 PCIe x16 4.0 slots ▪ 3 PCIe x8 4.0 slots (in x16 slots)
Notes	<ul style="list-style-type: none"> ▪ The system fan speed must be set to run at full speed in IPMI. ▪ Ensure to have the following settings for Onboard VGA in the system BIOS: <ul style="list-style-type: none"> ▪ Go to Advanced → PCIe/PCI/PnP Configuration → VGA Priority → select Onboard. ▪ Onboard console support with D-Series controller. Requires 3.05 or later drivers. ▪ Ensure to have the following settings for Above 4G Decoding in the system BIOS: <ul style="list-style-type: none"> ▪ Go to Advanced → PCIe/PCI/PnP Configuration → Above 4G Decoding → select Enabled. ▪ Slot1 shared with four M.2 slots. For Slot1 to perform at x16 electrical, disable the four M.2 slots. In the system BIOS: <ul style="list-style-type: none"> ▪ Go to Advanced → PCIe/PCI/PnP Configuration → M.2-CO1 PCI-e 4.0 x4 OPROM → select Disabled. ▪ Go to Advanced → PCIe/PCI/PnP Configuration → M.2-CO2 PCI-e 4.0 x4 OPROM → select Disabled. ▪ Go to Advanced → PCIe/PCI/PnP Configuration → M.2-CO3 PCI-e 4.0 x4 OPROM → select Disabled. ▪ Go to Advanced → PCIe/PCI/PnP Configuration → M.2-CO4 PCI-e 4.0 x4 OPROM → select Disabled. ▪ There are sixteen DIMM slots. Ensure to have at least one DIMM populated per memory channel for optimized performance. Follow the memory population sequence as outlined in the system manual. ▪ Optional rack-mount kit mounting rails are available (Supermicro part#: MCP-290-00059-0B).

Configurations

Slot	D-Series based controller		Third-party based controller	
	Main	Options	Main	Options
CPU SLOT1 PCI-E 4.0 X16	D1480	B	Third-party graphics hardware	-
CPU SLOT2 PCI-E 4.0 X8 (INx16)	MURAIPIXI-E4JHF	A	MURAIPIXI-E4JHF	A
CPU SLOT3 PCI-E 4.0 X16	D1480	A, B	Third-party graphics hardware	A
CPU SLOT4 PCI-E 4.0 X8 (INx16)	MURAIPIXI-E4JHF	A	MURAIPIXI-E4JHF	A
CPU SLOT5 PCI-E 4.0 X16	D1480	A, B	Third-party graphics hardware	A
CPU SLOT6 PCI-E 4.0 X8 (INx16)	MURAIPIXI-E4JHF	A	MURAIPIXI-E4JHF	A
CPU SLOT7 PCI-E 4.0 X16	D1480	A, B	Third-party graphics hardware	A

Performance considerations with D-Series controller

Slot	Connectivity	Configuration 1	Configuration 2	Configuration 3	Configuration 4
CPU SLOT1 PCI-E 4.0 X16	x16 / x8*	B	B	B	B
CPU SLOT2 PCI-E 4.0 X8 (INx16)	x8 / x0	A	A	A	A
CPU SLOT3 PCI-E 4.0 X16	x16 / x8	A	B	B	B
CPU SLOT4 PCI-E 4.0 X8 (INx16)	x8 / x0	A	A	A	A
CPU SLOT5 PCI-E 4.0 X16	x16 / x8	A	A	B	B
CPU SLOT6 PCI-E 4.0 X8 (INx16)	x8 / x0	A	A	A	A
CPU SLOT7 PCI-E 4.0 X16)	x16 / x8	A	A	A	B

Note: Shared slots are 2&3, 4&5, and 6&7.

*Slot1 is shared with M.2 slots. For Slot1 to perform at x16 electrical, disable the four M.2 slots in the system BIOS.

Option	Product
A	MURAIPIXI-E4SF, MURAIPIXI-E4SHF, MURAIPIXI-D2MF, MURAIPIXI-D2MHF, MURAIPIXI-E2MF, MURAIPIXI-E2MHF, MURAIPIXI-D4JF, MURAIPIXI-D4JHF, MURAIPIXI-E4JF, or MURAIPIXI-E4JHF
B	D1450 or D1480

Motherboard layout

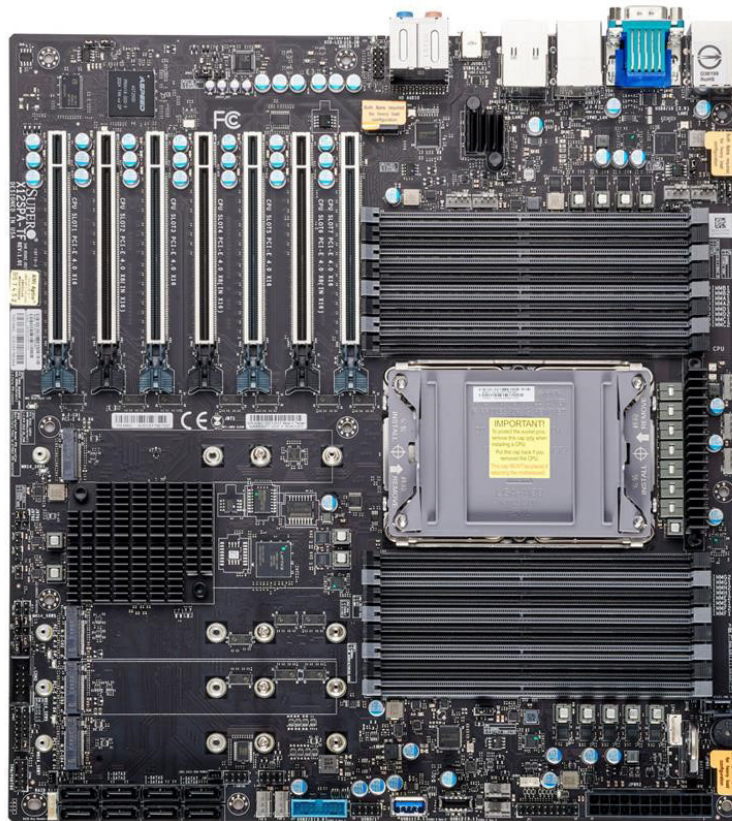

Supermicro X13SWA-TF

	D-Series based controllers	Third-party based controllers
Validated	Yes	No foreseeable compatibility issues

Maximum number of cards supported	6
Maximum supported Mura IPX Series	5
Maximum supported D-Series	4
Validated OS	Windows 10 Enterprise LTSC; Version 10.0.19044 Build 19044
Motherboard	Supermicro X13SWA-TF
Chipset	Intel W790
Processor	Intel® Xeon® W5-3423 CPU @ 2.1 GHz
Heatsink (for CPU)	LGA 4677 (Part#: SNK-P0091AP4)
System BIOS version	1.1, 2023-02-15
System memory	128 GB (8 x16 GB 4800 MHz ECC DDR5 RDIMM)
Chassis	Supermicro CSE-747BTS-R2K20BP
Power supply	2 x 2200 W Redundant PSU (Part#: PWS-2K20A-1R; included with the chassis)
PCIe expansion slots	<ul style="list-style-type: none"> 6 PCIe x16 5.0 slots
Notes	<ul style="list-style-type: none"> The chassis fans speed must be set to Heavy I/O mode in IPMI. In the system BIOS, go to Advanced → PCIe/PCI/PnP Configuration → VGA Priority → select Offboard. Ensure to have the following settings for Above 4G Decoding in the system BIOS: <ul style="list-style-type: none"> Go to Advanced → PCIe/PCI/PnP Configuration → Above 4G Decoding → select Enabled. On-board console support with D-Series controller. Requires 3.05 or later drivers. Optional rack-mount kit mounting rails are available (Supermicro part#: MCP-290-00059-0B).

Configurations

Slot	D-Series based controller		Third-party based controller	
	Main	Options	Main	Options
CPU SLOT1 PCIe 5.0 X16	D1480	A, B	Third-party graphics hardware	A
SLOT2 (no connector)	-	-	-	-
CPU SLOT3 PCIe 5.0 X16	D1480	A, B	Third-party graphics hardware	A
CPU SLOT4 PCIe 5.0 X16	MURAI PXI-E4JHF	A	MURAI PXI-E4JHF	A
CPU SLOT5 PCIe 5.0 X16	D1480	A, B	Third-party graphics hardware	A
CPU SLOT6 PCIe 5.0 X16	MURAI PXI-E4JHF	A	MURAI PXI-E4JHF	A
CPU SLOT7 PCIe 5.0 X16	D1480	B	Third-party graphics hardware	-

Performance considerations with D-Series controller

Slot	Connectivity	Configuration 1	Configuration 2	Configuration 3	Configuration 4
CPU SLOT1 PCIe 5.0 X16	x16	A	A	A	B
SLOT2	No connector	-	-	-	-
CPU SLOT3 PCIe 5.0 X16	x16	A	A	B	B
CPU SLOT4 PCIe 5.0 X16	x16	A	A	A	A
CPU SLOT5 PCIe 5.0 X16	x16	A	B	B	B
CPU SLOT6 PCIe 5.0 X16	x16	A	A	A	A
CPU SLOT7 PCIe 5.0 X16	x16	B	B	B	B

Option	Product
A	MURAI PXI-E4SF, MURAI PXI-E4SHF, MURAI PXI-D2MF, MURAI PXI-D2MHF, MURAI PXI-E2MF, MURAI PXI-E2MHF, MURAI PXI-D4JF, MURAI PXI-D4JHF, MURAI PXI-E4JF, or MURAI PXI-E4JHF
B	D1450 or D1480

Motherboard layout

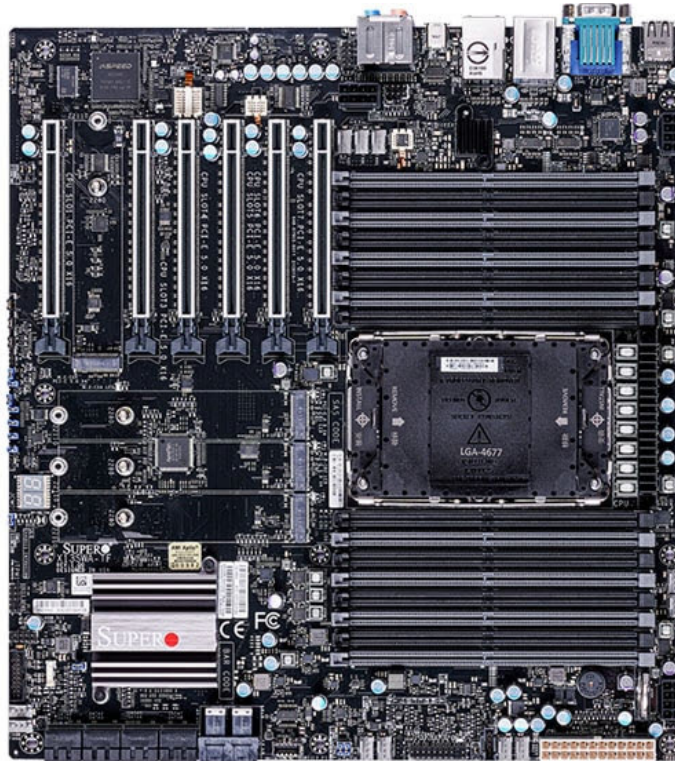

EOL (End of Life) motherboards

ASUS Pro WS C621 64L SAGE 10G

	D-Series based controllers	Third-party based controllers
Validated	Yes	No foreseeable compatibility issues

Maximum number of cards supported	4
Maximum supported Mura IPX Series	3
Maximum supported D-Series	4
Motherboard	ASUS PRO WS C621-64L SAGE/10G
Chipset	Intel C621
Processor	Intel® Xeon® W-3223 CPU @ 3.50 GHz 64-lane CPU
Heatsink (for CPU)	LGA 3647
System BIOS version	1001, 2020-02-19
System memory	32 GB DDR4 ECC-RDIMM
Chassis	Chenbro RM41300 FS81
Power supply	750 W (Part#: EVGA SuperNOVA 750 G3)
PCIe expansion slots	With 64-lane CPU <ul style="list-style-type: none"> ▪ 4 PCIe x16 3.0 slots (x16 mechanical and electrical) ▪ 1 PCIe x8 3.0 slot With 48-lane CPU <ul style="list-style-type: none"> ▪ 2 PCIe x16 3.0 slots (x16 mechanical and electrical) ▪ 2 PCIe x16 3.0 slots (x16 mechanical and x8 electrical) ▪ 1 PCIe x4 3.0 slot
Notes	<ul style="list-style-type: none"> ▪ Requires a low profile CPU cooler. ▪ Refer to the memory AVL list provided by ASUS to use with this motherboard. ▪ The chassis must be ordered from Chenbro. Power supply isn't included with the chassis. ▪ The chassis fans must run at full speed. To change the fan speed, go to the system BIOS main page → Monitor → select the header to which the chassis fans are connected → change from Generic to Full Speed and apply the changes. ▪ In the system BIOS main page, go to Advanced → Boot, then set Above 4G Decoding to ON and First VGA 4G Decode to Auto.

Configurations

Slot	D-Series based controller		Third-party based controller	
	Main	Options	Main	Options
PCIEX16_1	D1480	B	Third-party graphics hardware	-
PCIEX16_2	D1480	A, B	Third-party graphics hardware	A
PCIEX4_1	N/A		N/A	
PCIEX16_3	MURAI PXI-E4JF	A, B	MURAI PXI-E4JF	A
PCIEX16_4	MURAI PXI-E4JF	A, B	MURAI PXI-E4JF	A

Performance considerations with D-Series controller

Slot	Connectivity (48-lane CPU)	Connectivity (64-lane CPU)	Configuration 1	Configuration 2	Configuration 3	Configuration 4*
PCIEX16_1	x16	x16	B	B	B	B
PCIEX16_2	x16 / x8	x16	A	A	B	B
PCIEX4_1	N/A	N/A	N/A	N/A	N/A	N/A
PCIEX16_3	x16	x16	A	B	B	B
PCIEX16_4	x8 / x0	x16	A	A	A*	B

Note: * Requires 64-lane CPU.

Option	Product
A	MURAI PXI-E4SF, MURAI PXI-E4SHF, MURAI PXI-D2MF, MURAI PXI-D2MHF, MURAI PXI-E2MF, MURAI PXI-E2MHF, MURAI PXI-D4JF, MURAI PXI-D4JHF, MURAI PXI-E4JF, or MURAI PXI-E4JHF
B	D1450 or D1480

Motherboard layout



ASUS WS Z390 Pro

	D-Series based controllers	Third-party based controllers
Validated	Yes	No foreseeable compatibility issues
Maximum number of cards supported	4	
Maximum supported Mura IPX Series	3	
Maximum supported D-Series	4	
Motherboard	ASUS WS Z390 Pro	
Chipset	Intel Z390	
Processor	Intel® Core™ I5-9600K CPU @ 3.70 GHz Intel® Core™ I9-9900K CPU @ 3.60 GHz	
Heatsink (for CPU)	LGA 1151	
System BIOS version	0701, 2019-05-24	
System memory	32 GB DDR4	
Chassis	Chenbro RM41300-FS81	
Power supply	850 W (Part#: EVGA Supernova 850G3)	
PCIe expansion slots	<ul style="list-style-type: none"> ▪ 4 PCIe x16 3.0 slots (x16 mechanical, x16 / x8 electrical) ▪ 1 PCIe x4 3.0 slot 	
Notes	<ul style="list-style-type: none"> ▪ The chassis must be ordered from Chenbro. Power supply isn't included with the chassis. ▪ The chassis fans must run at full speed. To change the fan speed, go to the system BIOS main page (EZ mode) → select QFan Control → select the header to which the fans are connected → change from Standard to Full Speed and apply the changes. ▪ Make sure you have the following settings for Above 4G Decoding. In the system BIOS main page, go to Advanced → Boot, then set Above 4G Decoding to ON and First VGA 4G Decode to Above_4G. 	

Configurations

Slot	D-Series based controller		Third-party based controller	
	Main	Options	Main	Options
PCIEX16_1	D1480	B	Third-party graphics hardware	-
PCIEX16_2	MURAI PXI-E4JHF	A, B	MURAI PXI-E4JHF	A
PCIEX4_1	N/A		N/A	
PCIEX16_3	D1480	A, B	Third-party graphics hardware	A
PCIEX16_4	MURAI PXI-E4JHF	A, B	MURAI PXI-E4JHF	A

Performance considerations with D-Series controller

Slot	Connectivity	Configuration 1	Configuration 2
PCIEX16_1	x16 / x8	B*	B*
PCIEX16_2	x8 / x0	A	A
PCIEX4_1	x4	N/A	N/A
PCIEX16_3	x16 / x8	A	B*
PCIEX16_4	x8 / x0	A	A

Note: * The GPU PCIe bandwidth is reduced to 6 GB/s instead of 12 GB/s when shared slots are used. Shared slots are 1 & 2 and 3 & 4.

Option	Product
A	MURAI PXI-E4SF, MURAI PXI-E4SHF, MURAI PXI-D2MF, MURAI PXI-D2MHF, MURAI PXI-E2MF, MURAI PXI-E2MHF, MURAI PXI-D4JF, MURAI PXI-D4JHF, MURAI PXI-E4JF, or MURAI PXI-E4JHF
B	D1450 or D1480

Motherboard layout



Portwell M9010A (with ROBO-8113VG2AR SHB)

	D-Series based controllers	Third-party based controllers
Validated	Yes	No foreseeable compatibility issues

Maximum number of cards supported	10
Maximum supported Mura IPX Series	9
Maximum supported D-Series	4
Motherboard	Portwell PBPE-11A-MT (Backplane) Portwell ROBO-8113VG2AR (SHB)
Chipset	Intel C246
Processor	Intel® Core™ i3-6100 CPU @ 3.70 GHz, 3700 MHz
Heatsink (for CPU)	LGA 1151
System BIOS version	R1.00.E0, 2019-12-16
System memory	32 GB DDR4
Chassis	Industrial 4U rack mount (not included – Portwell part#: 21-M90104-0012)
Power supply	950 W redundant PSU (not included – Portwell part#: 02-527050-0002)
PCIe expansion slots	<ul style="list-style-type: none"> 10 PCIe x16 2.0 slots (x16 mechanical and electrical)
Notes	<ul style="list-style-type: none"> In the system BIOS, go to Advanced → Graphics Configuration → Internal Graphics → and select Disabled. In the system BIOS, go to Advanced → Chipset Configuration → Above 4G MMIO BIOS Assignment → select Enabled. In the system BIOS, go to Advanced → Chipset Configuration → Above 4G Decoding → and select Enabled. The system BIOS is available at ftp://portwell_bios:xQGnkWnQ@privftp.matrox.com. Portwell system BIOS files with “-MT” are custom BIOS versions specific to Matrox configurations.

Configurations

Slot	D-Series based controller		Third-party based controller	
	Main	Option	Main	Option
J1	D1480	B	Third-party graphics hardware	-
J2	MURAIPIXI-E4JHF	A	MURAIPIXI-E4JHF	A
J3	D1480	A, B	Third-party graphics hardware	A
J4	MURAIPIXI-E4JHF	A	MURAIPIXI-E4JHF	A
J5	MURAIPIXI-E4JHF	A	MURAIPIXI-E4JHF	A
J6	D1480	A, B	Third-party graphics hardware	A
J7	MURAIPIXI-E4JHF	A	MURAIPIXI-E4JHF	A
J8	D1480	A, B	Third-party graphics hardware	A
J9	MURAIPIXI-E4JHF	A	MURAIPIXI-E4JHF	A
J10	MURAIPIXI-E4JHF	A	MURAIPIXI-E4JHF	A

Performance considerations with D-Series controller

Slot	Connectivity	Configuration 1	Configuration 2	Configuration 3	Configuration 4
J1	x16	B	B	B	B
J2	x16	A	A	A	A
J3	x16	A	A	B	B
J4	x16	A	A	A	A
J5	x16	A	A	A	A
J6	x16	A	B	B	B
J7	x16	A	A	A	A
J8	x16	A	A	A	B
J9	x16	A	A	A	A
J10	x16	A	A	A	A

Note: The backplane has a single PCIe x16 Gen2 connection to the CPU. Therefore, the maximum stream bandwidth is limited to 6 GB/s in the best case scenario.

Option	Product
A	MURAIPIXI-E4SF, MURAIPIXI-E4SHF, MURAIPIXI-D2MF, MURAIPIXI-D2MHF, MURAIPIXI-E2MF, MURAIPIXI-E2MHF, MURAIPIXI-D4JF, MURAIPIXI-D4JHF, MURAIPIXI-E4JF, or MURAIPIXI-E4JHF
B	D1450 or D1480

Backplane layout

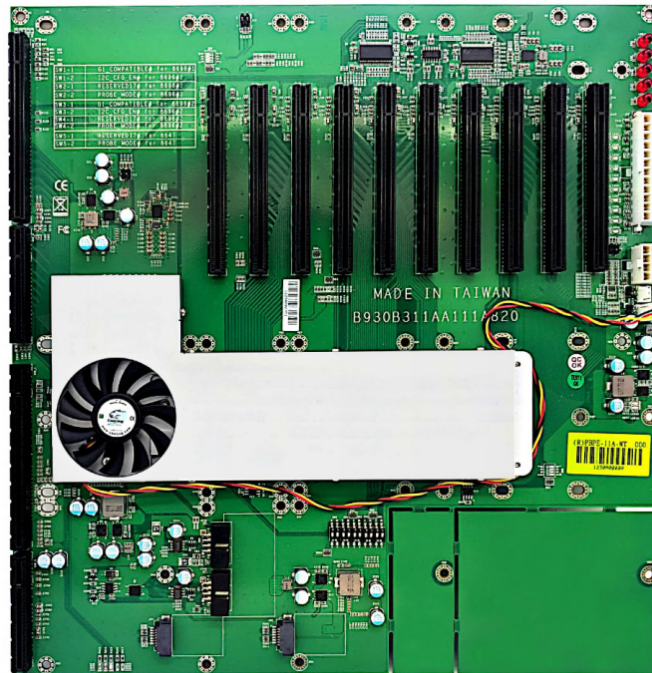

Validated PCIe expansion boxes

The following PCIe expansion boxes have been validated by Matrox to work with Matrox Mura IPX Series and Matrox D-Series products.



Note: For improved performance, we recommend you avoid using PCIe® x4 slots or lower.

Currently supported PCIe expansion box

OSS 4U Value 8-Slot Expansion System

Maximum number of cards supported	8
Part number	OSS-PCIe3-4UV-8-1
Backplane	OSS-PCIe-BP-452
Host / Target Adapters	PCIe x16 Gen3 iPass Cable Adapters. Part#: <ul style="list-style-type: none"> ▪ OSS-PCIe-HIB38-x16-T-H ▪ OSS-PCIe-HIB38-x16-H-H
Chassis	4U rack mount
Power supply	Two x 2000 W load-sharing power supplies
Available PCIe expansion slots	<ul style="list-style-type: none"> ▪ 1 PCIe x16 3.0 Host interface card slot ▪ 8 PCIe x8 3.0 Expansion slots
Notes	<ul style="list-style-type: none"> ▪ Insert the Host adapter (Part#: OSS-PCIe-HIB38-x16-H-H) in the D-Series / Third-party controller Host system. ▪ Insert the Target adapter (Part#: OSS-PCIe-HIB38-x16-T-H) in the PCIe x16 slot of the Expansion system. ▪ Connect the Target and Host adapter iPass connectors via x16 iPass cable. ▪ While using ECA EVS-XL as D-Series controller host system, insert the Host adapter in EVS-XL slot P2PCIE2.

Expansion configurations

Slot	D-Series based controller		Third-party based controller	
	Main	Options	Main	Options
PCIEX16_HOST INTERFACE CARD SLOT	OSS-PCIe-HIB38-x16-T-H	N/A	OSS-PCIe-HIB38-x16-T-H	N/A
PCIEX8_CARD SLOT1	MURAIPIXI-E4JF	A	MURAIPIXI-E4JF	A
PCIEX8_CARD SLOT2	MURAIPIXI-E4JF	A	MURAIPIXI-E4JF	A
PCIEX8_CARD SLOT3	MURAIPIXI-E4JF	A	MURAIPIXI-E4JF	A
PCIEX8_CARD SLOT4	MURAIPIXI-E4JF	A	MURAIPIXI-E4JF	A
PCIEX8_CARD SLOT5	MURAIPIXI-E4JF	A	MURAIPIXI-E4JF	A
PCIEX8_CARD SLOT6	MURAIPIXI-E4JF	A	MURAIPIXI-E4JF	A
PCIEX8_CARD SLOT7	MURAIPIXI-E4JF	A	MURAIPIXI-E4JF	A
PCIEX8_CARD SLOT8	MURAIPIXI-E4JF	A	MURAIPIXI-E4JF	A

Performance considerations with D-Series controller

Slot	Connectivity	Configuration 1
PCIEX8_CARD SLOT1	x8	A
PCIEX8_CARD SLOT2	x8	A
PCIEX8_CARD SLOT3	x8	A
PCIEX8_CARD SLOT4	x8	A
PCIEX8_CARD SLOT5	x8	A
PCIEX8_CARD SLOT6	x8	A
PCIEX8_CARD SLOT7	x8	A
PCIEX8_CARD SLOT8	x8	A

Note: The maximum stream performance is 12 GB/s.

Option	Product
A	MURAI PXI-E4SF, MURAI PXI-E4SHF, MURAI PXI-D2MF, MURAI PXI-D2MHF, MURAI PXI-E2MF, MURAI PXI-E2MHF, MURAI PXI-D4JF, MURAI PXI-D4JHF, MURAI PXI-E4JF, or MURAI PXI-E4JHF
B	D1450 or D1480

Validated chassis

The following chassis have been validated by Matrox to work with Matrox Mura IPX Series, Matrox D1480, and Matrox D1450 products.



Note: For improved performance, we recommend you avoid using PCIe® x4 slots or lower.

Currently supported chassis

Advantech ACP-4000

Cards supported (maximum)	5
Part number	ACP-4000MB-00XE / ACP-4000MB-00F (includes chassis and standard 82 CFM chassis fans)
Power supply	Advantech FSP700-80PSA (Part#: 96PS-A700WPS2)
Power supply bracket	Standard
Fan	Two 120 mm x 120 mm x 25 mm 150 CFM standard cooling fans (must upgrade from 82 CFM standard fans to 120 CFM or 150 CFM fans)
Supported motherboards	Advantech ASMB-815
Notes	<ul style="list-style-type: none">▪ Power supply is not included with the chassis. It must be purchased separately.▪ The standard chassis fans must be replaced with two 120mm x 120mm x 25mm 120 CFM or 150 CFM chassis fans.▪ The dust protection sponge filter in front of the chassis must be removed for proper system ventilation.▪ The chassis fans must run at full speed.▪ With 120 CFM fans:<ul style="list-style-type: none">▪ D1400 controller: The ambient temperature must not exceed 40 degrees centigrade.▪ With 150 CFM fans:<ul style="list-style-type: none">▪ Wired mesh filter can be used in front of the chassis with 150 CFM fans only.▪ Filter requires a 18 x 18 size 304 stainless steel wire mesh.

Advantech ACP-4010

Cards supported (maximum)	7
Part number	ACP-4010MB-00BE/ACP-4010MB-00C (includes chassis and standard 82 CFM chassis fans)
Power supply	750 W redundant power supply (Advantech part#: RPS8-750ATX-XE)
Power supply bracket	Standard
Fan	Two 120 mm x 120 mm x 25 mm 120 CFM or 150 CFM fans (must upgrade from 82 CFM standard fans to 120 CFM or 150 CFM fans)
Supported motherboards	<ul style="list-style-type: none"> ▪ Advantech ASMB-815 ▪ ASUS PRO WS X299 SAGE II ▪ ASUS WS C621E SAGE
Notes	<ul style="list-style-type: none"> ▪ Power supply is not included with the chassis. It must be purchased separately. ▪ The standard 82 CFM chassis fans must be replaced with two 120 mm x 120 mm x 25 mm 120 CFM or 150 CFM fans that must be purchased separately. ▪ The chassis fans are connected directly to the motherboard and must run at full speed. To change the fan speed, go to the system BIOS main page (EZ mode) → select QFan Control → select the header to which the fans are connected → change from Standard to Full Speed and apply the changes. ▪ Two dust protection sponge filters present on the front door and in front of the fans must be removed for proper system ventilation. ▪ With 120 CFM fans: <ul style="list-style-type: none"> ▪ D1400 controller: The ambient temperature must not exceed 35 degrees centigrade. ▪ With 150 CFM fans: <ul style="list-style-type: none"> ▪ Wired mesh filter can be used in front of the chassis with 150 CFM fans only and the ambient temperature must not exceed 35 degrees centigrade. ▪ Filter requires a 18 x 18 size 304 stainless steel wire mesh.

Advantech IPC 623

Cards supported (maximum)	14
Part number	IPC-623BP-1KZC (for single power supply; includes chassis, fans and 1200 W power supply)
Power supply	1200 W Power Supply (Part#: 96PS-A1K2WPS2; included with the chassis for IPC-623BP-1KZC)
Power supply bracket	Standard
Fan	Three 12 cm /150 CFM fans are included with the chassis
Supported motherboards	<ul style="list-style-type: none"> ▪ Advantech PCE-5B12 (BP)/PCE-7129 (SHB) ▪ Advantech PCE-5B12 (BP)/PCE-7131 (SHB) ▪ Advantech PCE-5B19 (BP)/PCE-7129 (SHB) ▪ Advantech PCE-5B19 (BP)/PCE-7131 (SHB)
Notes	<ul style="list-style-type: none"> ▪ Choose a power cord with IEC C19 plug for the IPC-623BP-1KZC chassis model. ▪ All the dust protectors from the front as well as the sides of the chassis must be removed. ▪ The chassis fans must run at full speed.

Chenbro RM41300 FS81

Cards supported (maximum)	7
Part number	RM41300-FS81 (includes chassis and fans. Power supply is not included.)
Power supply	750 W (Part#: Corsair RM750X / Part#: EVGA SuperNOVA 750 G3) 850 W (Part#: EVGA Supernova 850G3) 1200 W (Enermax Revolution D.F.2 1200 W; Part#: ERS1200EWT)
Power supply bracket	Standard
Fan	<ul style="list-style-type: none"> ▪ One 120 mm x 120 mm x 25 mm 85.5 CFM front fan ▪ Two 80 mm x 80 mm x 25 mm 39 CFM rear fans ▪ Two 120 mm x 120 mm x 25 mm 85.5 CFM fans on the lid
Supported motherboards	<ul style="list-style-type: none"> ▪ Asrock C621A WS ▪ Asrock Rack ROMED8-2T ▪ ASUS Pro WS C621-64L SAGE/10G ▪ ASUS Pro WS W790E-SAGE SE ▪ ASUS Pro WS X299 SAGE II ▪ ASUS WS C422 PRO/SE ▪ ASUS WS C422 SAGE/10G ▪ ASUS WS C621E SAGE ▪ Gigabyte C246-WU4 ▪ Gigabyte MU72-SU0 ▪ MSI TRX40 PRO 10G
Notes	<ul style="list-style-type: none"> ▪ The chassis fans must run at full speed in the system BIOS. ▪ Only the front chassis fan that comes with the Chenbro chassis must be changed to: <ul style="list-style-type: none"> ▪ 120 mm x 120 mm x 25 mm 113 CFM (D1400 controller). ▪ The dust protection filter in the front door must be removed for proper system ventilation.

PCICase IPC-C4FB-H chassis

Cards supported (maximum)	7
Part number	IPC-C4FB-H
Power supply	800 W redundant power supply. Part#: PIST1080-EPSH-80 (not included with the chassis)
Power supply bracket	Standard
Fan	Three 92 mm x 92 mm x 38 mm higher airflow 141 CFM middle fans (Sanyo Denki part#: 9GA0912P1H03; not included with the chassis)
Supported motherboards	<ul style="list-style-type: none"> ▪ ASUS Pro WS C621-64L SAGE/10G ▪ ASUS Pro WS X299 SAGE II ▪ ASUS WS C422 PRO/SE ▪ ASUS WS C422 SAGE/10G ▪ Gigabyte C246-WU4 ▪ Gigabyte MU72-SU0 ▪ MSI TRX40 PRO 10G ▪ Supermicro C9Z390-PGW ▪ Supermicro C9Z490-PG ▪ Supermicro H11SSL-i
Notes	<ul style="list-style-type: none"> ▪ Replace the middle chassis fans that come standard with three higher airflow 92 mm x 92 mm x 38 mm 141 CFM fans. ▪ Power supply must be purchased separately.

Rackmaster 20 slot chassis

Cards supported (maximum)	14
Part number	<ul style="list-style-type: none"> 010-0163 (includes chassis, fans and 800 W redundant power supply) 010-0164 (includes chassis, fans, 800 W redundant power supply and motherboard from the supported list) 010-0165 (includes chassis, fans, and 1200 W single power supply) 010-0166 (includes chassis, fans, 1200 W single power supply and motherboard from the supported list)
Power supply	800 W redundant power supply /1200 W single power supply included with the chassis
Power supply bracket	Standard
Fan	Three 150 CFM fans are included with the chassis
Supported motherboards	<ul style="list-style-type: none"> Advantech PCE-5B12 (BP)/PCE-7129 (SHB) Advantech PCE-5B12 (BP)/PCE-7131 (SHB) Advantech PCE-5B19 (BP)/PCE-7129 (SHB) Advantech PCE-5B19 (BP)/PCE-7131 (SHB)

Rosewill RSV-L4000U

Cards supported (maximum)	7
Part number	Rosewill RSV-L4000U (includes bare-bone chassis only)
Power supply	1200 W (Enermax Revolution D.F.2 1200 W; Part#: ERS1200EWT)
Power supply bracket	Standard
Fan	<ul style="list-style-type: none"> 2 x 120 mm x 120 mm x 25 mm standard front fans included with the chassis 3 x 120 mm x 120 mm x 25 mm 113 CFM front fans (replace the three standard front fans inside the chassis with 113CFM fans purchased separately; Part#: Delta AFB1212SH) 2 x 80 mm x 80 mm x 25 mm standard fans included with the chassis
Supported motherboards	<ul style="list-style-type: none"> Asrock C621A WS Asrock Rack ROMED8-2T Asus Pro WS W790E-SAGE SE Asus Pro WS X299 SAGE II Asus WS C422 PRO/SE Asus WS C422 SAGE/10G Asus WS C621E SAGE Gigabyte C246-WU4 Gigabyte MU72-SU0 Gigabyte WRX80-SU8-IPMI (rev. 1.0) MSI TRX40 PRO 10G
Notes	<ul style="list-style-type: none"> Power supply isn't included with the chassis. The three front fans inside the chassis must be purchased separately. Use 3 x 120 mm x 120 mm x 25 mm 113 CFM fans.

Sliger CX4170a

Cards supported (maximum)	7
Part number	Sliger CX4170a (includes bare-bone chassis only)
Power supply	1000 W (EVGA SuperNOVA 1000 GT; Part#: 220-GT-1000-X1)
Power supply bracket	Standard
Fan	<ul style="list-style-type: none"> Three 120 mm x 120 mm x 25 mm 113 CFM front fans (purchased separately; Part#: Delta AFB1212SH)
Supported motherboards	<ul style="list-style-type: none"> ASUS WS Pro WRX80E-SAGE SE WIFI
Notes	<ul style="list-style-type: none"> The system fan must be set at full speed. Power supply isn't included with the chassis Chassis front fans must be purchased separately. Use three 120 mm x 120 mm x 25 mm 113 CFM fans.

Supermicro CSE-747BTS-R2K20BP chassis

Cards supported (maximum)	7
Part number	CSE-747BTS-R2K20BP (includes chassis, 2200 W redundant power supply, and fans)
Power supply	2200 W redundant, model PWS-2K20A-1R
Power supply bracket	Standard
Fan	<ul style="list-style-type: none">▪ Two 92 mm x 92 mm x 38 mm 109.7 CFM front fans (Supermicro part#: FAN-0114L4, included with the chassis)▪ Two 92 mm x 92 mm x 38 mm 150 CFM middle fans (Supermicro part#: FAN-0138L4, included with the chassis)▪ Two 80 mm x 80 mm x 38 mm 68.3 CFM rear fans (Supermicro part#: FAN-0082L4, included with the chassis)
Supported motherboards	<ul style="list-style-type: none">▪ Supermicro X11SPA-TF/X11SPA-T▪ Supermicro X12SPA-TF▪ Supermicro X13SWA-TF
Notes	<ul style="list-style-type: none">▪ The system fan speed must be set to HeavyIO mode in IPMI.▪ Optional rack-mount kit mounting rails are available (Supermicro part#: MCP-290-000590B).

Supermicro SuperChassis 842XTQ-R606B

Cards supported (maximum)	4
Part number	CSE-842XTQ-R606B (includes chassis, 600 W redundant power supply, and fans)
Power supply	600 W redundant, model PWS-606P-1R
Power supply bracket	Standard
Fan	<ul style="list-style-type: none">▪ One 92 x 92 x 38 mm 120 CFM front fan (included with the chassis)▪ Two 80 x 80 x 38 mm 68.3 CFM rear fans (included with the chassis)
Supported motherboards	<ul style="list-style-type: none">▪ Supermicro C9Z390-PGW▪ Supermicro C9Z490-PG▪ Supermicro H11SSL-i
Notes	The chassis fans must run at full speed.

Supermicro SuperChassis 842XTQC-R804B

Cards supported (maximum)	7
Part number	CSE-842XTQC-R804B (includes chassis, 800 W redundant power supply, and fans)
Power supply	800 W redundant, model PWS-804P-1R
Power supply bracket	Standard
Fan	<ul style="list-style-type: none"> ▪ One 92 x 92 x 38 mm 120 CFM front fan (Supermicro part#: FAN-0097L4, included with the chassis) ▪ Two 80 x 80 x 38 mm 103.1 CFM rear fans (Supermicro part#: FAN-0180L4, included with the chassis)
Supported motherboards	<ul style="list-style-type: none"> ▪ Asrock C621A WS ▪ ASUS Pro WS C621-64L SAGE/10G ▪ ASUS Pro WS W790E-SAGE SE ▪ ASUS Pro WS X299 SAGE II ▪ ASUS WS C422 PRO/SE ▪ ASUS WS C422 SAGE/10G ▪ Gigabyte C246-WU4 ▪ Gigabyte MU72-SU0 ▪ MSI TRX40 PRO 10G ▪ Supermicro C9Z390-PGW ▪ Supermicro C9Z490-PG ▪ Supermicro H11SSL-i ▪ Supermicro X11SPA-TF/X11SPA-T
Notes	The chassis fans must be set to run at standard speed.

EOL (End of Life) chassis

Portwell 10 slot chassis

Cards supported (maximum)	10
Part number	21-M90104-0012 (includes chassis and fans. Power supply must be ordered separately.)
Power supply	950 W redundant power supply (Portwell part#: 02-527050-0002)
Power supply bracket	Standard
Fan	Three 120 mm x 120 mm x 38 mm fans included with the chassis
Supported motherboards	PBPE-11A-MT (BP) / ROBO-8113VG2AR (SHB)

System ventilation

Without proper system ventilation, the motherboard and add-in cards will operate at elevated temperatures. Continued operation at elevated temperatures will reduce the life expectancy of the overall system. Mechanical components (such as fans), in particular, experience higher failure rates when exposed to elevated temperatures over long periods of time. The system integrator must verify that the system – and the add-in card area in particular – is properly ventilated. The result is a system that runs cooler, has a longer operating life, and offers higher reliability.



Note: To guarantee the longevity of your system and the installed cards, make sure your system is installed in a properly ventilated location. Running Matrox Mura IPX and D-Series cards above the specified temperatures will lead to permanent damage to the cards that won't be covered by the Matrox warranty.

Mura IPX Series – The Mura IPX Series operating temperature is 0 to 45 °C. When a Mura IPX Series card is installed in a properly ventilated system, the temperature of the Mura IPX Series card recorded by the Matrox IPX Utility tool or APIs *must never exceed 100 °C*.

To monitor and record the temperature changes of your Mura IPX Series card, use **Matrox IPX utility tool**. From the Mura CD package, install *Network API SDK.msi*. Then, go to system's *Program Files (x86)\Matrox Graphics Inc\Matrox Network API SDK\Applications* and run the *IPX utility.exe*. From the IPX utility tool window, enter **localhost** to get the temperature of your Mura IPX Series card.

D-Series – The temperature of your D-Series cards should never exceed 90 °C. To retrieve the temperature of your D-Series card, use the Matrox PowerDesk software. From the main interface, click **Help and Troubleshooting** → **Troubleshoot**. Under **Chip temperature data and logging**, you can enable options to monitor the peak temperatures and log the chip temperatures of your D-Series card.

Third-party graphics hardware – Ensure that your third-party graphics hardware remains within the maximum allowed temperature. For more information on how to monitor and record the temperature, or for the temperature requirements of your third party graphics hardware, see your third-party graphics hardware documentation.

Power supply sizing for Matrox D-Series based and third-party based systems

When assembling a system based on D-Series products, the power supply must be sized to provide power for the entire system, including the CPU, all add-in cards, and any peripherals connected. To determine the power supply size, you must consider not only the power requirements of all devices but also the power rails from which the current is being drawn.

Each power supply provides different voltages with varying current load capacities, depending on system usage. For example, a -12V supply (still used in some systems) supports less than 1A of load, whereas a +12V supply, which bears the brunt of the load in modern systems, can easily exceed 50A capacity in many mid-sized power supplies. The remaining voltages (typically, +3.3V, +5V, and +5VSB) fall between these extremes in terms of current load capacity.

Matrox cards, being PCI Express based, draw power primarily from the +12V supply, though a small amount of current is drawn from the +3.3V supply (typically on the order of 1-2A). Since each Matrox SKU has slightly different power supply requirements, using the largest possible current requirement to size the power supply will ensure the power supply is adequate, regardless of the SKUs installed.

To properly size the power supply, the power requirements of all the devices must be added together separately for each supply rail and then the appropriate power supply selected. For example, the D1480 can consume up to approximately 4.3 A from the +12V supply, while Mura IPX consumes approximately 2A. A system integrating the maximum configuration of 4 D1480 cards and 3 Mura-IPX cards would therefore require up to approximately 23.2 A (or $4 \times 4.3A + 3 \times 2A$) from the +12V supply. Note: This is *in addition* to any pre-existing requirements of the motherboard and installed hardware (CPU, hard disk drives, etc.). For example, if the system configuration requires 15A from the +12V supply with no Matrox cards installed, once the Matrox cards are installed the power supply must be capable of providing $15A + 23.2A$ (or 39A, rounding up) on the +12V rail for adequate power supply.

A merely “adequate” power supply, however, isn’t sufficient. Most power supplies operate at optimal efficiency at 50-60% of their rated power load. Continually operating beyond this may cause excessive thermal generation and lead to premature aging of the electronic components. It is common practice to ensure that the power supply can supply additional current beyond what’s required for the system configuration in typical use. For maximum efficiency and reliability, make sure to provide a minimum 50% margin on the power supply rating. In the example above, a system requiring 39A on the +12V rail would require approximately 468W. Assuming another 50W for the +3.3V rail and 10W for the +5V rail, the total system requirements are approximately $468W + 50W + 10W$, for a total of 528W. A 50% margin on the power supply means specifying a supply of 800W that can supply around 59A on the +12V supply.

Providing less margin than specified above may lead to excess heat generation within the power supply and premature wear-out of electronic components, possibly compromising the overall reliability of the product.



Note: The margin provided on the power supply must never be less than 35-40%.

For a common display wall setup that supports up to seven Matrox cards and uses a mid-range Intel CPU, we recommend a minimum power supply of 800W. For larger systems, the power supply must be increased accordingly, taking into account the requirements of the CPU or SHB and backplane/motherboard components.

For third-party graphics hardware, an optional power supply may be required for maximum support. If your power supply has an insufficient number of 6-pin connectors to support the maximum number of third-party graphics hardware, you can order optional power cables. For more information on the power requirements of systems based on third-party graphics hardware, see the documentation for your third-party graphics hardware.

Shipping an integrated system

While shipping an integrated system, make sure that add-in cards are properly installed in the expansion slots and the board bracket is screwed securely to the chassis. Most systems have a board retaining clip to protect cards from shock and vibration. If your system has a board retaining clip, use it to securely clamp the boards into place. For more information, see the user guide for your system or chassis. Follow the system /chassis manufacturer’s guidelines for proper installation, shipment, and transportation of an integrated system. Failure to do so may cause damage to the cards due to shock and vibration during shipping and transportation.

PCI Express® bandwidth considerations in Matrox D-Series and Mura IPX Series based systems

System architecture is an important factor in determining overall capture/display performance with Matrox D-Series and Matrox Mura IPX based systems. While the input resolutions and formats must be taken into account, the system bus-level architecture also plays an important role in determining how to optimize the system to obtain the best possible performance. This section attempts to clarify some of the issues that must be considered when implementing Mura-based Display Wall architectures.

Input source bandwidth requirements

Any capture architecture receives its data from external sources and transfers it to one or more graphic engines for display. The inputs may take many forms: Analog RGB, component video, DVI, or even standard TV inputs using either composite or Y/C signals. Each of these inputs places a different load on the system in terms of quantity of data to be transferred. Each input type is also associated with a default data format: Analog RGB and DVI are typically transferred in 24-bit RGB, whereas composite and Y/C video data are generally transferred in 16-bit YUV. Understanding the different transmission formats and their bandwidth requirements will help guide the integrator in setting up and configuring a Mura-based capture system.

The bandwidth required by any input source can be expressed as follows:

$$BW = Res_x \times Res_y \times fps \times Bytes_{pixel}$$

Where the values *fps* and *Bytes_{pixel}* represent the number of frames per second and the number of bytes taken by each pixel, respectively. In analog RGB, component, and DVI modes, each pixel generally requires 4 bytes. In TV modes (or when data is represented as 16-bit YUV data) each pixel requires 2 bytes.

For example, a high-definition source being captured at 1920×1080p60 requires the following bandwidth:

$$BW_{1080p} = 1920 \times 1080 \times 60 \times 4 \approx 500 \text{ MB/s}$$

An NTSC source at 60 Hz (interlaced) requires the following bandwidth: .

$$BW_{NTSC} = 720 \times 480 \times 30 \times 2 \approx 21 \text{ MB/s}$$



Note: In some cases it may be possible to capture analog RGB or DVI sources and transfer them internally using a 16-bit YUV format. Doing so will reduce the amount of system bandwidth required to transfer the input data; however it will generally also degrade the capture quality (since less data is used to represent each pixel). This option should be used only when necessary and with sources when the quality of input capture can be sacrificed.

Regardless of the resolutions and formats of the various inputs, the available system bandwidth should not be exceeded. Doing so will result in reduced system performance and/or instability.

PCI Express architecture overview

To understand how system architecture plays a role in the available bandwidth, a basic understanding of the PCI-Express architecture is helpful. This section describes very briefly, and in general terms, the PCI-Express architecture with the goal of providing enough background to understand the bandwidth calculations provided later in this discussion.

PCI-Express is a point-to-point serial transmission interface using high-speed differential signaling to enable high-performance transfer of data within systems. The PCI-Express architecture is currently in its third generation, with each generation providing increased performance over its predecessor. The initial specification for PCI-Express defined a 2.5 Gb/s data transfer rate per lane, while the 2nd generation PCI-Express increased the data rate to 5 Gb/s. The 3rd generation of PCI-Express (which is just becoming available in systems at the time of writing this) has further increased the data transfer rate to 8 Gb/s per lane of data. The following table summarizes the data transfer capabilities of the PCI-Express architecture based on generation and link width (the link width is the “size” of the electrical connection between two PCI-Express devices).

The PCI Express specification also defines backward-compatibility between PCI Express devices. That is, a device designed for Gen-3 PCI Express functions at Gen-2 speeds when connected to a Gen-2 device, a Gen-2 device functions at Gen-1 speeds when connected to a Gen-1 device, and so on.

Link width*	PCIe Gen-1	PCIe Gen-2	PCIe Gen-3	PCIe Gen-4	PCIe Gen-5
×1	250 MB/s	500 MB/s	1 GB/s	2 GB/s	4 GB/s
×4	1 GB/s	2 GB/s	4 GB/s	8 GB/s	16 GB/s
×8	2 GB/s	4 GB/s	8 GB/s	16 GB/s	32 GB/s
×16	4 GB/s	8 GB/s	16 GB/s	32 GB/s	64 GB/s

* The link width provides a measure of the data transfer capabilities of the link in a single direction. Since each PCI Express lane contains both an upstream and a downstream link, the effective bandwidth is doubled. The numbers in this table represent the maximum bandwidth available *in each direction*.

For maximizing data transfer capabilities within a system, it is desirable to have the widest lane widths possible throughout the system. An ideal system for Display Wall applications provides all add-in boards with x16 PCI-Express Gen3 links, maximizing throughput at each communication link.

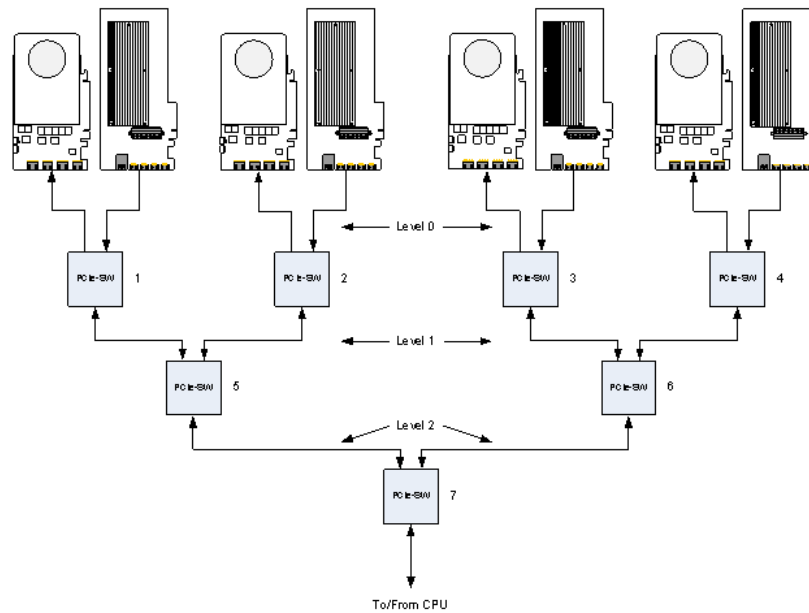

In the diagram above, assume that each PCI Express link is a ×8 connection operating at Gen-3 speeds. Each link thus has a total available throughput of 8 GB/s *in each direction*.



Note: Any combination of data streams being transferred through a given switch that results in the total bandwidth exceeding 8 GB/s will result in reduced system performance (stuttering playback and reduced frame rates).

Now consider the example given below:

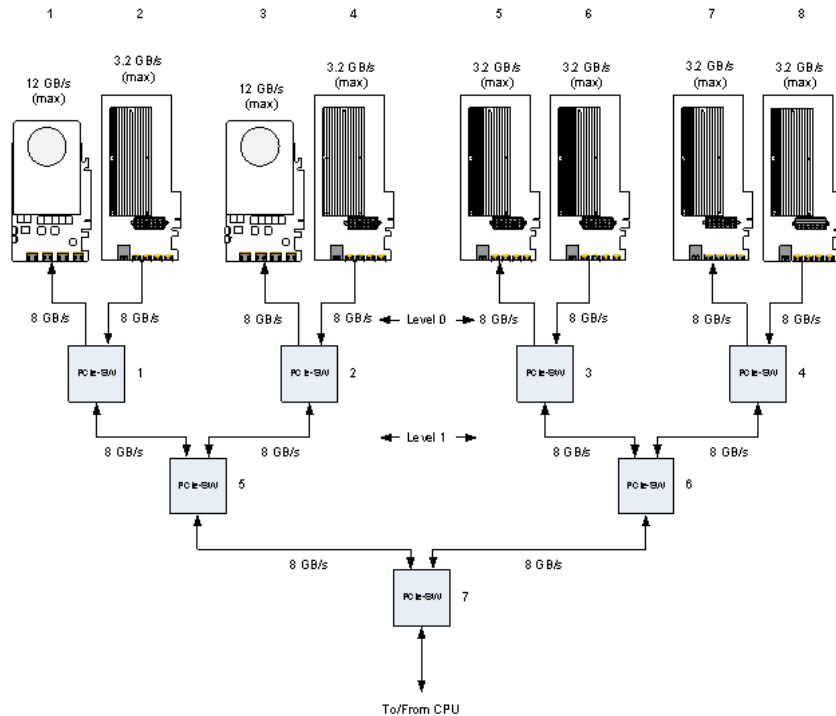

Assuming the transfer of standard HD streams (~500 MB/s), each Mura-IPX card is capable of transmitting its four input streams towards its upstream PCIe switch. In a multi-level PCIe switch architecture, however, transferring streams from multiple cards through the same fabric can cause bottlenecks resulting in stuttered playback and dropped frames. Consider the example above: The data path between input cards #2 and #4 provide a total of 8 GB/s bandwidth towards system memory, and with each card requiring approximately 2 GB/s of bandwidth, there is ample capacity to accommodate the data being transferred. However, if we consider the addition of capture cards #5-8, we see that if we want to transfer 16 HD streams *in addition to* the four initial streams, we require a total of 12 GB/s of bandwidth. Depending on the bandwidth available between the top level PCIe switch and the host (PCIe switch #7), a bottleneck causing reduced performance could be present.

General bandwidth guidelines

It is virtually impossible to provide general guidelines for the installation of Mura cards in a PCIe-based system as there are many different motherboards, and each client's Display Wall implementation is unique. Knowledge of the system architecture and the number and types of inputs is required to optimally place capture cards in the system. By carefully calculating the required bandwidth and ensuring that no data bottlenecks are present at any point in the system, the integrator can guarantee the optimal functioning of the Mura-based Display Wall.

A word about system architecture and performance

One factor that should be taken into account when using Matrox D-Series and Mura-IPX is that in order to improve performance, transfers are performed using system memory, rather than peer-to-peer transfers. In other words, transferring graphical or video data from a capture card to a display source involves first transferring the data to system memory and then from system memory to the display adapter. This is done to address performance limitations imposed by the combination of capture and graphics cards.

It has been assumed until now that systems used for Mura-based Display Walls are based on a switched architecture (that is, the PCI-Express connectors are connected to PCI-Express switches that form the fabric, or backbone, of the system architecture) in order to provide multiple PCIe slots for add-in cards. However, there are many system motherboards that provide a smaller number of slots that do not use a switch-based architecture, but rather use lane-based architecture to provide multiple PCIe slots. In some cases, there are a fixed number of lanes available from the host chipset that can be “allocated” among the various physical PCIe slots, depending on the presence of an adapter (for example, a system may permit a specific slot to be configured in x16 mode if the adjacent slot is unoccupied, or in x8 mode if an adapter is placed in the adjacent slot). In such cases, knowledge of the capabilities of the motherboard is essential to properly configure the system so as to maximize the overall performance.

Contact us

The Matrox Video Web site has product literature, press releases, technical material, a sales office list, trade show information, and other relevant material. Visit us at video.matrox.com.

If you have any questions or comments about our products or solutions, contact us at <https://video.matrox.com/en/forms/contact/general>.

You can get technical assistance by contacting Matrox Video technical support at dwcsupport@matrox.com.

Disclaimer

Information in this document may contain technical inaccuracies or typographical errors. Information may be changed or updated without notice. Matrox reserves the right to make improvements and/or changes in the products, programs and/or specifications described in this information at any time without notice. All trademarks and trade names, service marks and logos referenced herein belong to their respective owners.

ASUS Trademark is either a US registered trademark or trademark of Asustek Computer Inc. in the United States and/or other countries. Reference to any ASUS products, services, processes, or other information and/or use of ASUS Trademarks does not constitute or imply endorsement, sponsorship, or recommendation thereof by ASUS.

Dell and Precision are trademarks or registered trademarks of Dell Inc.

DisplayPort is a trademark of VESA.

HDMI is a registered trademark of HDMI Licensing, LLC in the United States and/or other countries.

HP is a registered trademark of the Hewlett-Packard Development Company, L.P. in the U.S. and other countries.

Intel, Core, and Xeon are trademarks or registered trademarks of Intel Corporation in the U.S. and/or other countries.

Linux is a registered trademark of Linus Torvald in the United States and in other countries.

Microsoft and Windows are either registered trademarks or trademarks of Microsoft Corporation in the United States and/or other countries.

NVIDIA is a registered trademark of NVIDIA Corporation.

OpenCL is a trademark of Apple Inc.

OpenGL is a trademark or registered trademark of Silicon Graphics, Inc. in the United States and/or other countries worldwide.

PCIe and PCI Express are registered trademarks and/or service marks of PCI-SIG.

Copyright © 2024 Matrox is a registered trademark of Matrox Graphics Inc. All rights reserved.

Matrox Graphics Inc.

1055 Saint Regis Boulevard
Dorval, Quebec, Canada H9P 2T4
(514) 822-6000

video@matrox.com
<https://video.matrox.com>

